



The partition wall system for unlimited transparency

FrameTec Select 2.0

Elegant look. Quick assembly.

NEW STANDARDS IN TECHNOLOGY, DESIGN AND COMFORT

The FrameTec Select 2.0 glass partition system is a real all-rounder: the elegant, slim frame construction creates open, light-flooded rooms and at the same time maintains discretion in living and office spaces thanks to the sound insulation of up to 37 dB.

The system is characterised by its versatile installation options and stands out with high-quality profiles that are quick and easy to install. Create a new feeling of space with glass walls.

Product highlights

- Stable frame system with secure hold
- Can be flexibly combined with skylight, side panel or as partition wall
- Narrow floor and wall profiles for a uniform look
- Quick installation thanks to clever profile system
- Sound insulation up to 37 dB

If you have any questions, please contact our Customer Services Team:

☎ 0800 616151

✉ info@bohle.ltd.uk





FRAMETEC SELECT 2.0

FrameTec Select 2.0 product information	4 – 7
FrameTec Select 2.0 products	8 – 16

GLASS DOOR FITTINGS

Door hinges	17 – 19
Alea & Olis	20 – 22
Studio Private Line	23 – 25
Door handles	26 – 27

SUPPLEMENTARY PRODUCTS

Additional products	28 – 37
---------------------	---------

SOUND PROTECTION

FAQ and Tips & Tricks	38 – 39
-----------------------	---------

PLANNING ILLUSTRATIONS

FrameTec Select 2.0	40 – 41
Glazing profiles	42 – 43

ASSEMBLY-FRIENDLY PROFILES

With the combination of the two-part and the one-part glazing profile, installation is particularly effortless. The glass is held in the upper one-piece glazing profile during installation and is thus protected against dangerous tipping. The two-part glazing profile, which is mounted on the floor and the wall, consists of a base profile and a plug-in strip, which then fixes the glazing with a wedge seal.

The frame profiles can be used for both glass-wall and glass-glass installations. Simply push the hinge holders into the multi-function channel and then fix the hinges with screws. The sturdy corner connectors ensure that the mitres are held together securely. The door leaf can be used DIN right and DIN left, as no milling for door hinges and striking plate is required in the frame profile. The frame is suitable for 8 - 10.76 mm ESG/VSG doors with 24 mm rebate depth.

- Clever glazing thanks to two-part profiles
- With multi-functional channel for speedy strap fastening
- Pre-cut mitres for optimum impact
- Can be used DIN right and DIN left



A REAL EYE-CATCHER

The diverse installation options are impressive: Single or double-leaf doors, combined with fanlights and side panels are just as possible as partitions with T-joints or across corners - FrameTec Select 2.0 offers you almost unlimited freedom in terms of design concept.

Choose the right colour for every room style with stainless steel effect, aluminium-coloured and matt black finishes and see the high quality, filigree profiles for yourself. Wall and floor profiles are all equally narrow and thus ensure a continuous line. This makes the design look particularly harmonious and light.

For the modern industrial look, which is mainly based on black mechanical elements, we recommend crittal effect strips. They are glued between the existing profiles, enable the visual subdivision of large glass surfaces and set strong accents.

- High-quality appearance thanks to filigree profiles
- Matching surface for every style
- Stick-on decorative profiles for more individuality

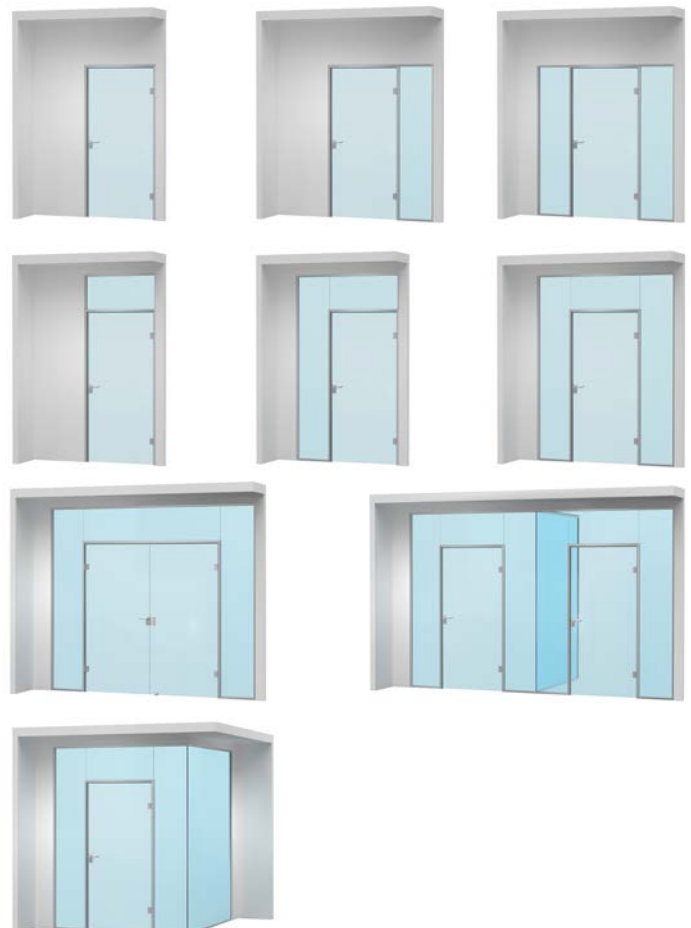

5 STEPS TO YOUR FRAMETEC SELECT 2.0 SOLUTION

1. Take measurements

Determine the smallest clear dimensions (height and width) and measure from masonry to masonry at several points.

2. Select the installation type

Depending on the installation (construction height, glass statics, etc.), determine the door position, the door width, the door height and the opening direction. A sketch will help you to do this.

3. Determine the glass thickness

Take into account the glass statics and the required sound insulation.

4. Choose a finish

Stainless steel effect, aluminium-coloured and black matt finishes are available to suit every style of room.



5. Select the accessories

Finalise the glass system with the right choice of locks, hinges, door handles and the like.

Technical data

Material	Aluminium
max. recommended installation height	3000 mm
max. installation length	unlimited
max. door height	2700 mm
max. door width	1000 mm
Glass thickness door	8 - 10.76 mm
Glass thickness fixed part/skylight	8 - 13.52 mm



FIRST-CLASS SOUND INSULATION FOR MORE COMFORT

Protection against noise is becoming increasingly important when planning rooms. The FrameTec Select 2.0 glass partition wall system enables you to separate individual rooms in terms of sound insulation while at the same time preserving the open and bright feeling of the room. The official sound insulation test of the ift Rosenheim test institute certifies that the system has a sound insulation of up to 37 dB. The partition wall system is therefore equally suitable for private, hospital and office rooms.

Sound insulation dimensions according to DIN 4109

Glass	Superstructure	FrameTec Select 2.0 Test value R_w
10 mm toughened safety glass	Hinged door single-leaf	31 dB
10.76 mm VSG with sound insulation foil	Hinged door single-leaf	36 dB
10 mm toughened safety glass	Hinged door single-leaf / fixed glazing on one side and fanlight	32 dB
10.76 mm VSG with sound insulation foil	Hinged door single-leaf / fixed glazing on one side and fanlight	37 dB

Information on sound insulation and tips & tricks for improving sound insulation can be found on pages 38 and 39.



FrameTec Select 2.0 has been tested by ift Rosenheim according to DIN 4109.

FrameTec Select 2.0

FrameTec Select 2.0 aluminium frame complete sets



FRAME OUTER DIMENSION - DOOR LEAF DIMENSION - FINISH	ART. NO.
901 x 2138 mm · max. 834 x 2097 mm · aluminium coloured anodised E6/EV1	BO 5220801
1026 x 2138 mm · max. 959 x 2097 mm · aluminium coloured anodised E6/EV1	BO 5220802
1067 x 2750 mm · max. 1000 x 2709 mm · aluminium coloured anodised E6/EV1	BO 5220803
901 x 2138 mm · max. 834 x 2097 mm · stainless steel effect anodised E1/C31	BO 5220804
1026 x 2138 mm · max. 959 x 2097 mm · stainless steel effect anodised E1/C31	BO 5220805
1067 x 2750 mm · max. 1000 x 2709 mm · stainless steel effect anodised E1/C31	BO 5220806
1026 x 2138 mm · max. 959 x 2097 mm · powder coated matt black RAL 9005	BO 5220807
1067 x 2750 mm · max. 1000 x 2709 mm · powder coated matt black RAL 9005	BO 5220808

Material	Aluminium
----------	-----------

i Glass thickness: door leaf toughened safety glass 8 - 10 mm, toughened safety glass 8.76 - 10.76 mm; fixed part/ fanlight toughened safety glass 8 - 12 mm; toughened safety glass 8.76 - 13.52 mm · Seal colour grey (in aluminium colour and stainless steel effect sets) · Seal colour black (in powder-coated matt black RAL 9005 sets) · Profiles mitred and can be shortened individually · Basic and wedge seals for fixed and skylight glazing, depending on glass thickness, please order separately · please order strike plate separately · when using stainless steel door hinges (BO 5206654, BO 5206654B) please order hinge mounting plates BO 5220814 separately · From a door height >2200 mm we recommend using 3 hinges · Note: The glass processing of the door hinges deviates from the standard. · Note: The cover profile must be shortened on site. · Note: Double-leaf doors can be realised with single components · Note: When using “non-system” glazing profiles, we recommend fixing the frame with floor fixing bracket BO 5220818 · Notes on locks: for 10 - 10.76 mm glass thickness, a lock with milled latch and bolt head is required (e.g. lock BO 5206590 ff. or replacement latch BO 5206804 for Studio lock). e.g. lock BO 5206590 ff. or replacement latch BO 5206804 for Studio lock); when using Studio Private Line PZ lock, a non-locking lock is required (e.g. BO 5206762, BO 5206763, BO 5206754); Select 2.0 frame is not compatible with Alea / Olis WC lock.

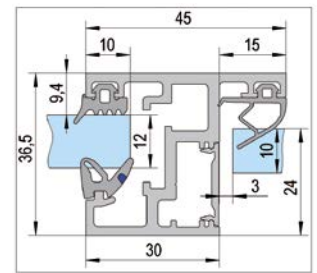
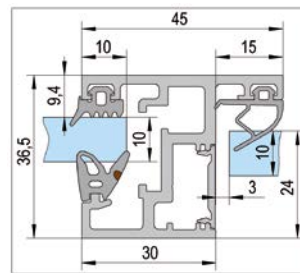
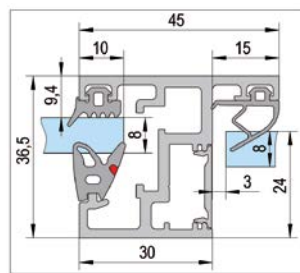
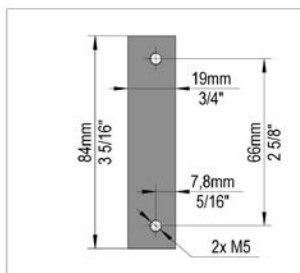
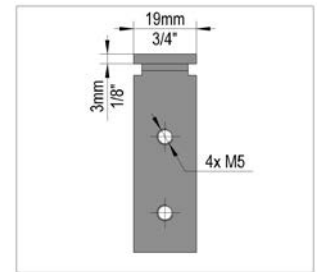
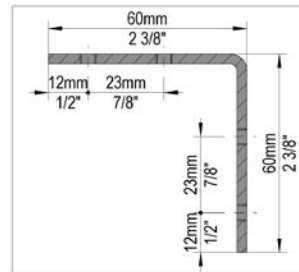

INCLUDED IN DELIVERY:

- 3x Frame profiles
- 3x Cover profiles
- 2x Corner connectors
- 1x Stop seal
- 2 or 3 hinge mounting plates for aluminium frame hinge (BO 5206662, BO 5206663, BO 5206664, BO 5206668, BO 5206669)

FrameTec Select 2.0 frame profile incl. cover profile



FINISH	ART. NO.
aluminium coloured anodised E6/EV1	BO 5220811
stainless steel effect anodised E1/C31	BO 5220812
powder-coated matt black RAL 9005	BO 5220810
Material	Aluminium
Length	5600 mm

i Glass thickness: door leaf ESG 8 - 10 mm, VSG 8.76 - 10.76 mm; fixed part/ Top light ESG 8 - 12 mm; VSG 8.76 - 13.52 mm · from a door height >2200 mm we recommend using 3 hinges · Note: The glass processing of the door hinges deviates from the standard. · Note: The cover profile must be shortened on site. · Please order individual components such as seals, hinge mounting plates, striking plate, corner connectors separately

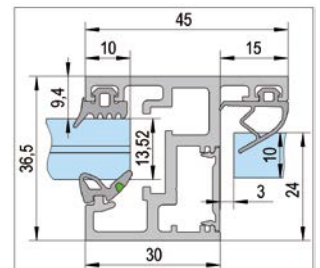
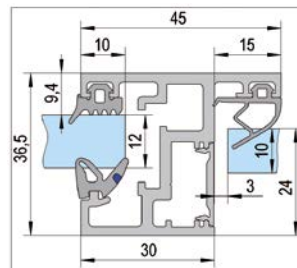
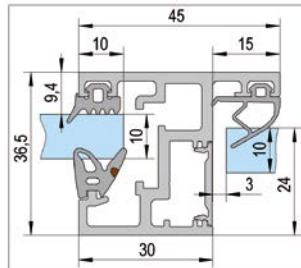
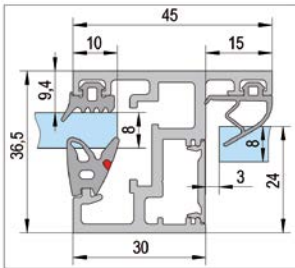

FrameTec Select 2.0 two-part glazing profile



FINISH	ART. NO.
Aluminium coloured anodised E6/EV1	BO 5220840
Stainless steel effect anodised E1/C31	BO 5220841
powder-coated matt black RAL 9005	BO 5220842
<hr/>	
Material	Aluminium
Length	5000 mm

i Glass thickness ESG 8 - 12 mm, VSG 8.76 - 13.52 mm · Please order corner connectors and gaskets separately depending on glass thickness · Gasket is available in black or grey · The mitred or butted glazing profiles are supplied with corner connectors BO 5220815 connected. · Together with the one-piece glazing profile (BO 5220843 - 45), various installation combinations can be realised

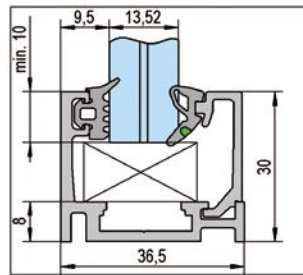
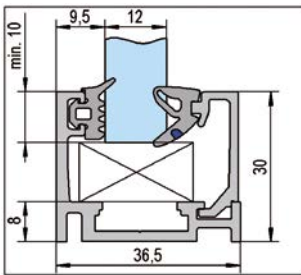
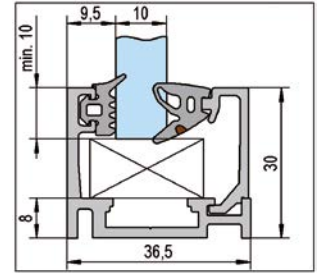
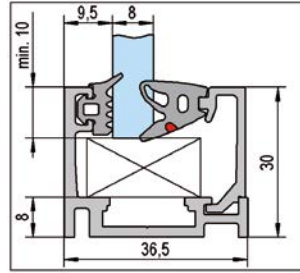

FrameTec Select 2.0 glazing profile



FINISH	ART. NO.
Aluminium coloured anodised E6/EV1	BO 5220843
Stainless steel effect anodised E1/C31	BO 5220844
powder-coated matt black RAL 9005	BO 5220845
<hr/>	
Material	Aluminium
Length	5000 mm

i Glass thickness ESG 8 - 12 mm, VSG 8.76 - 13.52 mm · Please order corner connectors and gaskets separately depending on glass thickness · Gasket is available in black or grey · The mitred or butted glazing profiles are supplied with corner connectors BO 5220815 connected. - Together with the two-part glazing profile (BO 5220840 - 42), various installation combinations can be realised.

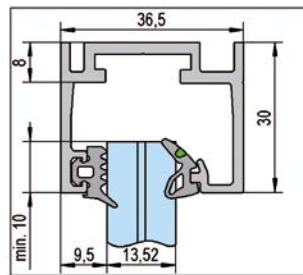
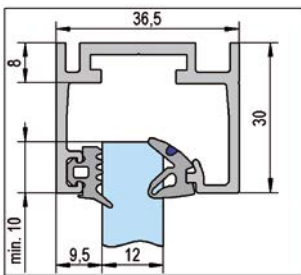
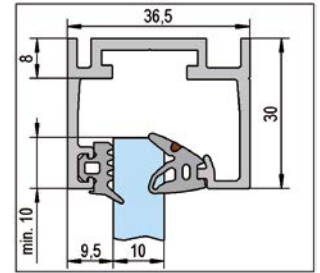
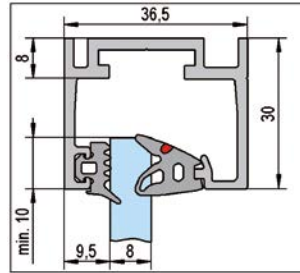

FrameTec Select 2.0 basic seal for fixed and skylight glazing



COLOUR	ART. NO.
grey	BO 5220821
black	BO 5220822
Length 7000 mm	

i Glass thickness ESG 8 - 12 mm, VSG 8.76 - 13.52 mm · please order matching wedge seal separately depending on selected glass thickness

FrameTec Select 2.0 wedge seal for fixed and fanlight glazing



COLOUR · DESCRIPTION	ART. NO.
grey · glass thickness ESG 8 mm, VSG 8.76 mm	BO 5220823
black · glass thickness ESG 8 mm, VSG 8.76 mm	BO 5220824
grey · glass thickness ESG 10 mm, VSG 10.76 mm	BO 5220825
black · glass thickness ESG 10 mm, VSG 10.76 mm	BO 5220826
grey · glass thickness ESG 12 mm, VSG 12.76 mm	BO 5220827
black · glass thickness ESG 12 mm, VSG 12.76 mm	BO 5220828
grey · glass thickness VSG 13.52 mm	BO 5220829
black · glass thickness VSG 13.52 mm	BO 5220830
Length 7000 mm	

i please order matching base gasket separately

FrameTec Select 2.0 stop seal



COLOUR	ART. NO.
grey	BO 5220831
black	BO 5220832
Length 7000 mm	

i Glass thickness ESG 8 - 10 mm, VSG 8.76 - 10.76 mm

Glass thickness (mm)	8 - 8.76		10 - 10.76		12 - 12.76		13.52	
Colour	grey	black	grey	black	grey	black	grey	black
Stop seal	BO 5220831	BO 5220832	BO 5220831	BO 5220832	-	-	-	-
Base seal	BO 5220821	BO 5220822	BO 5220821	BO 5220822	BO 5220821	BO 5220822	BO 5220821	BO 5220822
Wedge seal	BO 5220823	BO 5220824	BO 5220825	BO 5220826	BO 5220827	BO 5220828	BO 5220829	BO 5220830
	●	●	●	●	●	●	●	●

FrameTec Select 2.0 corner connector



i The stable corner connectors ensure that the frame and the two-part FrameTec Select 2.0 glazing profiles are held together securely.

INCLUDED IN DELIVERY:

1x Corner connector

ART. NO.

BO 5220815

Material

Aluminium

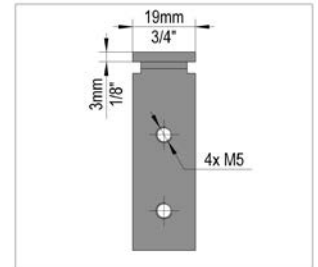
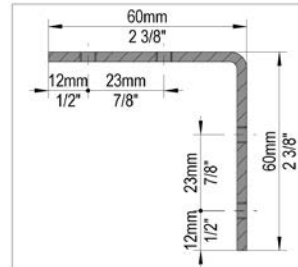

FrameTec Select 2.0 floor mounting bracket



i The stable floor mounting brackets ensure that the frame is securely anchored in the floor.

INCLUDED IN DELIVERY:

2x Floor mounting brackets

ART. NO.

BO 5220818

Material

Aluminium

Finish

raw

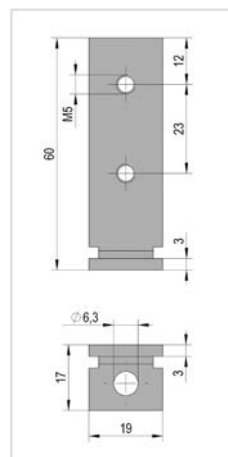

FrameTec Select 2.0 longitudinal connector



i The stable longitudinal connectors for 180° joints ensure that the glazing profiles are held together securely, making installation easier.

INCLUDED IN DELIVERY:

1x Longitudinal connector 180°

ART. NO.

BO 5220834

Material

Stainless steel

Finish

brushed

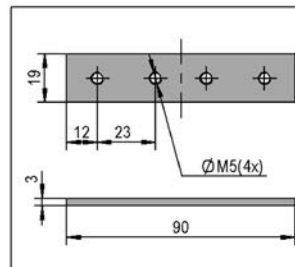

FrameTec Select 2.0 corner connector 90° flat



i The sturdy connectors for 90° corners ensure that the glazing profile mitres are held together securely, making installation easier.

INCLUDED IN DELIVERY:

1x Corner connector 90° flat

ART. NO.

BO 5220833

Material

Stainless steel

Finish

brushed

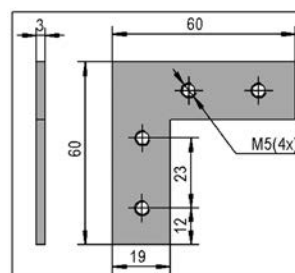

FrameTec Select 2.0 hinge mounting plate for stainless steel frame hinge



ART. NO.

BO 5220814

Material

Aluminium

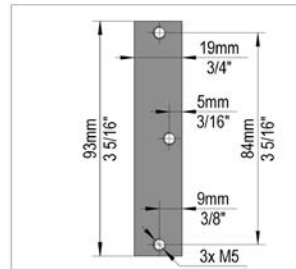

1 From a door height >2200 mm we recommend using 3 hinges · suitable for stainless steel frame hinge BO 5206654, BO 5206654B

INCLUDED IN DELIVERY:

- 1x Tape recording plate
- 3x Screws M5

FrameTec Select 2.0 hinge mounting plate for aluminium frame hinge



ART. NO.

BO 5220813

Material

Aluminium

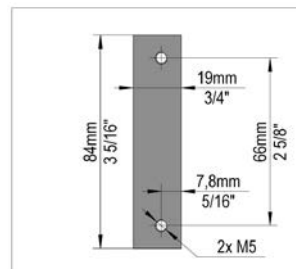

1 From a door height >2200 mm we recommend using 3 hinges · suitable for aluminium frame hinge BO 5206662, BO 5206663, BO 5206664, BO 5206668, BO 5206669

INCLUDED IN DELIVERY:

- 1x Tape recording plate
- 2x Screws M5

FrameTec Select 2.0 strike plate latch



i Sturdy stainless steel strike plate with milled edge · incl. screws

ART. NO.	
	BO 5220744
Material	Stainless steel
Finish	brushed

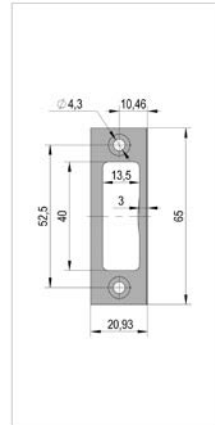

FrameTec Select 2.0 strike plate latch and deadbolt



i Sturdy stainless steel strike plate with milled edge · incl. screws

ART. NO.	
	BO 5220743
Material	Stainless steel
Finish	brushed

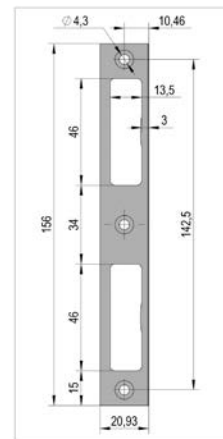



DOOR HINGES



Aluminium coloured



Stainless steel effect



Powder coated matt black RAL 9005

Door hinge with screw-on plate, round



❗ Glass thickness ESG 8, 10, 12 mm, VSG 8.76, 10.76, 12.76 mm · DIN left and right usable

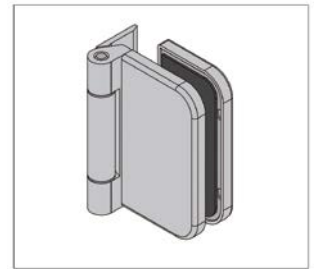
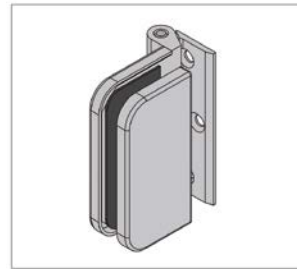
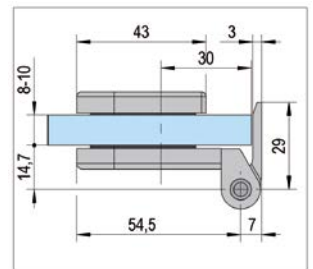
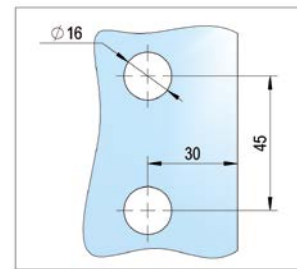
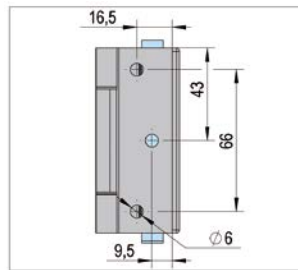
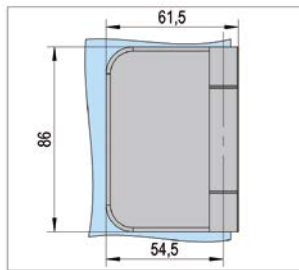

Door hinge with square screw-on plate



❗ Glass thickness ESG 8, 10, 12 mm, VSG 8.76, 10.76, 12.76 mm · DIN left and right usable

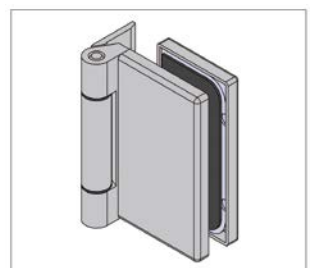
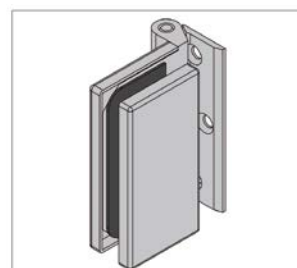
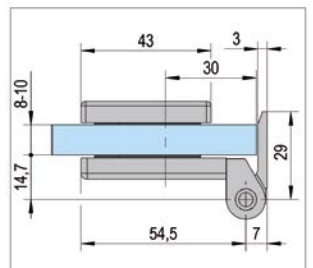
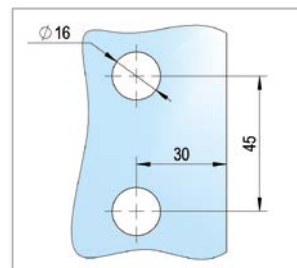
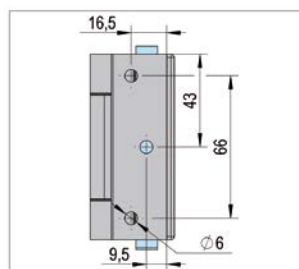
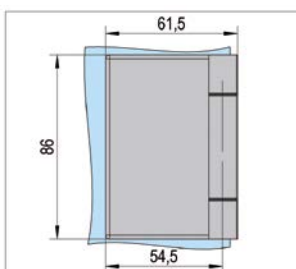

FINISH	ART. NO.
Aluminium coloured anodised E4/EV1	BO 5206664
Stainless steel effect anodised E4/C31	BO 5206663
max. door weight per pair	50 kg
max. door width	1000 mm
Material	Aluminium

FINISH	ART. NO.
Aluminium coloured anodised E4/EV1	BO 5206669
powder-coated matt black RAL 9005	BO 5206662
Stainless steel effect anodised E4/C31	BO 5206668
max. door weight per pair	50 kg
max. door width	1000 mm
Material	Aluminium

Stainless steel door hinge with angular screw-on plate glass wall 90



FINISH	ART. NO.
brushed	BO 5206654
powder-coated matt black RAL 9005	BO 5206654B
max. door weight per pair	80 kg
max. door width	1000 mm
Material	Stainless steel

i Can be used DIN left and right · Glass thickness ESG 8 - 10 mm

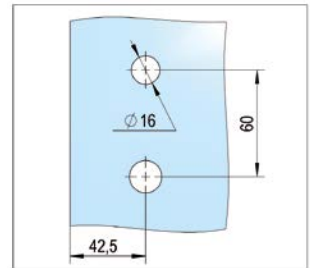
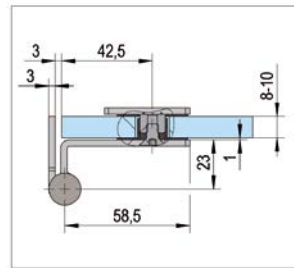
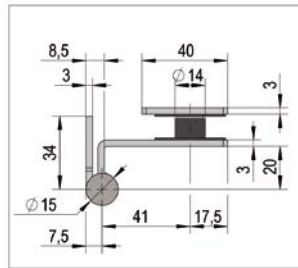
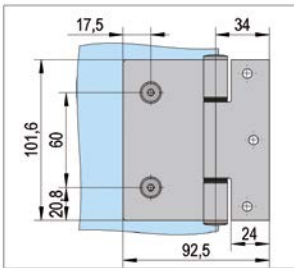
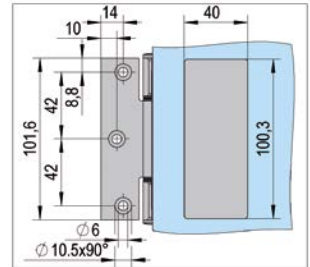



GLASS DOOR LOCKS AND COUNTER BOXES

ALEA & OLIS







Thanks to their reliable and robust quality, the locks and door hinges of the Alea series are the ideal solution for heavily frequented doors in the commercial sector.



Aluminium coloured

Stainless steel effect

Powder coated matt black RAL 9005

ALEA	FINISH	DIN Left GLASS THICKNESS 8 mm	DIN Left GLASS THICKNESS 10 mm	DIN Right GLASS THICKNESS 8 mm	DIN Right GLASS THICKNESS 10 mm
Lock prepared for profile cylinder					
	Aluminium coloured E4/EV1	BO 5206876	BO 5206594	BO 5206877	BO 5206595
	Stainless steel effect E4/C31	BO 5206887	BO 5206596	BO 5206888	BO 5206597
	powder-coated matt black RAL 9005	BO 5206750	BO 5206752	BO 5206751	BO 5206753
Lock unlockable					
	Aluminium coloured E4/EV1	BO 5206872	–	BO 5206873	–
	Stainless steel effect E4/C31	BO 5206883	–	BO 5206884	–
	powder-coated matt black RAL 9005	BO 5206756	BO 5206758	BO 5206757	BO 5206759
Counter box					
	Aluminium coloured E4/EV1	BO 5206880		BO 5206881	
	Stainless steel effect E4/C31	–		–	
	powder-coated matt black RAL 9005	BO 5206747		BO 5206748	
OLIS					
Lock prepared for profile cylinder					
	Aluminium coloured E4/EV1	BO 5206864	BO 5206590	BO 5206865	BO 5206591
	Stainless steel effect E4/C31	BO 5206868	BO 5206592	BO 5206869	BO 5206593
	powder-coated matt black RAL 9005	–	–	–	–
Lock unlockable					
	Aluminium coloured E4/EV1	BO 5206860	–	BO 5206861	–
	Stainless steel effect E4/C31	BO 5206826	–	BO 5206828	–
	powder-coated matt black RAL 9005	–	–	–	–
Counter box					
	Aluminium coloured E4/EV1	BO 5206837		BO 5206839	
	Stainless steel effect E4/C31	–		–	
	powder-coated matt black RAL 9005	–		–	

Technical data

- Glass thickness ESG 8-10 mm, VSG 8.76-10.76 mm
- Tested according to DIN EN 12209 (drop endurance test 500,000 cycles, bolt closing test 100,000 cycles)
- Tested in accordance with DIN EN 1670 (corrosion protection class 3)
- Application in the commercial sector with heavily frequented doors
- Rebate depth 24mm/26mm (glass thickness 8mm/10mm)
- Locks for 8mm glass with noise-reducing whisper latch
- Locks for 10mm glass with shortened latch and bolt head
- Matching profile cylinder (63mm) for flush finish on the clamping plate side
- Bolt exclusion 20mm (2-turn)
- Please order DIN right lock for DIN left counter box and vice versa

Alea Product Details

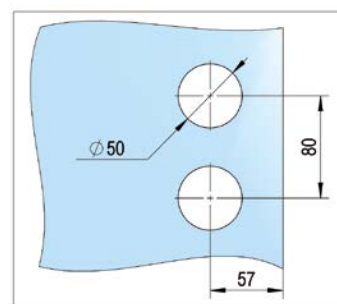
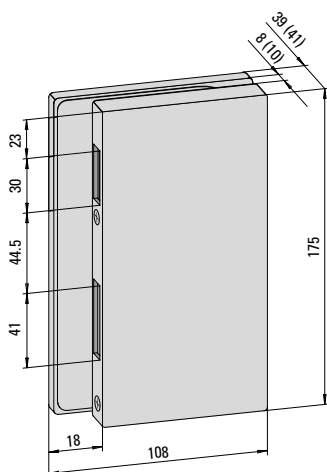
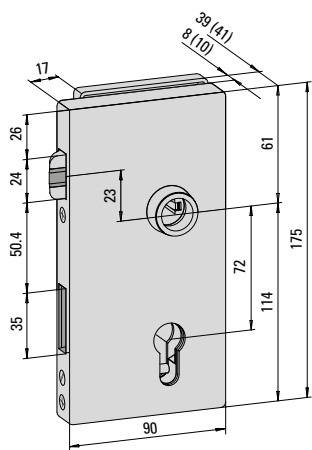

Olis Product Details

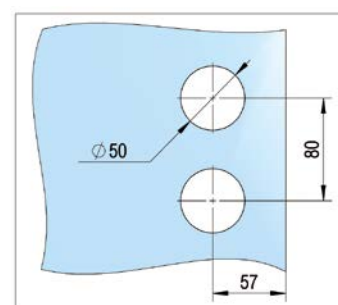
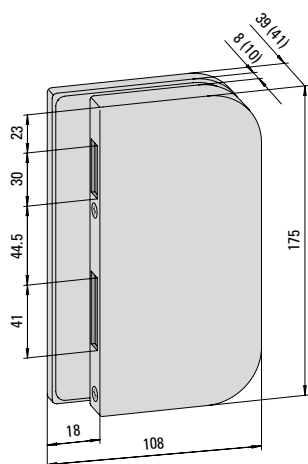
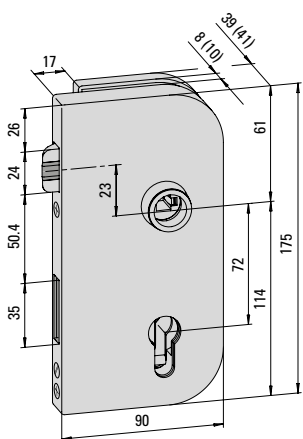



GLASS DOOR LOCKS AND COUNTER BOXES **STUDIO PRIVATE LINE**

The Studio glass door lock impresses with high-quality surfaces and a classic design for interior doors. It offers benefits such as low-wear polyisocyanate springs, a noise-reducing whisper latch, a slim lever handle guide as well as optimum hold of the lever handle pin due to a new clamping nut. Continuous adjustment of the lever handle resistance is also possible.



Aluminium coloured





Stainless steel effect



Powder coated matt black RAL 9005

	FINISH	GLASS THICKNESS 8 mm	GLASS THICKNESS 10 mm
Lock prepared for profile cylinder			
	Aluminium coloured E4/EV1	BO 5206762	BO 5206762*
	Stainless steel effect E4/C31	BO 5206763	BO 5206763*
	powder-coated matt black RAL 9005	BO 5206754	BO 5206754*
	Aluminium coloured E4/EV1	BO 5206788	BO 5206788*
	Stainless steel effect E4/C31	BO 5206789	BO 5206789*
	powder-coated matt black RAL 9005	–	–
Bearded lock			
	Aluminium coloured E4/EV1	BO 5206790	BO 5206790*
	Stainless steel effect E4/C31	BO 5206791	BO 5206791*
	powder-coated matt black RAL 9005	–	–
	Aluminium coloured E4/EV1	BO 5206786	BO 5206786*
	Stainless steel effect E4/C31	BO 5206787	BO 5206787*
	powder-coated matt black RAL 9005	–	–
Lock unlockable			
	Aluminium coloured E4/EV1	BO 5206760	BO 5206760*
	Stainless steel effect E4/C31	BO 5206761	BO 5206761*
	powder-coated matt black RAL 9005	BO 5206803	BO 5206803*
	Aluminium coloured E4/EV1	BO 5206805	BO 5206805*
	Stainless steel effect E4/C31	BO 5206806	BO 5206806*
	powder-coated matt black RAL 9005	–	–
Counter box			
	Aluminium coloured E4/EV1	BO 5206821	
	Stainless steel effect E4/C31	BO 5206822	
	powder-coated matt black RAL 9005	–	
	Aluminium coloured E4/EV1	BO 5206811	
	Stainless steel effect E4/C31	BO 5206812	
	powder-coated matt black RAL 9005	–	

* Replacement latch (art. no. BO 5206804) required - see page 30

	FINISH	GLASS THICK 8 mm	DIN left inwards	DIN right inwards	DIN left outwards	DIN right outwards
Lock WC						
	Aluminium coloured E4/EV1	3	BO 5206772	BO 5206774	BO 5206776	BO 5206778
	Stainless steel effect E4/C31	3	BO 5206773	BO 5206775	BO 5206777	BO 5206779
	powder-coated matt black RAL 9005	–	–	–	–	–
	Aluminium coloured E4/EV1	3	BO 5206764	BO 5206766	BO 5206768	BO 5206770
	Stainless steel effect E4/C31	3	BO 5206765	BO 5206767	BO 5206769	BO 5206771
	powder-coated matt black RAL 9005	–	–	–	–	–

Technical data

- Glass thickness ESG 8-10 mm, VSG 8.76-10.76 mm
- Tested according to DIN EN 12209 (1.5 million closing cycles)
- Tested according to DIN EN 1670 (corrosion protection class 3)
- Application in private living areas or in commercial settings
- Rebate depth 24mm/26mm (glass thickness 8mm/10mm)
- Locks with latch head made of nickel-plated brass
- Noise-reducing whisper latch enclosed loose
- For 10mm glass at 24mm rebate depth a replacement latch BO 5206804 is required
- Matching profile cylinder (61mm) for flush closing on the clamping plate side
- Lockable, non-locking. Bolt exclusion 10mm (1 turn)

Studio Private Line Product Details

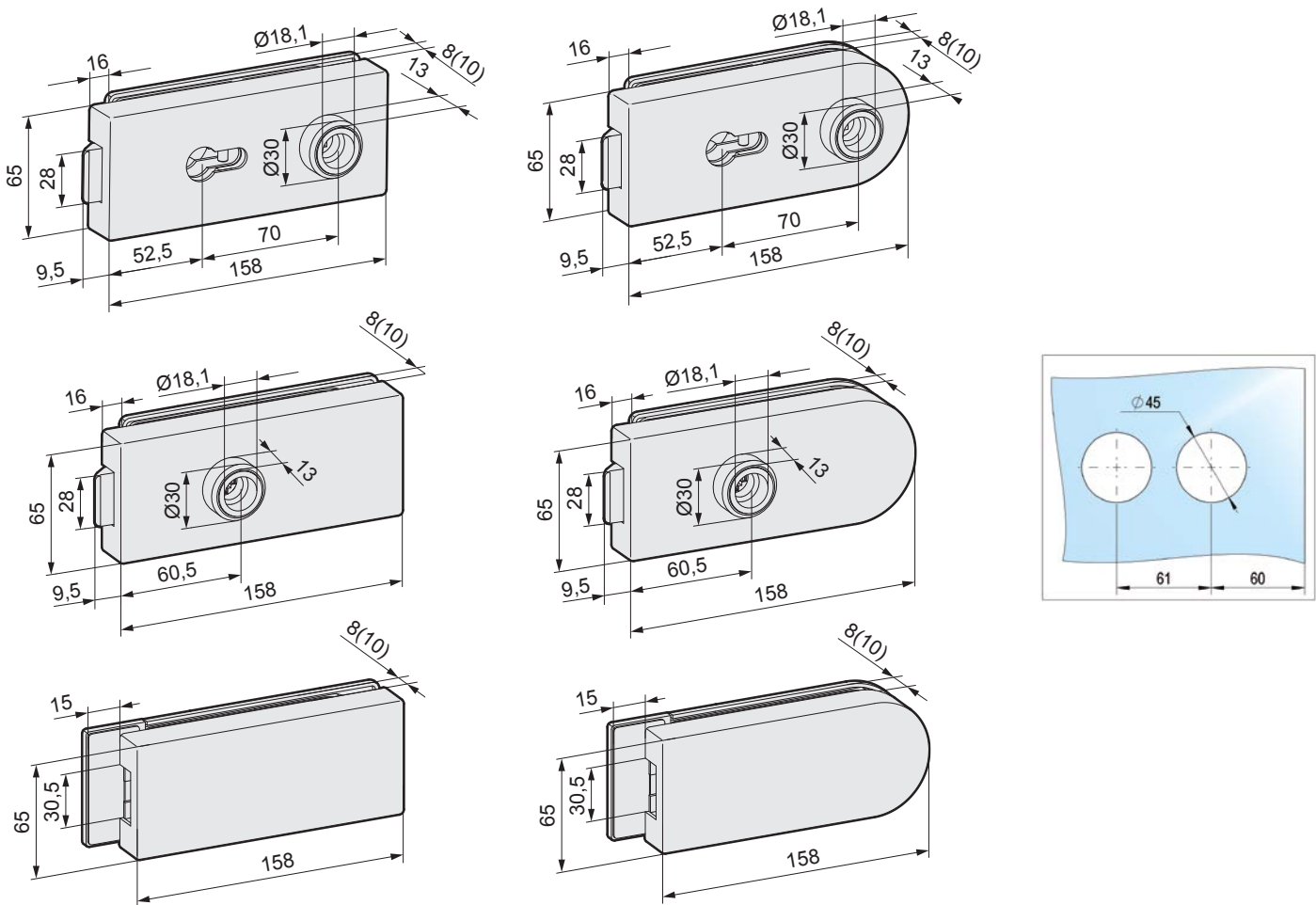

Definition of DIN and opening direction for WC locks with operating knob

Control knob on lock side
(DIN left inwards)

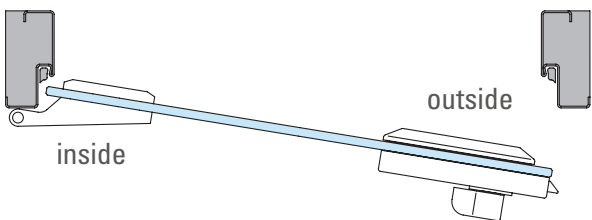

Operating toggle on clamping plate side
(DIN left outwards)

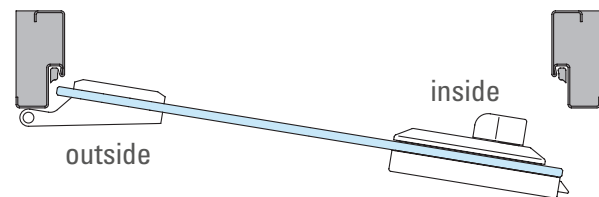

Control knob on lock side
(DIN right inwards)

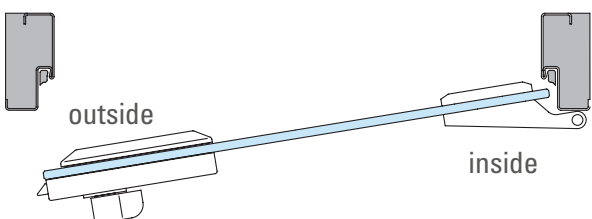

Operating toggle on clamping plate side
(DIN right outwards)

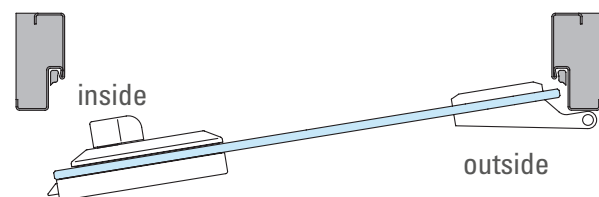

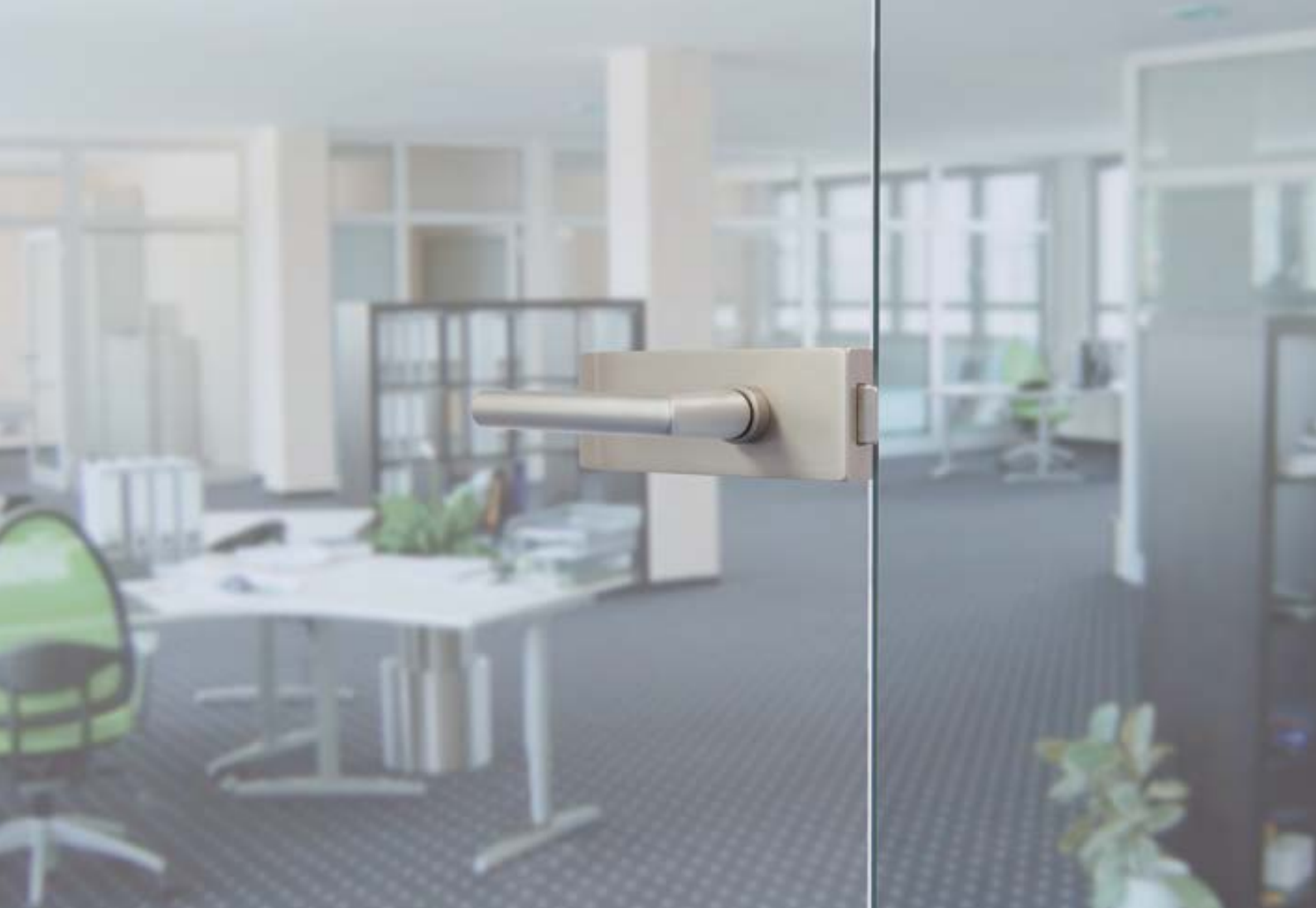

DOOR HANDLES

STUDIO PRIVATE LINE / ALEA / OLIS



Aluminium-coloured anodised E4/EV1

Stainless steel effect anodised E4/C31

Powder-coated matt black RAL 9005

Studio Private Line / Olis / Alea lever handle set, L-shape

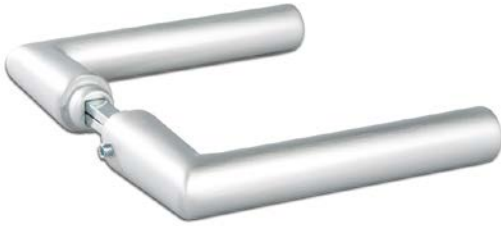

FINISH	ART. NO.
Aluminium coloured anodised E4/EV1	BO 5206845
Stainless steel effect anodised E4/C31	BO 5206846
powder-coated matt black RAL 9005	BO 5206749

Material	Aluminium
----------	-----------

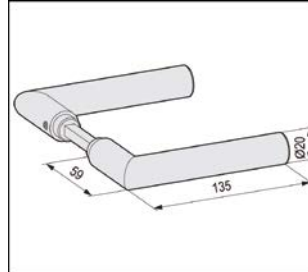

Studio Private Line / Olis / Alea lever handle set, round shape



FINISH	ART. NO.
Aluminium coloured anodised E4/EV1	BO 5206841
Stainless steel effect anodised E4/C31	BO 5206842

Material	Aluminium
----------	-----------

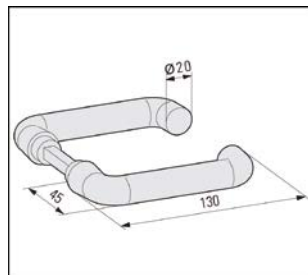

Studio Private Line / Olis / Alea lever handle set, flat oval shape



FINISH	ART. NO.
Aluminium coloured anodised E4/EV1	BO 5206843
Stainless steel effect anodised E4/C31	BO 5206844
powder-coated matt black RAL 9005	BO 5206755

Material	Aluminium
----------	-----------

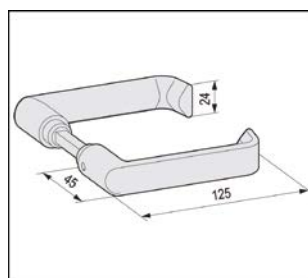



SUPPLEMENTARY PRODUCTS

Industrial-look stick-on profiles

For the modern industrial look, which thrives above all on black metallic elements, we recommend stick-on decorative profiles. They are glued between the existing profiles, and therefore they enable subdivision of large glass surfaces and set strong accents.



	ART. NO.
	BO 5220850
Material	Aluminium
Finish	powder coated matt black RAL 9005
Length	2800 mm

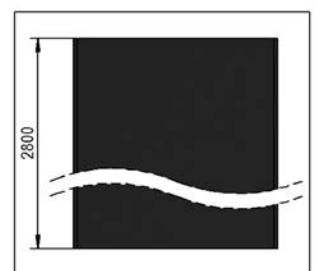
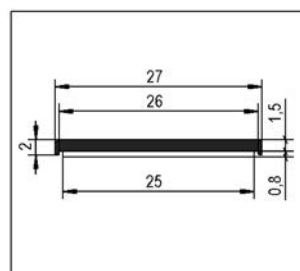

i The decorative profiles are self-adhesive and can be shortened individually. For aligning the profiles, we recommend eccentric stop with suction disc BO 637.1

INCLUDED IN DELIVERY:
5x 2800 mm

Glass door nylon ball catcher

The ball catch is ideal for hinged glass doors that do not require a latch but still need to be closed firmly. This is achieved with the nylon spring ball, which sits in a housing made of nickel-plated die-cast zinc and thus enables easy closing of the door. The material is wear and corrosion resistant. The contact pressure of the glass door on the ball can be adjusted as required using a screw on the underside of the catch. The depth of the ball can be adjusted between 3 and 10 mm to optimally close the air gap between the door and the rebate. The glass door opens and closes almost silently. The catch and screw-on plate are fixed with two screws and are hardly visible when installed.



i When installing in conjunction with a side panel, only glass thicknesses 8-10 mm (ESG/VSG) can be used. · Make sure that there is no contact between the metal housing of the ball catch and the glass side part. · After mounting the side part, the screw for adjusting the spring force is no longer accessible.

	ART. NO.
	BO 5220835
Material	Zinc die-cast
Finish	stainless steel coloured

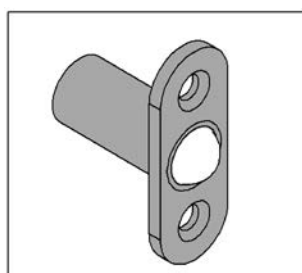
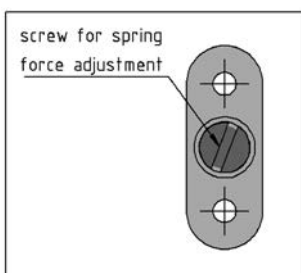
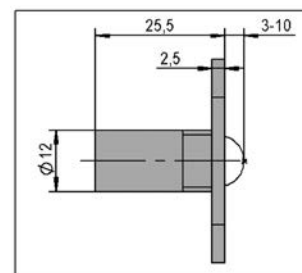
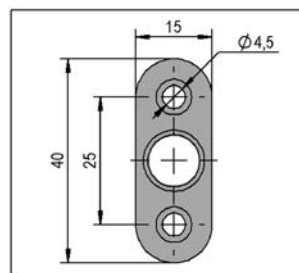

Avoid contact between metal housing and glass side panel

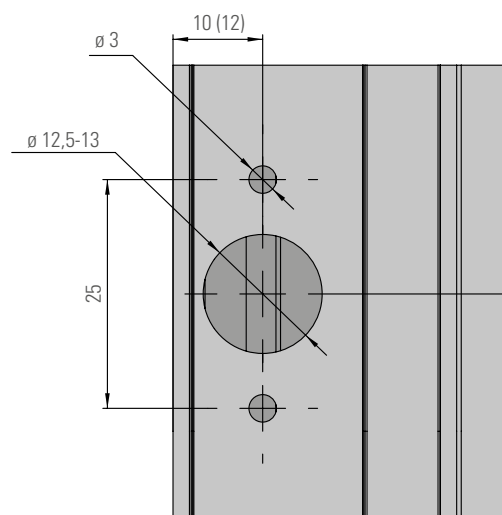
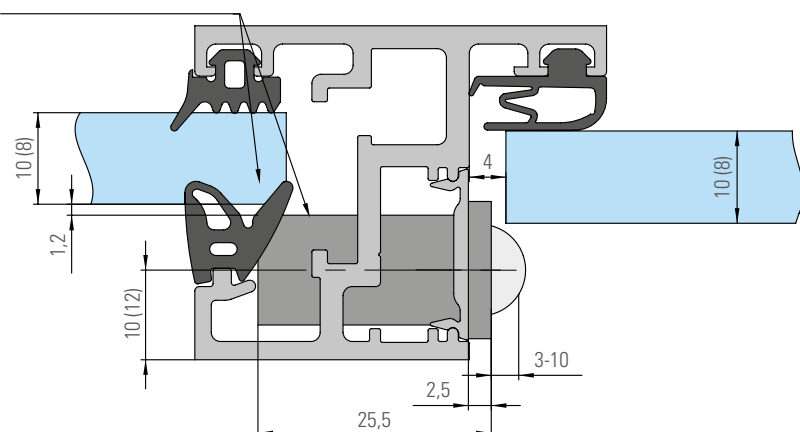

Double profile cylinder

With emergency and danger function - even if a key is inserted in the cylinder from the inside, the cylinder can be operated from the outside. This prevents children from locking themselves in, for example. It also makes it easier for you to quickly access a person in need of help.



DESCRIPTION	ART. NO.
Pitch 27.5 / 27.5 ; different keyings	BO 5206656
Pitch 31.5 / 31.5 ; different keyings	BO 5206624
Pitch 31.5 / 31.5 ; keyed alike	BO 5206625
Material	Brass

i incl. 3 keys

Knob cylinder



DESCRIPTION	ART. NO.
Pitch 27.5 / 27.5 ; different keyings	BO 5206657
Pitch 31.5 / 31.5 ; different keyings	BO 5206619
Pitch 31.5 / 31.5 ; keyed alike	BO 5206620
Material	Brass

i incl. 3 keys

Replacement latch for Studio Private Line glass door lock for 10-10.76 mm glass with 24 mm rebate depth

	ART. NO.
	BO 5206804
Material	Zinc die-cast



i When using ESG 10-10.76 mm with a rebate depth of 24 mm, the latch in the lock must be replaced. · Milled latch

Overtravel stop with floor bushing

Overtravel stay-put to hold the demand leaf in place on double-leaf glass doors



FINISH · GLASS THICKNESS	ART. NO.
Aluminium coloured anodised E4/C0 · 8 mm	BO 5206781
Aluminium coloured anodised E4/C0 · 10 mm	BO 5206783
Stainless steel effect anodised E4/C31 · 8 mm	BO 5206782
Stainless steel effect anodised E4/C31 · 10 mm	BO 5206855
powder coated matt black RAL 9005 · 8 mm	BO 5206784
powder coated matt black RAL 9005 · 10 mm	BO 5206785

i Overtravel stop with matt nickel-plated bottom bush - no glass processing required

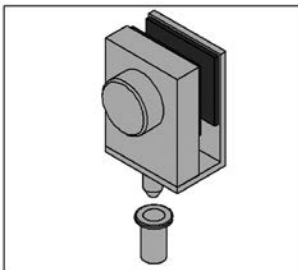
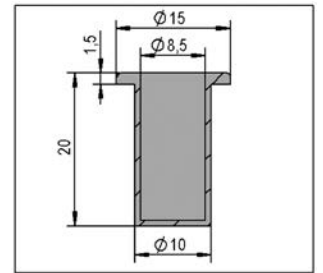
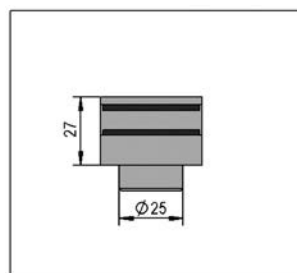
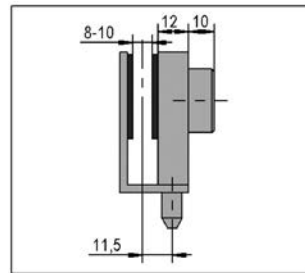
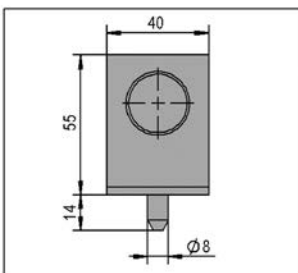

Lowering seals screed GS-A



i Ideal for retrospective sealing of smooth glass, metal, aluminium, wood and plastic doors · Seals can be shortened independently, please note the minimum length. · Incl. cover strip silver-coloured · Sound insulation 41 dB

LENGTH · CAN BE SHORTENED TO · FINISH	ART. NO.
708 mm - 583 mm - Aluminium colour anodised E6/EV1	BO 5220750
833 mm - 708 mm - Aluminium colour anodised E6/EV1	BO 5220751
958 mm - 833 mm - Aluminium colour anodised E6/EV1	BO 5220752
1083 mm - 958 mm - Aluminium colour anodised E6/EV1	BO 5220753
708 mm - 583 mm - stainless steel effect anodised E1/C31	BO 5220754
833 mm - 708 mm - stainless steel effect anodised E1/C31	BO 5220755
958 mm - 833 mm - stainless steel effect anodised E1/C31	BO 5220756
1083 mm - 958 mm - stainless steel effect anodised E1/C31	BO 5220757

Material

Aluminium

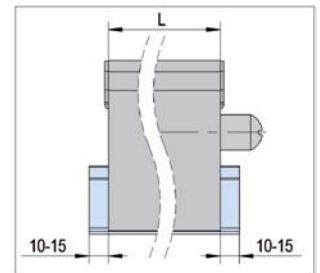
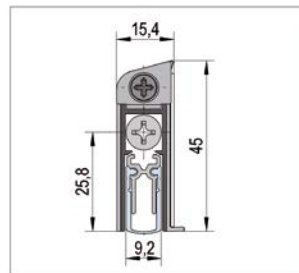

Drop-down seals Schall-Ex GS-8



i Ideal for sealing glass doors · seals can be shortened independently, please note the minimum length. Suitable for DIN-L and DIN-R doors · One-sided release · Sound insulation 41 dB

LENGTH · CAN BE SHORTENED TO	ART. NO.
958 mm - 833 mm	BO 5220758
1083 mm - 958 mm	BO 5220759

Material

Aluminium

Finish

powder coated matt
black RAL 9005

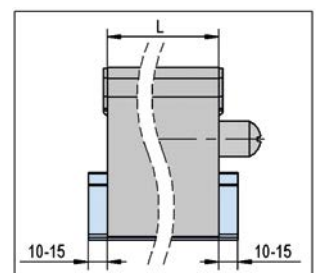
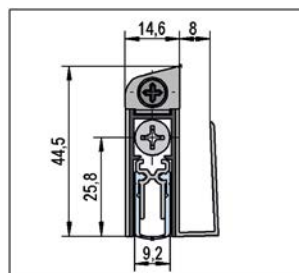

Drop-down seals Schall-Ex GS-10



LENGTH · CAN BE SHORTENED TO	ART. NO.
958 mm · 833 mm	BO 5220760
1083 mm · 958 mm	BO 5220761

Material	Aluminium
Finish	powder coated matt black RAL 9005

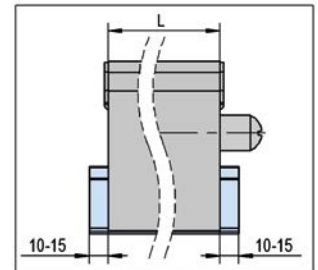
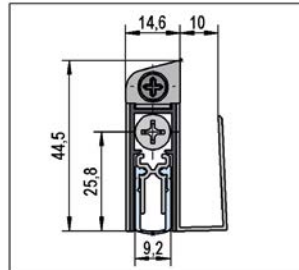

1 Ideal for sealing glass doors · seals can be shortened independently, please note the minimum length. · Suitable for DIN-L and DIN-R doors · One-sided release · Sound insulation 41 dB · For 10 - 10.76 mm glass

Bohle Duplocoll® double-sided adhesive tape

Duplocoll® is the ideal adhesive tape for sealing glass joints where transparency is important, such as in all-glass partitions, furniture construction or shower enclosures. The adhesive joints are almost invisible because the refractive index of the adhesive tape is almost identical to that of glass.



DESCRIPTION · WIDTH	ART. NO.
Glass thickness ESG 8 mm, VSG 8.76 mm · 5 mm	BO 5207936
Glass thickness ESG 10 mm, VSG 10.76 mm · 7 mm	BO 5207938
Glass thickness ESG 12 mm, VSG 12.76 mm · 9 mm	BO 5207935
Glass thickness VSG 17.52 mm · 14 mm	BO 5209630

Length	12 m
Finish	transparent

1 Significant time and cost savings compared to sealing with silicone · Adhesive-passive dry edge makes Duplocoll® insensitive to external influences · Antimicrobial, prevents the growth of microorganisms · Resistant to chemicals and plasticisers · Very good initial adhesion, permanently high final strength · Ageing and UV-resistant, economical, high-quality and design-friendly · Clean and very simple application process, especially with optional applicator (BO 5207939N) · For different materials such as wood, aluminium, plastic, ceramics or glass · Versatile benefits - Duplocoll® not only bonds, but also seals, damps, insulates and protects · Tolerances and tensions are optimally compensated · Joints are closed to create a sealed system · Also for rough surfaces: the viscoelastic adhesive film "flows" over the entire surface, even in roughness depths · Sound insulation-tested adhesive tape - Duplocoll® closes the adhesive joint between the glass panes so tightly that the sound insulation is demonstrably maintained. · Thickness 3 mm · Temperature resistance: -40°C - +150°C · When using Duplocoll® on laminated safety glass with acoustic PVB film, the suitability must be checked in advance. · A standard laminated safety glass with PVB film shows no interaction with Duplocoll® products!

We recommend panel clamps BO 650.20 as a working aid for sliding the glass panels together.

Bohle Duplocoll® applicator



DESCRIPTION	ART. NO.
Glass thickness ESG 8 - 10 mm	BO 5207939N
Glass thickness ESG 12 mm, VSG 10.76 - 12.76 mm	BO 5207946N

① Use our applicator for easy and precise application of Duplocoll® adhesive tapes to the glass edge. · for glass thicknesses 10 and 12 mm suitable extension inlay BO 5207948 in combination with applicator BO 5207939N · for glass thicknesses 8; 8.76 and 10 mm suitable extension inlay BO 5207947 in combination with applicator BO 5207946N · for glass thickness 17.52 mm suitable extension inlay BO 5207949 in combination with applicator BO 5207946N

Bohle Duplocoll® extension inlay for applicator



DESCRIPTION	ART. NO.
Accessories for BO 5207939N · Glass thickness ESG 10 - 12 mm	BO 5207948
Accessories for BO 5207946N · Glass thickness ESG 8 - 10 mm, VSG 8.76 mm	BO 5207947
Accessories for BO 5207946N · Glass thickness VSG 17.52 mm	BO 5207949

Veribor® plate tensioner for tensioning, opening, closing

Positioning large-area components easily and safely. Positioning large, heavy panels by hand and joining them exactly and flat is a difficult task. With the Veribor® panel clamp, the perfect position can be precisely determined and, if necessary, easily corrected without the entire panel structure slipping. - The Veribor® plate tensioner is the ideal tool for controlled and millimetre-accurate tensioning, opening and closing of large-surface, smooth plate material. For adjustment, the pump suction lifters with relaxed rubber discs are pressed firmly onto the surfaces to be suctioned. With just a few pumping movements, a vacuum is created with maximum vacuum and maximum horizontal clamping force of up to 1,200 N. The safety of the vacuum can be easily checked via a red marking ring on the pump plunger. In the event of a loss of vacuum, the vacuum can be re-established at any time without detaching the plate clamp from the substrate or it can be completely released by using the valve.



	ART. NO.
	BO 650.20
Torque	1200 Nm
Suction lifter material	Plastic
Surface geometry	plan
Suction disc	ø 214 mm
Fastening option	Plate clamp
Vacuum safety indicator	yes

i If necessary, the height difference of the panels can be compensated with the lateral eccentric lever.

Verifix® eccentric stop

Eccentrically arranged, flat plastic disc · Ø 70 mm · with integrated vacuum suction cup 55 mm Ø · turning the plastic disc creates a stop that is continuously adjustable up to 6 mm · Suitable for universal adjustment of panel-shaped materials · Especially for gluing in intermediate shelves or compartments in showcases · Can also be used individually and in pairs as a finely adjustable ruler stop

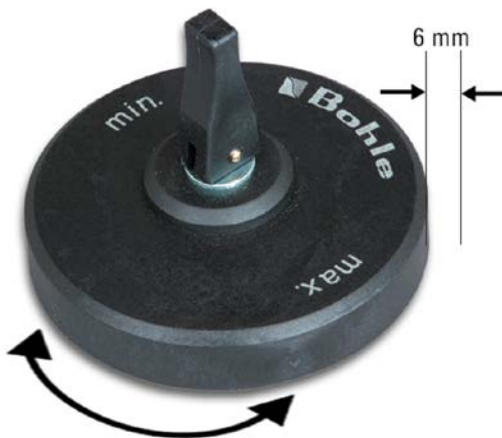

i Eccentric, flat plastic disc · Integrated vacuum cup · well suited for gluing in shelves or compartments in showcases · can also be used individually and in pairs as a finely adjustable ruler stop · suction discs Ø 55 mm · eccentric Ø 70 mm · adjustment range 6 mm

DESCRIPTION · FIXING TYPE	ART. NO.
Verifix® eccentric stop · Vacuum	BO 637.1
Spare rubber · Spare part	BO 637.5
Adjustment possibility	Height adjustment · Depth adjustment
Angle	90°



Euroclick spacer plate type 3 , 40 x 30 mm

Spacer plates are used in window, door, interior and drywall construction. They are used to compensate for unevenness and for quick alignment. The locking hook prevents slipping off the screw. The mounting aid makes it easy to position the spacer plate.



THICKNESS - COLOUR	ART. NO.
1 mm · white	BO 5133101
3 mm · red	BO 5133103
5 mm · green	BO 5133105
Material	Plastic
Length	40 mm
Width	30 mm

i Compensation/backing of profiles (e.g. FrameTec Select 2.0, MasterTrack® FT) for uneven walls · Bag of 100 pieces · With mounting aid · With locking hooks

Plastic blocks (100 in a bag)



THICKNESS - DESCRIPTION	ART. NO.
1 mm · colour white	BO 5122301
2 mm · colour red	BO 5122302
3 mm · colour green	BO 5122303
4 mm · colour yellow	BO 5122304
5 mm · colour blue	BO 5122305
6 mm · colour black	BO 5122306
Material	Plastic
Length	100 mm
Width	24 mm

i Tested, sealant-compatible material · universally applicable due to cross-ribbed surface and stable underside · the shape of the blocks guarantees a flush stop blocking at the inner edge of the glass rebate · Manufactured in accordance with the Technical Guidelines of the Glazier Trade No. 3 "Blocking of glazing units" · Load capacity per block max. 300 kg · Packaging unit 100 pcs.

Plastic blocks (100 in a bag)



i Tested, sealant-compatible material · universally applicable due to cross-ribbed surface and stable underside · the shape of the blocks guarantees a flush stop blocking at the inner edge of the glass rebate · Manufactured in accordance with the Technical Guidelines of the Glazier Trade No. 3 "Blocking of glazing units" · Load capacity per block max. 300 kg · Packaging unit 100 pcs.

THICKNESS - DESCRIPTION	ART. NO.
1 mm · colour white	BO 5122001
2 mm · colour red	BO 5122002
3 mm · colour green	BO 5122003
4 mm · colour yellow	BO 5122004
5 mm · colour blue	BO 5122005
6 mm · colour black	BO 5122006

Material	Plastic
Length	100 mm
Width	20 mm



SOUNDPROOFING FAQ

What is sound?

Sound generally describes mechanical vibrations of an elastic medium. These vibrations propagate in the form of sound waves in the air and in solid bodies.

How can sound be damped?

To dampen sound, the sound waves are opposed by a resistance. This resistance can be precisely determined by measurement in the laboratory.

Where and how is sound reduction measured?

The measurement is carried out by an approved test centre at a test stand. It consists of two adjoining rooms with a partition wall in which the component to be tested is installed. The edge transmission is suppressed. In the transmitter room, sound, the so-called pink noise, is generated in a certain frequency range. The incoming sound is recorded in the reception room in order to determine the sound insulation dimensions.

Where are the requirements for sound insulation defined?

The standard DIN 4109 "Sound insulation in buildings" defines the minimum requirements for sound insulation and the weighted sound reduction index R_w in "rooms requiring protection".

What does the sound reduction index R_w say?

The sound reduction index R_w is given in decibels (dB) and indicates by how many decibels the noise level of the tested element is reduced when measured in the test laboratory. Therefore, pay attention to which value is required in a tender.

What does the sound reduction index $R_{w,R}$ stand for ?

$R_{w,R}$ stands for the calculated value of the weighted sound dimension of a building component. The weighted sound reduction index R_w must be at least 5 dB above the values required for the intended use (for doors according to DIN 4109).
 $R_{w,R} = R_w - 5 \text{ dB}$

Which value is important for construction?

R'_w specifies the sound insulation requirement for the functional element in the building. "R-aphostrophe" means that the values include the sound transmission via the flanking components or secondary paths.

Is it to be expected that sounds (speech, music, noise, etc.) will no longer be perceived at all after installation?

No, because the partition walls can only reduce the noise level by a certain amount. The different frequencies must also be taken into account. High tones are subjectively perceived as louder than lower tones. At certain frequencies, a significant decrease in sound insulation is to be expected. The sound insulation curve, which is enclosed with a test certificate, can be helpful here.

TIPS & TRICKS FOR IMPROVING SOUND INSULATION

Sound is not only transmitted from room to room via the partition wall, but also via the ancillary sound paths, which have a great influence on the sound quality of an overall construction. Therefore, when planning the sound insulation, pay attention not only to the correct selection of the partition system, but also to the adjacent and flanking components (walls, ceilings, shafts, etc.) as well as the door leaf, rebate seal, glass structure, locking and joints. In order to achieve a satisfactory result in the end, careful planning and proper installation are required.

Frame

The gap between the door leaf and the circumferential frame is closed with a rebate seal (or stop seal). The seal should lie completely on the door leaf. Make sure that the door leaf is level.

Floor

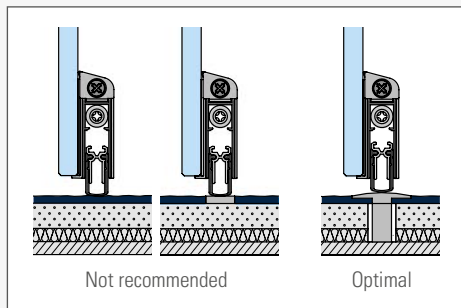

The air gap (usually 7 mm) between the top edge of the floor and the bottom edge of the door leaf is closed with a floor lowering seal. The rubber lip should lie completely against a flat, smooth surface when lowered. A Floor threshold is strongly recommended for carpeted floors. To avoid sound bridges, carpet should be interrupted in the area of the threshold. It is also important to shorten the rubber lip to the frame rebate dimension, otherwise gaps will appear to the left and right of the door.

Glass structure

The heavier the pane per unit area, the higher the sound insulation value generally is. At the same time, the more elastic the individual panes are, the higher their sound insulation value. Laminated glass panes with sound insulation film make use of this knowledge: The elastic connection of two individual panes combines a high pane mass with low bending stiffness.

Ceiling connection

If the ceiling is suspended, run the partition wall up to the raw ceiling. If this is not possible, provide an absorber bulkhead in the suspended ceiling.

Wall connection

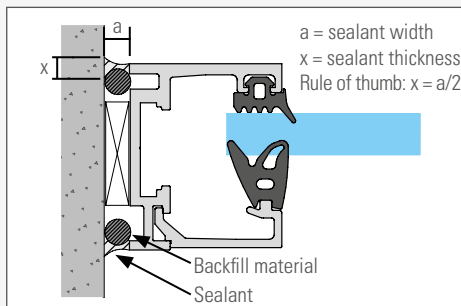

Separate the planking of the flanking assembly wall in the connection area. For joints between partition wall frames and adjoining components, we recommend filling the entire surface with a non-absorbent material (e.g. sealing cord) over the entire length of the profile. Subsequently, seal the joint with a permanently elastic sealant.

FrameTec Select 2.0 Planning Illustrations

From a door height > 2,200 mm we recommend the use of 3 hinges.

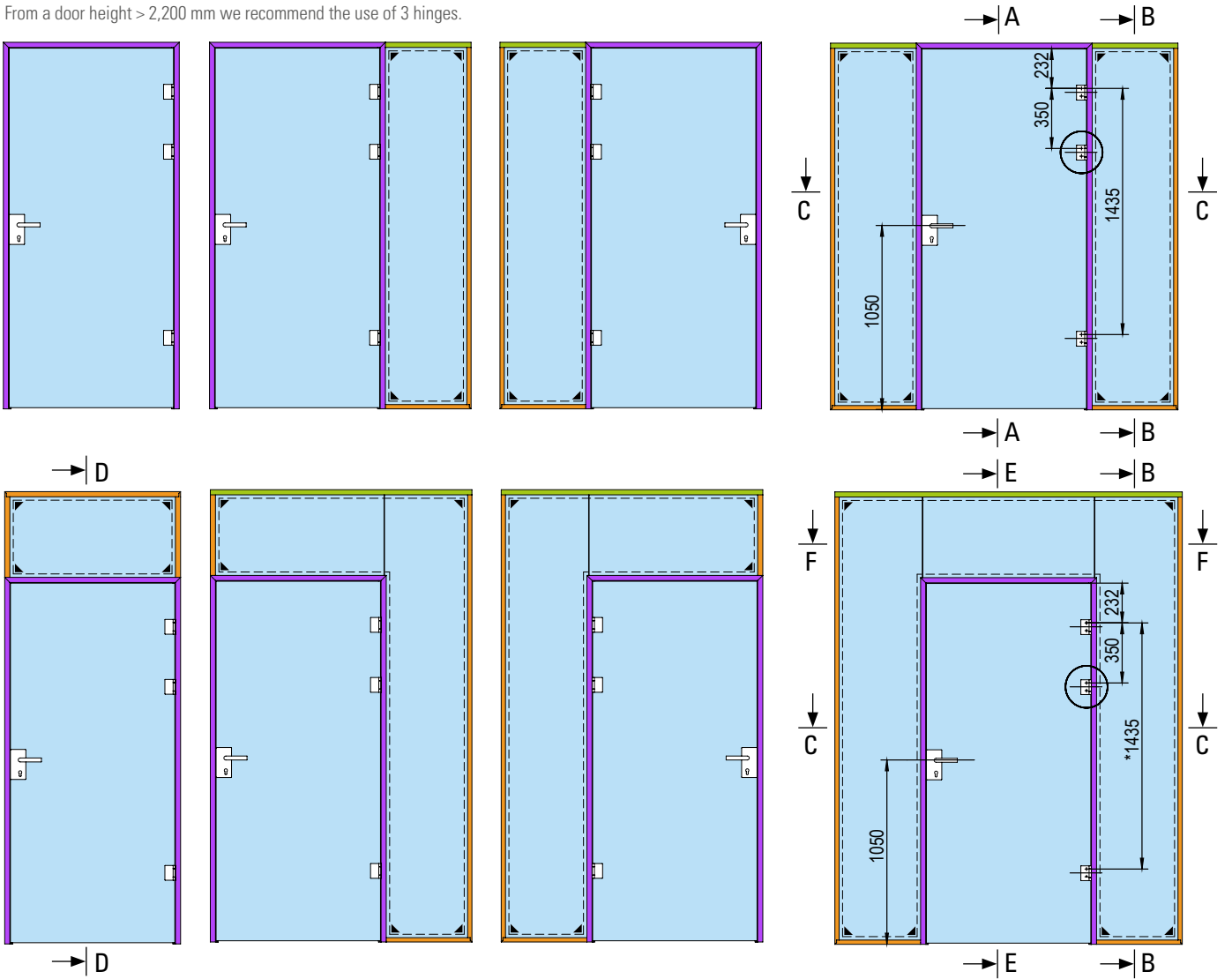

C - C

Recommendation: increase the gap to 6 mm when using door hinges BO 5206654 and BO 5206654B.

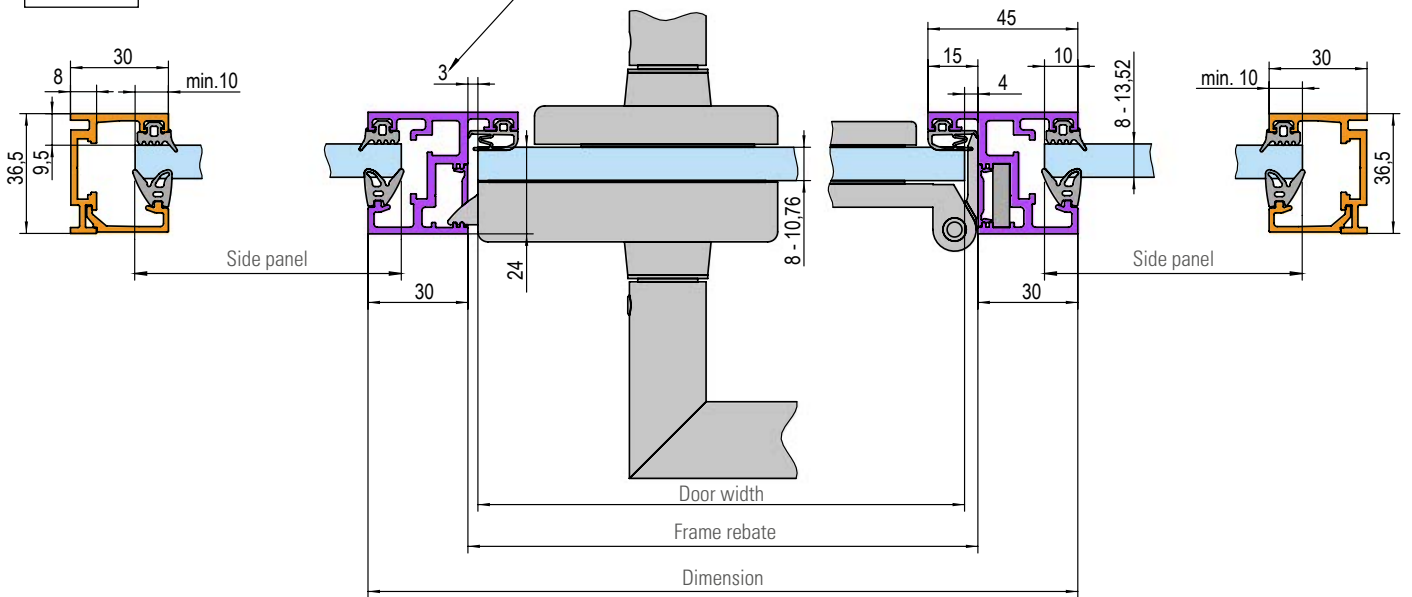

Glass door height	1910 - 2159 mm	2160 - 2284 mm	2285 - 2409 mm
*Distance 2	1435 mm	1685 mm	1810 mm

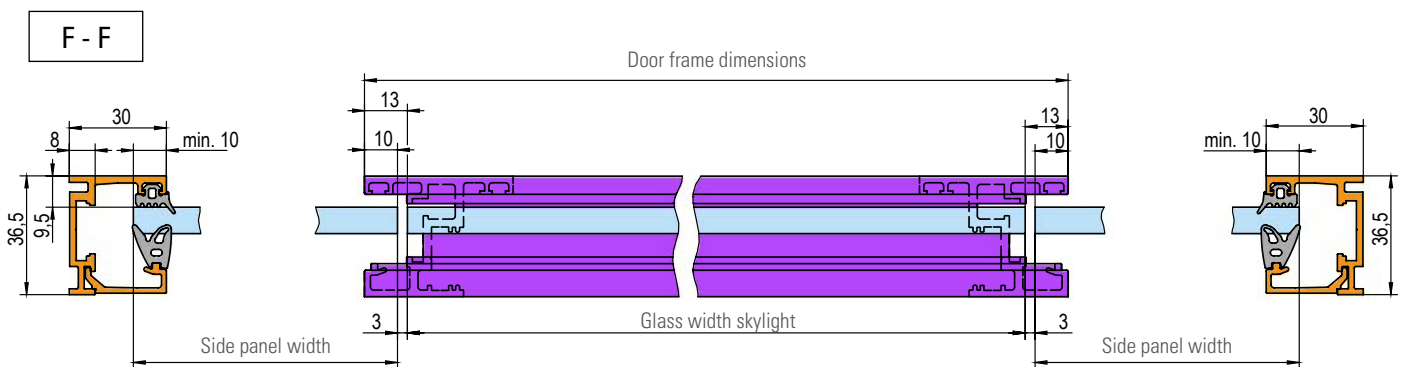
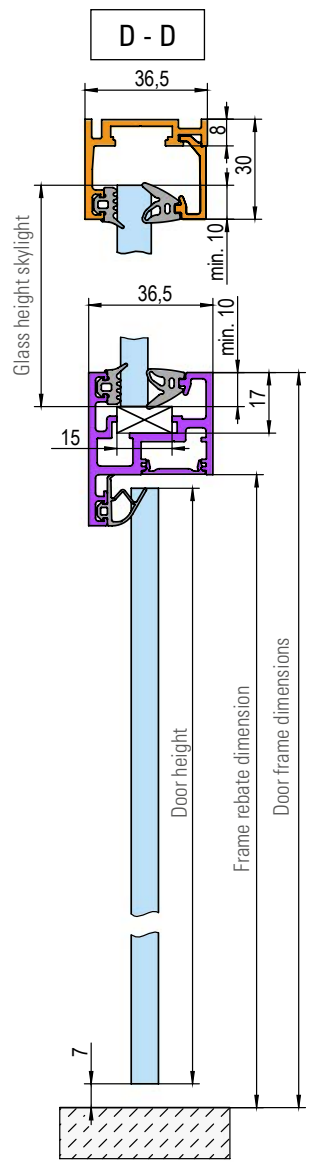
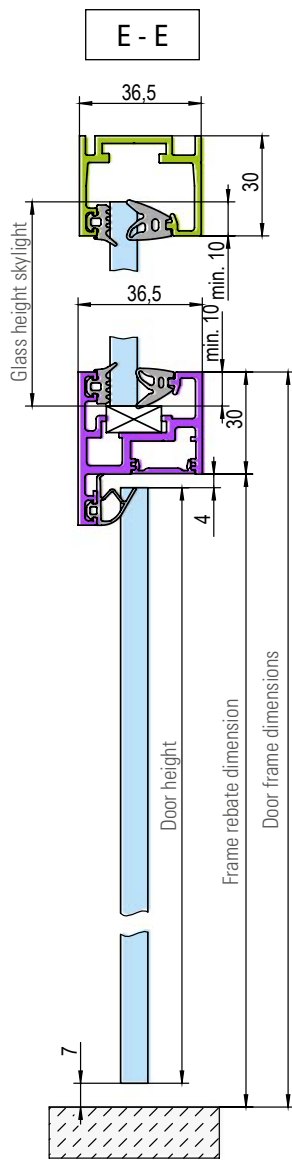
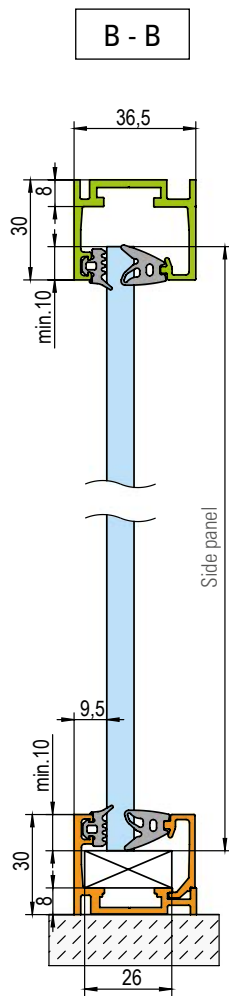
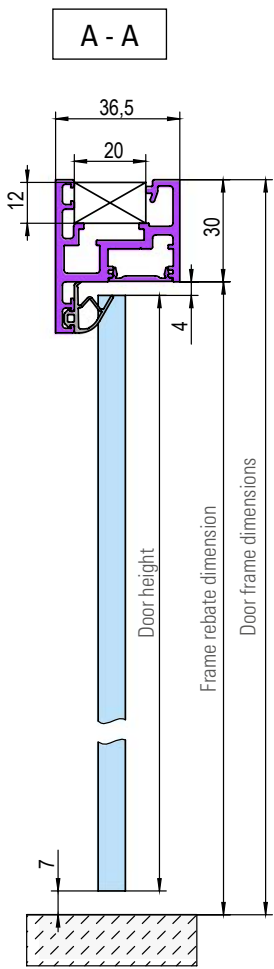

Frame profile

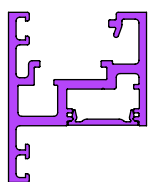

Glazing profile two-part

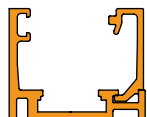

Glazing profile

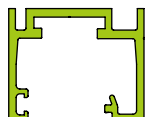

Base seal



Wedge seal



Stop seal



Corner connector



Installation of Glazing Profiles

Detail of base profile and glazing bead joint

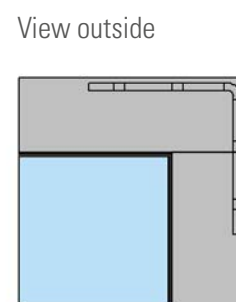
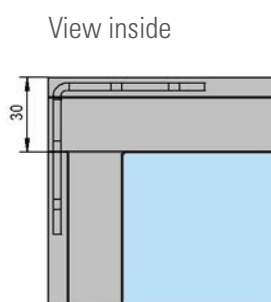
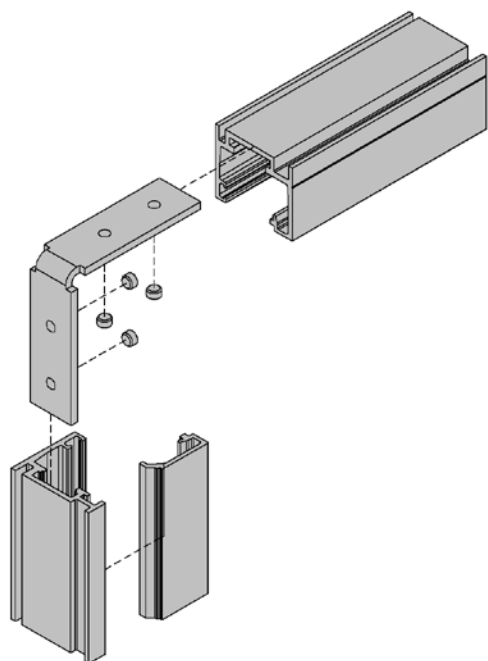

Detail of basic profile mitre and glazing bead blunt

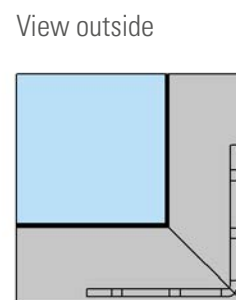
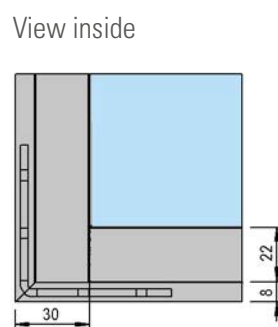
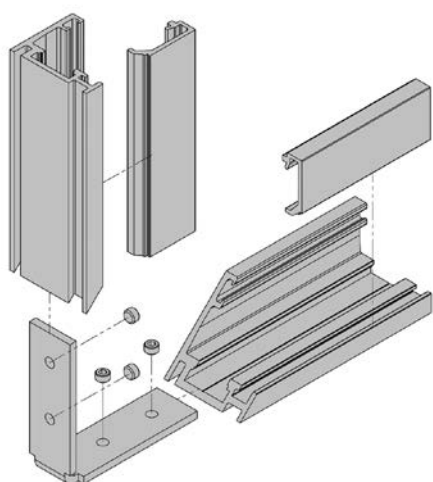

Detail of T-joint - basic profile inside / glazing bead outside

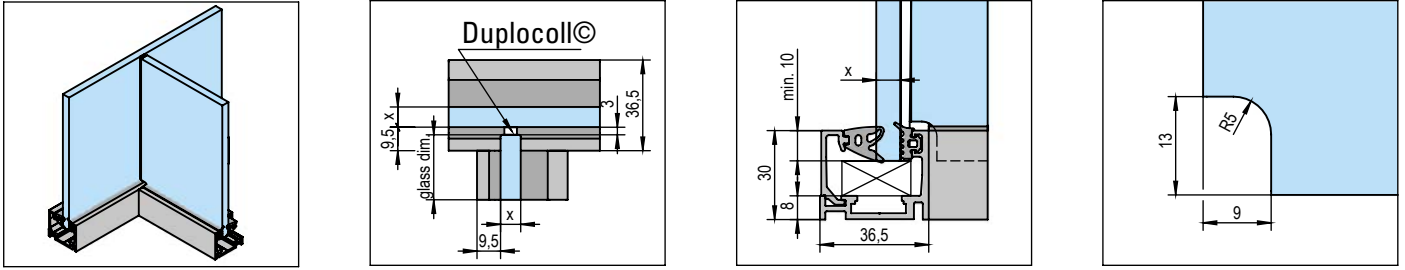

Detail of T-joint - basic profile outside / glazing bead inside

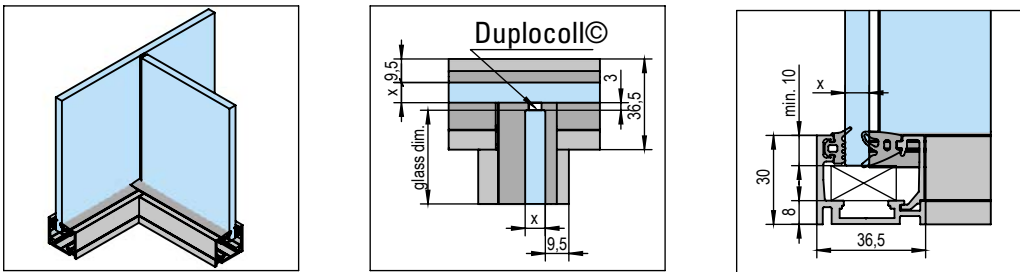

Detail of 90° corner - basic profile outside / glazing bead inside

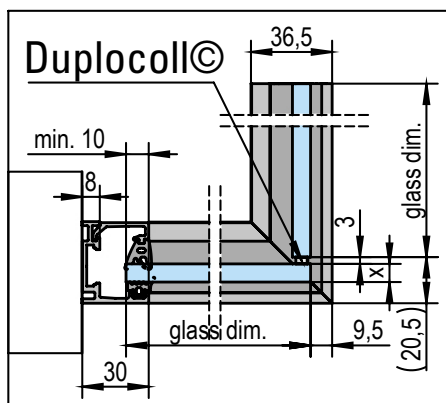



 Bohle

Bohle Ltd.
Fifth Avenue
Tameside Park
Dukinfield
Cheshire, SK16 4PP

T +44 161 3421100
F +44 161 3440111

info@bohle.ltd.uk
www.bohle.com