



Fittings for glass

Design Manual

Discover Bohle

The Bohle Group is one of Europe's leading manufacturers and wholesalers of tools, machinery and accessories for glass processing and glass finishing. The family business, founded in 1923, is now represented by over 300 employees at 14 locations in Germany and abroad. Divided into the product divisions Handling, Glass Cutting, Glass Bonding, Glazing, Tools, Machinery, Fittings and Surface Protection, the total product range is precisely tailored to the respective customer groups from trade, industry and retail.



The Bohle Online Shop

The Bohle Online Shop offers you our latest product range around the clock in a clearly structured and informative way.

Look forward to clearer arrangement, better performance and improved functionality: We will launch our brand new Online Shop in 2015.

www.bohle-group.com

Online from
2015



The Bohle Visitor Centre

In our Bohle visitor centre, located in the Haan headquarters, we present numerous products in a generous exhibition area. Whether it's fittings, machines, measuring devices or consumables: All products are available for trying and testing. Apart from a shopping area offering products to take away immediately with no waiting time, there is also a little museum giving an overview of Bohle's 90-year history.

Why not visit us – we look forward to welcoming you!



The Bohle Glass Academy

The Bohle Glass Academy offers you an extensive seminar programme on many glass processing topics. Learn new technologies or broaden your knowledge in well-known sectors.

Our Practical Seminars:

- UV Bonding
- Surface Bonding
- Manual Glass Cutting
- Sliding Door Installation

Each seminar includes:

- Seminar materials
- Use of practice materials and tools
- Fabrication of reference samples
- Customised troubleshooting
- Drinks, snacks and lunch
- Bohle Seminar Certificate

For current seminar dates, please visit our website www.bohle-group.com.

Symbols



Page Reference for
Planning Manual



Page Reference for
Design Manual

Discover the World of Fittings

The name "Bohle" represents glass hardware in all its aspects: In recent years our range of glass hardware has grown considerably. Bohle now offers the suitable hardware product for almost any application. We have divided our hardware products into different Worlds of Fittings in order to present them as clearly as possible:

- Fittings for Bathrooms
- Fittings for Interior Fit-Out
- Hardware for Furniture
- Hardware for Balustrades
- Hardware for Canopies

Thanks to a well thought-out outline of these main chapters, you quickly find the suitable product for your application. For further information about our products, please visit our Online Shop at www.bohle-group.com. If you have questions, do not hesitate to contact our friendly, expert sales team on 0800 616151.

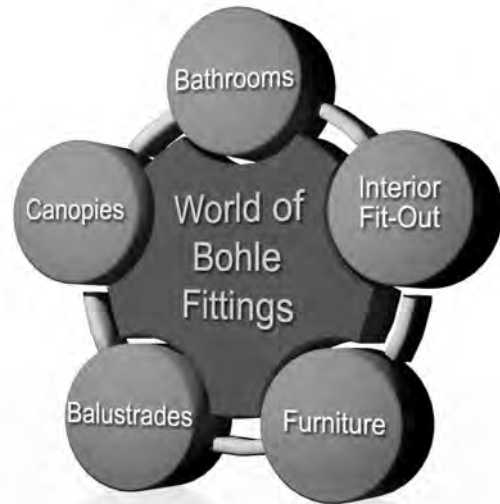

Planning and Design Manuals

This new edition of the Hardware Catalogue offers two practical work aids: a Design Manual and a Planning Manual.

The Planning Manual has more than 700 pages and contains relevant technical data and diagrams. It is meant to serve as a basis for quickly and easily calculating and implementing your projects and orders with Bohle products.

The Design Manual contains all essential product lines on approx. 160 pages, generously illustrated by numerous application images. This catalogue is perfect for choosing a suitable fitting together with your end customer, for example. User-friendly tables guide you to the right products; large images display the design and the application possibilities of the different products. In addition, intelligent cross-references in the Design Manual facilitate finding the corresponding products in the Planning Manual.

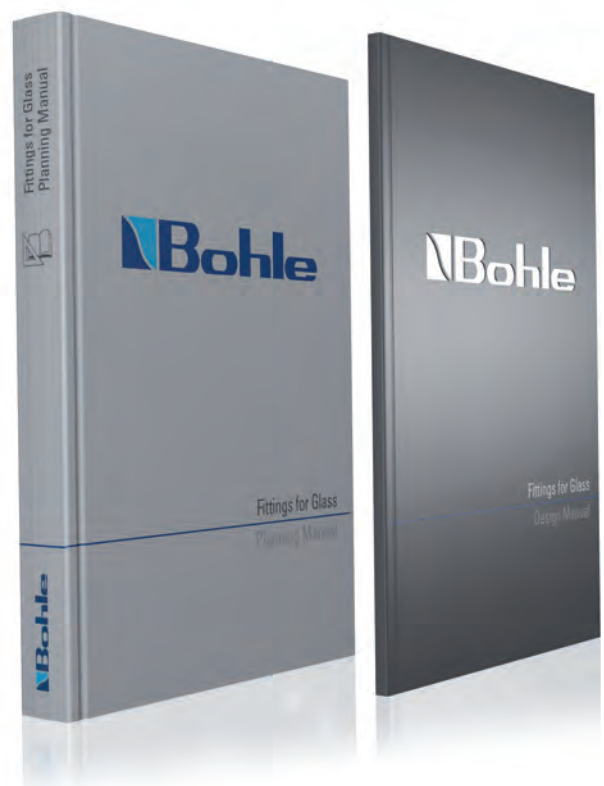

Contents

01

Shower Door Hinges · Sliding Door Systems for Showers · Accessories for Bathrooms · Reinforcement Bars · Door Knobs and Handles for Glass · Handles and Towel Holders for Showers · Profiles for Glass Partitions

02

Sliding Door Systems · Fittings for Pivot Doors · Accessories for Interior Fit-Out · Glass Door Handles · Glass Connectors and Point Fixings

03

Glass Door Handles · Glass Door Locks · Showcase Shelf Supports · Fittings for Sliding Glass Doors · UV Glass Door Hinges · Glass Door Locks for UV Bonding · Showcase Shelf Supports for UV Bonding

04

Railing Systems · Clamps

05

Canopy Systems · Fischer Fixing Technology





Fittings for Bathrooms



Interior Fittings



Hardware for Furniture



Hardware for Balustrades



Hardware for Canopies

Fittings for Bathrooms

Bohle proudly presents an extensive range of shower door hinges in the "Fittings for Bathrooms" chapter. The product portfolio has been compiled with selected quality manufacturers and complemented with a series of innovative in-house products.

Customised solutions for your individual project are available upon request.

In this chapter, you will also find all the products required for all-glass showers, mirror fixings and glass partitions.



Bohle







KL® meglä







EKU
Sliding Solutions



















Shower Door Hinges - At a Glance





ShowerTec® Premium	Romana	Milano	Milano Pur	Milano Original	Milano Premium
					
Swinging Shower Door Hinge	✓	✓	✓	✓	✓
Shower Door Hinge for one-side opening doors, continuous sealing strip					
Flush on the inner side					
Rise and fall mechanism					
Adjustment of zero position	✓	✓	✓	✓	✓
Drill holes in glass					
Glass cut-out	✓	✓	✓	✓	✓
Glass thickness tempered glass (mm)	8	8	8	8 / 10	8
Maximum door weight (kg)	40	40	40	50	40
Glass size (mm)	1000 x 2250	1000 x 2250	1000 x 2250	1000 x 2250 (8) 850 x 2250 (10)	1000 x 2250
Inspection according to DIN 14428	✓	✓	✓	✓	✓
 / 	13 / 12	17 / 14	26 / 16	30 / 18	33 / 20

ShowerTec® Select	Europe	Art	Easy	Bella	CULT
					
Swinging Shower Door Hinge	✓	✓	✓		
Shower Door Hinge for one-side opening doors, continuous sealing strip				✓	✓
Flush on the inner side					
Rise and fall mechanism					
Adjustment of zero position	✓		✓		✓
Drill holes in glass				✓	✓
Glass cut-out	✓	✓	✓		
Glass thickness tempered glass (mm)	8 / 10	6 / 8 / 10	6 / 8 / 10	6 / 8	8
Maximum door weight (kg)	40	35	38	40	40
Glass size (mm)	1000 x 2000	750 x 2000	900 x 2000	1000 x 2000	1000 x 2000
Inspection according to DIN 14428					
 / 	68 / 38	77 / 40	80 / 42	82 / 44	84 / 46

Atlantica	Fit	Quadrato	Wellness®	Wellness® Premium	Crossover Pur	Plan artist	Plan square
							
	✓					✓	
✓		✓	✓	✓	✓		✓
						✓	✓
					✓	✓	✓
✓	✓	✓		✓	✓		
✓		✓	✓	✓	✓		✓
	✓					✓	
8	8	8	8	8	8	8	8
40	40	40	40	40	35	38	38
1000 x 2250	1000 x 2250	1000 x 2250	1000 x 2250	1000 x 2250	900 x 2250	900 x 2100	900 x 2100
✓	✓	✓	✓	✓	✓	✓	✓
39 / 22	40 / 24	42 / 26	45 / 28	50 / 30	54 / 32	57 / 34	63 / 36

Wave	Granada	Marine	Barcelona Select	Bilbao Select	Plan cube	Plan curvum
						
✓	✓	✓	✓	✓		
					✓	✓
					✓	✓
✓	✓	✓	✓	✓		
✓	✓	✓	✓	✓	✓	✓
6 / 8	8 / 10	8 / 10	8 / 10 / 12	8 / 10 / 12	8	8
25	35	38	35	35	38	38
700 x 2000	790 x 2000	900 x 2000	700 x 2000	700 x 2000	900 x 2100	900 x 2100
57 / 48	91 / 50	95 / 52	99 / 54	101 / 56	72 / 58	74 / 60

ShowerTec® Basic	Barcelona	Bilbao
		
Swinging Shower Door Hinge	✓	✓
Shower Door Hinge for one-side opening doors, continuous sealing strip		
Flush on the inner side		
Rise and fall mechanism		
Adjustment of zero position		
Drill holes in glass		
Glass cut-out	✓	✓
Glass thickness tempered glass (mm)	8 / 10 / 12	8 / 10 / 12
Maximum door weight (kg)	35	35
Glass size (mm)	700 x 2000	700 x 2000
Inspection according to DIN 14428		
	109 / 62	110 / 64

Sliding Door Applications for Showers	Premium Slide SH	EKU-BANIO	EKU-BANIO light
			
Corner application (maximum mm)	1000 x 1000	1200 x 1200	900 x 900
Recess application (maximum mm)	1500	1500	1500
Corner application with glass sidelight	1500		
Drill holes in glass	✓		
Glass thickness tempered glass (mm)	8 / 10	8	8
Maximum door weight (kg)	60	40	40
	114 / 66	117 / 67	121 / 68



Romana Shower Door Hinges

For 8 mm glass, made of brass. The hinges have an arrest which can be activated or de-activated and set in any position and they also have an automatic return motion of $\pm 15^\circ$ to zero position. Outside the automatic return range, the hinges remain in any set position. Sold singly. Maximum door weight per pair of hinges: 40 kg · maximum door width: 1000 mm. All movable parts are maintenance-free. All Romana shower door hinges are swinging door hinges except for art. no. BO 5210222, BO 5210225.



90°



180°



135°



90°



135°



Shower Door Hinge Romana		chrome-plated	matt chrome-plated	stainless steel look	
	90° glass/wall, one side wall mounted	BO 5210212	BO 5210215		13
	90° glass/wall, both sides wall mounted	BO 5210202	BO 5210205		13
	180° glass/glass aligned	BO 5210232	BO 5210235		14
	90° glass/glass	BO 5210242	BO 5210245		15
	135° glass/glass	BO 5210252	BO 5210255		15
	180° glass/glass overlapping	BO 5210222	BO 5210225		14
Corner Clamp Romana					
	90° glass/wall	BO 5210262	BO 5210265		16
	90° glass/glass	BO 5210272	BO 5210275		16
	135° glass/glass		BO 5210285		17
Side Connector Romana					
	180° glass/wall	BO 5210277	BO 5210280		16

 Page Reference for Planning Manual

Milano Shower Door Hinges

For 8 mm glass, made of brass. Milano shower door hinges are swinging door hinges except for article numbers BK 06150xx, 06155xx. Thanks to a patented technology, the zero position can be infinitely adjusted. Maximum door weight per pair of hinges: 40 kg, maximum door width: 1000 mm.



90°



180°



135°



90°



135°



Shower Door Hinge Milano		chrome-plated	matt chrome-plated	stainless steel look	
	90° one side wall mounted	BK 0611031	BK 0611046	BK 0611055	17
	90° elongated hole for wall mounting	BK 0611231		BK 0611255	18
	90° both sides wall mounted	BK 0612031	BK 0612046	BK 0612055	18
	180° glass/glass aligned	BK 0613031	BK 0613046	BK 0613055	19
	90° glass/glass	BK 0614031	BK 0614046	BK 0614055	19
	180° glass/glass, overlapping opens inwards	BK 0615031	BK 0615046	BK 0615055	20
	180° glass/glass, overlapping opens outwards	BK 0615531	BK 0615546	BK 0615555	20
	135° glass/wall	BK 0616031	BK 0616046	BK 0616055	21
	135° glass/glass	BK 0617031	BK 0617046	BK 0617055	21
Corner Clamp Milano					
	90° elongated hole for wall mounting	BK 0680031		BK 0680055	22
	90° glass/wall	BK 0680131	BK 0680146	BK 0680155	22
	90° glass/glass	BK 0680331	BK 0680346	BK 0680355	22
	135° glass/wall	BK 0680531	BK 0680546	BK 0680555	23
	135° glass/glass	BK 0680731	BK 0680746	BK 0680755	23
	45° - 90° glass/wall for use with fixed constructions	BK 0681531		BK 0681555	25
	90° - 137° glass/wall for use with fixed constructions	BK 0681631		BK 0681655	25
	45° - 180° glass/glass for use with fixed constructions	BK 0681731		BK 0681755	26
Side Connector Milano					
	180° glass/wall	BK 0681131	BK 0681146	BK 0681155	24
	180° glass/glass	BK 0681331	BK 0681346	BK 0681355	24

Milano Pur Shower Door Hinges

This swinging door hinge follows in the technical footsteps of the popular Milano series. Its clear lines and distinctive shapes make a highlight of every bathroom. The zero position can be adjusted infinitely. Maximum door weight per pair of hinges: 40 kg, maximum door width: 1000 mm.



90°



180°



90°



90°



180°





Shower Door Hinge Milano Pur		chrome-plated	matt chrome-plated	stainless steel look	
	90° glass/wall, one side wall mounted	BK 0711031		BK 0711055	26
	90° glass/wall, with splash guard, for wall mounting	BK 0711131		BK 0711155	27
	90° glass/wall, elongated hole for wall mounting	BK 0711231		BK 0711255	27
	180° glass/glass aligned	BK 0713031		BK 0713055	28
	180° glass/glass, with splash guard	BK 0713231		BK 0713255	28
Corner Clamp Milano Pur					
	90° glass/wall, elongated hole for wall mounting	BK 0719031		BK 0719055	29
	90° glass/wall	BK 0719131		BK 0719155	29
	90° glass/glass	BK 0719331		BK 0719355	29
Side Connector Milano Pur					
	180° glass/glass	BK 0719431		BK 0719455	30

 Page Reference for Planning Manual

Milano Original Shower Door Hinge

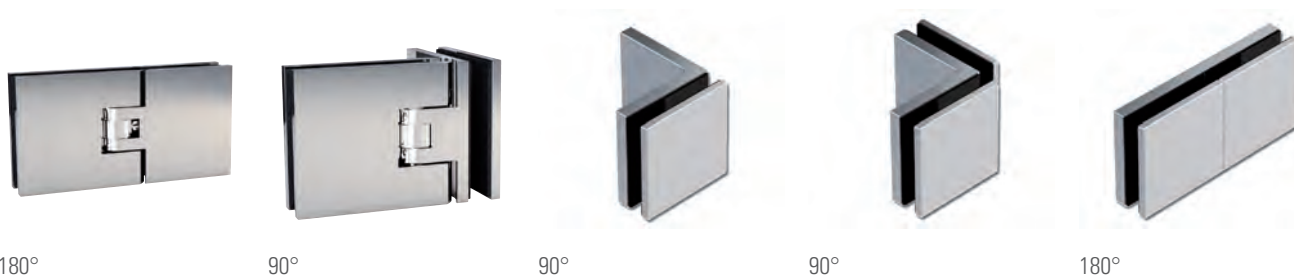
The Milano Original comes with the proven Milano Original technology, which remains impressive, despite its smaller size. This swinging door hinge also has covers on both sides so that hardly any screws can be seen. Its angular design lends a modern appearance to any bathroom. The zero position can be adjusted infinitely. Maximum door weight per pair of hinges: 50 kg, maximum door width: 1000 mm.



Shower Door Hinge Milano Original		chrome-plated	matt chrome-plated	stainless steel look	
	90° glass/wall, elongated hole for wall mounting	BK 0781231		BK 0781255	30
	180° glass/glass aligned	BK 0783031		BK 0783055	31
	90° glass/glass	BK 0784031			31
Corner Clamp Milano Original					
	90° glass/wall, elongated hole for wall mounting	BK 0749031		BK 0749055	31
	90° glass/glass	BK 0749331		BK 0749355	32
Side Connector Milano Original					
	180° glass/glass	BK 0749931		BK 0749955	32

 Page Reference for Planning Manual

Milano Premium Shower Door Hinge

The Milano Premium fittings exhibit the perfect blend of form and functionality. They excel due to their clear lines and distinctive shape. Their sophistication lies beneath the surface: The screws are completely concealed behind cover plates and provide a seamless exterior appearance. Small gap sizes, integrated gaskets and consequently the greatest tightness possible are to name just a few of the outstanding features of Milano Premium fittings. Also this system has an adjustable zero position. Maximum door weight per pair of hinges: 40 kg, maximum door width: 1000 mm.



90°



180°



90°



90°



90°



Shower Door Hinge Milano Premium		chrome-plated	matt chrome-plated	stainless steel look	
	90° glass/wall, elongated hole for wall mounting	BK 0741231			33
	180° glass/glass aligned	BK 0743031			33
	90° glass/glass	BK 0744031			34
Corner Clamp Milano Premium					
	90° glass/wall, elongated hole for wall mounting	BK 0749031		BK 0749055	34
	90° glass/glass	BK 0749331		BK 0749355	34



Page Reference for Planning Manual

Atlantica Shower Door Hinges

For 8 mm glass, made of brass. Atlantica shower door hinges are suitable for one side opening doors. Thanks to a patented technology, the zero position can be infinitely adjusted. Sealing strips can be passed through the hinge. Maximum door weight per pair of hinges: 40 kg, maximum door width: 1000 mm



90°



180°



135°



90°



135°



Shower Door Hinge Atlantica		chrome-plated	matt chrome-plated	stainless steel look	
	90° glass/wall, one side wall mounted	BK 0651031	BK 0651046		35
	90° glass/wall, one side wall mounted with elongated hole	BK 0651231			35
	90° glass/wall, both sides wall mounted	BK 0652031	BK 0652046		36
	180° / 135° glass/glass	BK 0653031	BK 0653046		36
	90° glass/glass	BK 0654031	BK 0654046		37
Corner Clamp Atlantica					
	90° glass/wall	BK 0686131	BK 0686146		37
	90° glass/wall, with elongated hole and cover plates for screw holes	BK 0686031			37
	90° glass/glass	BK 0686331	BK 0686346		38
	135° glass/wall	BK 0686531	BK 0686546		38
	135° glass/glass	BK 0686731	BK 0686746		38
Side Connector Atlantica					
	180° glass/wall	BK 0687131	BK 0687146		39
	180° glass/glass	BK 0687331	BK 0687346		39

 Page Reference for Planning Manual

Fit Shower Door Hinges

For 8 mm glass, made of brass. Fit shower door hinges are swinging door hinges. Thanks to a patented technology, the zero position can be infinitely adjusted. Maximum door weight per pair of hinges: 40 kg, maximum door width: 1000 mm.



90°



180°









90°



90°



Shower Door Hinge Fit		chrome-plated	matt chrome-plated	stainless steel look	
	90° glass/wall	BK 0721031			40
	180° glass/glass	BK 0723031			40
Corner Clamp Fit					
	90° glass/wall	BK 0728031			41
	90° glass/glass	BK 0728331			41

 Page Reference for Planning Manual

Quadrato Shower Door Hinges

For 8 mm glass, made of brass. Quadrato shower door hinges are suitable for one side opening doors. Thanks to a patented technology, the zero position can be infinitely adjusted. Sealing strips can be passed through the hinge. Maximum door weight per pair of hinges: 40 kg, maximum door width: 1000 mm.



180°



135°



90°











90°



45° - 180°



Shower Door Hinge Quadrato		chrome-plated	matt chrome-plated	stainless steel look	
	90° glass/wall	BK 0751031			42
	180° glass/glass	BK 0753031			42
	135° glass/glass	BK 0757031			43
Corner Clamp Quadrato					
	90° glass/wall	BK 0758131			43
	90° glass/glass	BK 0758331			43
	45° - 117° glass/wall for use with fixed constructions	BK 0759531			44
	45° - 180° glass/glass for use with fixed constructions	BK 0759731			44

 Page Reference for Planning Manual

Wellness[®]

Shower Door Hinges

Wellness[®] fittings offer superior comfort in a flexible shower system. Their use is as versatile as can be: in standard designs, frameless constructions or folding door systems. The door hinges swing freely. The latching function is achieved by magnetic sealing profiles. Sealing profiles can also be guided through the hinge itself (by-pass system). Maximum door weight per pair of hinges: 40 kg, maximum door width: 1000 mm



90°



180°



135°

















180°



90°



Shower Door Hinge Wellness®		chrome-plated	matt chrome-plated*	stainless steel look*	
	90° glass/wall, opens outwards	BK 0641031			45
	90° glass/wall, opens inwards	BK 0641131			45
	90° glass/wall, opens outwards	BK 0641531			46
	90° glass/wall, opens inwards	BK 0641631			46
	180° glass/glass, opens outwards	BK 0643031			46
	180° glass/glass, opens inwards	BK 0643131			47
	135° / 180° glass/glass, opens outwards	BK 0647031			47
Corner Clamp Wellness®					
	90° glass/wall, with elongated hole	BK 0648031			48
	90° glass/wall	BK 0648131			48
	90° glass/glass	BK 0648331			49
	135° glass/wall	BK 0648531			49
	135° glass/glass	BK 0648731			49
Side Connector Wellness®					
	180° glass/wall	BK 0647131			47
	180° glass/glass	BK 0647331			48

* matt chrome-plated and stainless steel look available on request

 Page Reference for Planning Manual

Wellness[®] Premium Shower Door Hinges

For 8 mm glass, made of brass. Wellness[®] Premium shower door hinges are suitable for one side opening doors. Thanks to a patented technology, the zero position can be infinitely adjusted. Sealing strips can be passed through the hinge. Maximum door weight per pair of hinges: 40 kg, maximum door width: 1000 mm



Shower Door Hinge Wellness® Premium		chrome-plated	matt chrome-plated	stainless steel look*	
	90° glass/wall, opens outwards DIN Direction right	BK 1641031			50
	90° glass/wall, opens inwards DIN Direction left	BK 1641131			50
	90° glass/wall, opens inwards DIN Direction right	BK 1641331			51
	90° glass/wall, opens outwards DIN Direction left	BK 1641231			51
	180° glass/glass, opens outwards DIN Direction right	BK 1643031	BK 1643046		52
	180° glass/glass, opens outwards DIN Direction left	BK 1643231	BK 1643246		52
	180° glass/glass, opens inwards DIN Direction right	BK 1643331	BK 1643346		53
	180° glass/glass, opens inwards DIN Direction left	BK 1643131	BK 1643146		53
	135° glass/glass, DIN right, opens outwards	BK 1647031			54
	135° glass/glass, DIN left, opens outwards	BK 1647231			54
Corner Clamp Wellness® Premium					
	90° glass/wall, with elongated hole	BK 0648031			48
	90° glass/wall	BK 0648131			48
	90° glass/glass	BK 0648331			49
	135° glass/wall	BK 0648531			49
	135° glass/glass	BK 0648731			49

*stainless steel look available on request

 Page Reference for Planning Manual

Crossover Pur Shower Door Hinges

This hinge with the proven rise and fall mechanism is suitable for one side opening doors - a smooth finish to the outside, a standard fixing plate to the inside. The zero position can be adjusted infinitely. Maximum door weight per pair of hinges: 35 kg, maximum door width: 900 mm



90°



90°



180°









90°



90°



Shower Door Hinge Crossover Pur		chrome-plated	matt chrome-plated	stainless steel look	
	90° glass/wall, stopper DIN right	BK 7001031			54
	90° glass/wall, stopper DIN left	BK 7001131			55
	180° glass/glass, stopper DIN right	BK 7003031			55
	180° glass/glass, stopper DIN left	BK 7003131			55
Corner Clamp Crossover Pur					
	90° glass/wall, elongated hole for wall mounting	BK 0728031			56
	90° glass/glass	BK 7009331			56

 Page Reference for Planning Manual

Plan artist Shower Door Hinges

Even double doors can be opened inwards and outwards with Plan artist. The perfect solution for barrier-free showers or sophisticated bathroom design in limited spaces. The Plan artist shower door hinges are flush on the inside and equipped with the unique rise and fall mechanism. Maximum door weight for 2 shower door hinges: 38 kg · maximum door width: 900 mm · packaging unit: 1 pair · maximum door height: 2100 mm



180°



135°



90°















90°



90°



Shower Door Hinge Set Plan artist		chrome-plated	matt chrome-plated	stainless steel look	
	90° glass/wall, stopper DIN left	BO 5215601	BO 5215602	BO 5215603	57
	90° glass/wall, stopper DIN right	BO 5215604	BO 5215605	BO 5215606	57
Shower Door Hinge Plan artist					
	180° glass/glass, stopper DIN left	BO 5215607	BO 5215608	BO 5215609	58
	180° glass/glass, stopper DIN right	BO 5215611	BO 5215612	BO 5215613	58
	135° glass/glass, stopper DIN left	BO 5215614	BO 5215615	BO 5215616	59
	135° glass/glass, stopper DIN right	BO 5215617	BO 5215618	BO 5215619	59
	90° glass/glass, stopper DIN left	BO 5215621	BO 5215622	BO 5215623	60
	90° glass/glass, stopper DIN right	BO 5215624	BO 5215625	BO 5215626	60
Corner Clamp Plan artist					
	90° glass/wall, mounting bracket inside	BO 5215631	BO 5215632	BO 5215633	61
	90° glass/wall, mounting bracket outside	BO 5215634	BO 5215635	BO 5215636	61
	90° glass/glass	BO 5215637	BO 5215638	BO 5215639	62
	135° glass/glass	BO 5215641	BO 5215642	BO 5215643	62

 Page Reference for Planning Manual

Plan square Shower Door Hinges

Plan square is equipped with the unique rise and fall mechanism making shower trays superfluous. Plan square is also flush mounted · maximum door weight for 2 shower door hinges: 38 kg · maximum door width: 900 mm · packaging unit: 1 piece · maximum door height: 2100 mm



180°



135°



90°









90°



135°



Shower Door Hinge Plan square		chrome-plated	matt chrome-plated	stainless steel look	
	90° glass/wall, stopper DIN left	BO 5215501	BO 5215502	BO 5215503	63
	90° glass/wall, stopper DIN right	BO 5215504	BO 5215505	BO 5215506	63
	180° glass/glass, stopper DIN left	BO 5215507	BO 5215508	BO 5215509	64
	180° glass/glass, stopper DIN right	BO 5215511	BO 5215512	BO 5215513	64
	135° glass/glass, stopper DIN left	BO 5215514	BO 5215515	BO 5215516	65
	135° glass/glass, stopper DIN right	BO 5215517	BO 5215518	BO 5215519	65
Corner Clamp Plan square					
	90° glass/wall, mounting bracket inside	BO 5215521	BO 5215522	BO 5215523	66
	90° glass/wall, mounting bracket outside	BO 5215524	BO 5215525	BO 5215526	66
	90° glass/glass	BO 5215531	BO 5215532	BO 5215533	67
	135° glass/glass	BO 5215534	BO 5215535	BO 5215536	67

 Page Reference for Planning Manual

Bohle Europe Shower Door Hinges

The Europe series of shower door hinges was developed by Bohle, taking both functionality and aesthetics into account. This product range has a timeless design which fits perfectly in modern bathrooms. The zero position is individually adjustable by +/- 5° and can easily be reset at any time. The Europe series is suitable for 8 or 10 mm glass and door weights up to 40 kg with a maximum door width: of 1000 mm (for 8 mm glass).



90°



180°



90°



90°

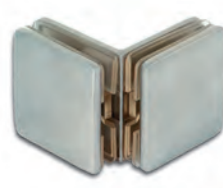

90°



Shower Door Hinge Europe		chrome-plated	matt chrome-plated	stainless steel look	
	90° glass/wall, one side wall mounted	BO 5400001	BO 5400002	BO 5400000	68
	90° glass/wall, both sides wall mounted	BO 5400011	BO 5400012	BO 5400010	69
	180° glass/glass aligned	BO 5400021	BO 5400022	BO 5400020	69
Corner Clamp Europe					
	90° glass/wall	BO 5400071	BO 5400072	BO 5400070	70
	90° glass/glass	BO 5400081	BO 5400082	BO 5400080	71
Connector Europe					
	90° glass/wall	BO 5400061	BO 5400062	BO 5400060	70

 Page Reference for Planning Manual

Art Shower Door Hinges

For 6, 8 or 10 mm glass. Made of brass. Art shower door hinges are swinging door hinges. Maximum door weight per pair of hinges: 35 kg, maximum door width: 750 mm



90°



180°



135°





90°



135°



Swinging Shower Door Hinge Art		chrome-plated	matt chrome-plated	stainless steel look	
	90° one side wall mounted with elongated hole	BK 8041031			77
	90° glass/wall, both sides wall mounted	BK 8042031			77
	180° glass/glass	BK 8043031			78
	135° glass/glass	BK 8047031			78
Corner Clamp Art					
	90° wall mounting with elongated hole	BK 8048131			78
	90° glass/glass	BK 8048331			79
	135° glass/glass	BK 8048731			79

 Page Reference for Planning Manual

Easy Shower Door Hinges

For 6, 8 or 10 mm glass. Made of brass. The shower door hinges are swinging door hinges with adjustable zero position. Maximum door weight per pair of hinges: 38 kg · maximum door width: 900 mm



90°



180°



135°



90°



90°



Swinging Shower Door Hinge Easy		chrome-plated	matt chrome-plated	stainless steel look	
	90° glass/wall	BK 8011031			80
	180° glass/glass	BK 8013031			80
	135° glass/glass	BK 8017031			81
Corner Clamp Easy					
	90° glass/wall	BK 8086131			81
	90° glass/glass	BK 8068331			81

 Page Reference for Planning Manual

Bella Shower Door Hinges

For 6 and 8 mm glass, made of brass. Bella shower door hinges are suitable for one side opening doors. Sealing strips can be passed through the hinge. Maximum door weight per pair of hinges: 40 kg · maximum door width: 1000 mm · no screws visible



90°



90°



180°









90°



90°



Shower Door Hinge Bella		chrome-plated	matt chrome-plated	stainless steel look	
	90° glass/wall, opens outwards	BK 8101231			82
	90° glass/wall, opens inwards	BK 8101331			82
	180° glass/glass	BK 8103031			83
Corner Clamp Bella					
	90° glass/wall	BK 8108031			83
	90° glass/glass	BK 8108331			83

 Page Reference for Planning Manual

CULT

Shower Door Hinges

CULT is a glass shower door hinge for one-side opening doors. This range of hinges is made from a base material of high quality brass, and has a zero position which can be infinitely adjusted. Maximum door weight per pair of hinges: 40 kg, maximum door width: 1000 mm



90°



180°



90°











90°



180°



Shower Door Hinge CULT		chrome-plated	matt chrome-plated	stainless steel look	
	90° glass/wall, elongated hole for wall mounting	BK 6051231			84
	90° glass/wall, both sides wall mounted	BK 6052031			84
	180° glass/glass	BK 6053031			85
Corner Clamp CULT					
	90° glass/wall, elongated hole for wall mounting	BK 6086031			85
	90° glass/wall	BK 6086131			85
	90° glass/glass	BK 6086331			86
Side Connector CULT					
	180° glass/wall	BK 6087131			86
	180° glass/glass	BK 6087331			86

 Page Reference for Planning Manual

Wave Shower Door Hinges

For 6 or 8 mm glass, made of diecast zinc. The hinges have an automatic return motion of $\sim \pm 15^\circ$ to zero position. Outside the automatic return range, the hinges remain in any set position. The zero position can be adjusted infinitely. Maximum door weight per pair of hinges: 25 kg · maximum door width: 700 mm



90°



180°



180°











135°



90°



Shower Door Hinge Wave		chrome-plated	matt chrome-plated	stainless steel look	
	90° glass/wall, one side wall mounted	BO 5330002	BO 5330005	BO 5330006	87
	90° glass/wall, both sides wall mounted	BO 5330012	BO 5330015	BO 5330016	87
	180° glass/glass aligned	BO 5330022	BO 5330025	BO 5330026	88
	180° glass/glass overlapping	BO 5330052	BO 5330055	BO 5330056	88
	90° glass/glass	BO 5330042	BO 5330045	BO 5330046	89
	135° glass/glass	BO 5330032	BO 5330035	BO 5330036	89
Connector Wave					
	90° glass/wall	BO 5213051	BO 5213052	BO 5213050	90

 Page Reference for Planning Manual

Bohle Granada Shower Door Hinges

Shower door hinges made of brass, suitable for 8 or 10 mm glass. The hinges have an automatic return motion of $\sim \pm 15^\circ$ to zero position. Outside this automatic return range, the hinges remain in any set position. Maximum door weight: 35 kg, maximum door width: 790 mm · with adjustable zero position



90°



180°



135°



90°



90°



Shower Door Hinge Granada		chrome-plated	matt chrome-plated	stainless steel look	
	90° glass/wall, one side wall mounted	BO 5214058	BO 5214059	BO 5214046	91
	90° glass/wall, both sides wall mounted	BO 5214050	BO 5214051	BO 5214045	91
	180° glass/glass	BO 5214052	BO 5214053	BO 5214047	92
	135° glass/glass	BO 5214054	BO 5214055	BO 5214048	92
	90° glass/glass	BO 5214056	BO 5214057	BO 5214049	93
Corner Clamp Granada					
	90° glass/glass	BO 5213622			93
	90° glass/wall	BO 5213116			94
Connector Granada					
	90° glass/wall	BO 5213612			93
	90° glass/wall	BO 5213606	BO 5213607	BO 5213605	94

 Page Reference for Planning Manual

Marine Shower Door Hinges

For 8 and 10 mm glass, made of diecast zinc. The hinges have an automatic return motion of $\sim \pm 15^\circ$ to zero position. Outside the automatic return range, the hinges remain in any set position. The zero position can be adjusted infinitely. Maximum door weight per pair of hinges: 38 kg · maximum door width: 900 mm



90°



180°



135°









90°



90°



Shower Door Hinge Marine		chrome-plated	matt chrome-plated	stainless steel look	
	90° glass/wall, one side wall mounted	BO 5320002	BO 5320005	BO 5320006	95
	90° glass/wall, both sides wall mounted	BO 5320012	BO 5320015	BO 5320016	95
	180° glass/glass aligned	BO 5320022	BO 5320025	BO 5320026	96
	90° glass/glass	BO 5320042	BO 5320045	BO 5320046	96
	135° glass/glass	BO 5320052	BO 5320055	BO 5320056	97
Corner Clamp Marine					
	90° glass/wall	BO 5213116			98
Connector Marine					
	90° glass/wall	BO 5213606	BO 5213607	BO 5213605	97



Page Reference for Planning Manual

Bohle Barcelona Select Shower Door Hinges

Shower door hinges made of brass, suitable for 8, 10 or 12 mm glass. The hinges have an automatic return motion of $\sim \pm 15^\circ$ to zero position. Outside this automatic return range, the hinges remain in any set position. Maximum door weight: 35 kg · maximum door width: 700 mm. The zero position is adjustable.



90°



180°



135°



90°



90°



Shower Door Hinge Barcelona Select		chrome-plated	matt chrome-plated	stainless steel look	
	90° (adjustable) one side wall mounted	BO 5219110		BO 5219111	99
	90° (adjustable) both sides wall mounted	BO 5219114		BO 5219115	99
	90° glass/wall, divided mounting plate, both sides wall mounted	BO 5219130		BO 5219131	100
	180° (adjustable) glass/glass	BO 5219118		BO 5219119	100
	135° (adjustable) glass/glass	BO 5219122		BO 5219123	100
	90° (adjustable) glass/glass	BO 5219126		BO 5219127	101
Corner Clamp Barcelona Select					
	90° glass/wall	BO 5200095	BO 5200197		109
	90° glass/glass	BO 5200097	BO 5200099		107
	90° glass/wall	BO 5219080		BO 5219081	109
	90° glass/glass	BO 5219060		BO 5219061	108
	135° glass/glass	BO 5219070		BO 5219071	108

 Page Reference for Planning Manual

Bohle Bilbao Select Shower Door Hinges

Shower door hinges made of brass, suitable for 8, 10 or 12 mm glass. The hinges have an automatic return motion of $\sim \pm 15^\circ$ to zero position. Outside this automatic return range, the hinges remain in any set position. Maximum door weight: 35 kg, maximum door width: 700 mm. The zero position is adjustable.



90°



180°



135°







90°



90°



Shower Door Hinge Bilbao Select		chrome-plated	matt chrome-plated	stainless steel look	
	90° (adjustable) one side wall mounted	BO 5211546		BO 5211547	101
	90° (adjustable) both sides wall mounted	BO 5211516		BO 5211517	102
	180° (adjustable) glass/glass	BO 5211716		BO 5211717	102
	135° (adjustable) glass/glass	BO 5211906		BO 5211907	102
	90° (adjustable) glass/glass	BO 5211806		BO 5211807	103
	90° glass/wall, small mounting plate, both sides wall mounted	BO 5211606		BO 5211607	103
Corner Clamp Bilbao Select					
	90° glass/glass	BO 5213150		BO 5213151	103
	90° glass/wall	BO 5213140		BO 5213141	104
	135° glass/glass	BO 5213170		BO 5213171	104
Side Connector Bilbao Select					
	180° glass/glass	BO 5213160		BO 5213161	104

 Page Reference for Planning Manual

Plan cube Shower Door Hinges

On the inner side of the glass, Plan cube and Plan curvum hinges are set flush to the glass - a sophisticated hinge alternative for demanding projects. Here first class design goes together with practicality: After having a shower, cleaning the glass is done in no time. No edges, no corners - just a flat surface · maximum door weight when using 2 shower door hinges: 38 kg · maximum door width: 900 mm · packaging unit: 1 piece · maximum door height: 2100 mm



180°

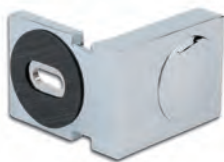

90°



90°









90°



135°



Shower Door Hinge Plan cube		chrome-plated	matt chrome-plated	stainless steel look	
	90° glass/wall	BO 5215571	BO 5215572	BO 5215573	72
	180° glass/glass	BO 5215574	BO 5215575	BO 5215576	72
Corner Clamp Plan cube					
	90° glass/wall, inwards	BO 5215581	BO 5215582	BO 5215583	73
	90° glass/wall, outwards	BO 5215584	BO 5215585	BO 5215586	73
	90° glass/glass	BO 5215587	BO 5215588	BO 5215589	73
	135° glass/glass	BO 5215591	BO 5215592	BO 5215593	74

 Page Reference for Planning Manual

Plan curvum Shower Door Hinges

On the inner side of the glass, Plan cube and Plan curvum hinges are set flush to the glass - a sophisticated hinge alternative for demanding projects. Here first class design goes together with practicality: After having a shower, cleaning the glass is done in no time. No edges, no corners - just a flat surface · maximum door weight when using 2 shower door hinges: 38 kg · maximum door width: 900 mm · packaging unit: 1 piece · maximum door height: 2100 mm



180°

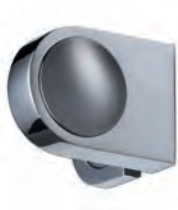

90°



90°











90°



135°



Shower Door Hinge Plan curvum		chrome-plated	matt chrome-plated	stainless steel look	
	90° glass/wall	BO 5215541	BO 5215542	BO 5215543	74
	180° / 135° glass/glass	BO 5215544	BO 5215545	BO 5215546	75
Corner Clamp Plan curvum					
	90° glass/wall, inwards	BO 5215551	BO 5215552	BO 5215553	75
	90° glass/wall, outwards	BO 5215554	BO 5215555	BO 5215556	75
	90° glass/glass	BO 5215557	BO 5215558	BO 5215559	76
	135° glass/glass	BO 5215561	BO 5215562	BO 5215563	76

 Page Reference for Planning Manual

Bohle Barcelona Shower Door Hinges

Shower door hinges made of brass, suitable for 8, 10 or 12 mm glass. The hinges have an automatic return motion of $\sim \pm 15^\circ$ to zero position. Outside this automatic return range, the hinges remain in any set position. Maximum door weight: 35 kg, maximum door width: 700 mm



90°



180°



135°

















90°



90°



Shower Door Hinge Barcelona		chrome-plated	matt chrome-plated	stainless steel look	
	90° glass/wall, one side wall mounted	BO 5218110		BO 5218111	105
	90° glass/wall, both sides wall mounted	BO 5219010		BO 5219011	105
	180° glass/glass	BO 5219210		BO 5219211	106
	90° glass/glass	BO 5219310		BO 5219311	106
	135° glass/glass	BO 5219410		BO 5219411	106
Corner Clamp Barcelona					
	90° glass/wall	BO 5200095	BO 5200197		109
	90° glass/glass	BO 5200097	BO 5200099		107
	90° glass/wall	BO 5219080		BO 5219081	109
	90° glass/glass	BO 5219060		BO 5219061	108
	135° glass/glass	BO 5219070		BO 5219071	108
Side Connector Barcelona					
	180° glass/glass	BO 5219090		BO 5219091	108
Connector Barcelona					
	90° glass/wall	BO 5219050		BO 5219051	107
	90° glass/wall	BO 5219040		BO 5219041	107

 Page Reference for Planning Manual

Bohle Bilbao Shower Door Hinges

Shower door hinges made of brass, suitable for 8, 10 or 12 mm glass. The hinges have an automatic return motion of $\sim \pm 15^\circ$ to zero position. Outside this automatic return range, the hinges remain in any set position. Maximum door weight: 35 kg, maximum door width: 700 mm



90°



180°



135°



90°

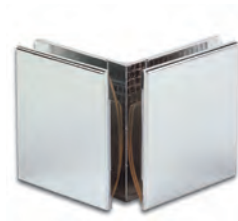

90°



Shower Door Hinge Bilbao		chrome-plated	matt chrome-plated	stainless steel look	
	90° glass/wall, one side wall mounted	BO 5211549		BO 5211550	110
	90° glass/wall, large mounting plate, both sides wall mounted	BO 5218010		BO 5218011	110
	180° glass/glass	BO 5218210		BO 5218211	111
	90° glass/glass	BO 5218330		BO 5218331	111
	135° glass/glass	BO 5218410		BO 5218411	111
Corner Clamp Bilbao					
	90° glass/glass	BO 5213130		BO 5213131	112
	90° glass/wall	BO 5213120		BO 5213121	113
Connector Bilbao					
	90° glass/wall	BO 5218420		BO 5218421	112
	90° glass/wall	BO 5218430		BO 5218431	112

 Page Reference for Planning Manual

Premium Slide SH Sliding Door System

The Premium Slide SH sliding door fittings for all-glass showers are made of high quality stainless steel and stand out due to their unobtrusive elegance. For domestic or commercial interiors. Bohle offer the following versions as a standard: corner application - double doors, recess application - single door and corner application - single door with sidelight.



Up to 60 kg



8/10 mm
tempered glass



Stainless steel
matt



Recess application
single door



Corner application
single door with sidelight



Corner application
double doors



EKU-BANIO

Sliding Door System

Modern bathrooms are nothing less than an oasis of well-being and a place for relaxing and resting. The use of finishes and high-quality materials are exceptionally important when it comes to meeting the requirements of functionality and design. EKU-BANIO fully lives up to this trend. The innovative sliding door technology leaves plenty of space for creativity and the clean aluminium lines emphasize the timeless elegance of the shower cubicle. EKU-BANIO is the sliding solution for high-quality all-glass shower cubicles.



Up to 40 kg



8 mm
tempered glass



Anodised



Recess application
single door



Corner application
double doors



Chrome-plated



EKU-BANIO light Sliding Door System

Modern bathrooms are nothing less than an oasis of well-being and a place for relaxing and resting. The use of finishes and high-quality materials are exceptionally important when it comes to meeting the requirements of functionality and design. EKU-BANIO light fully lives up to this trend. The innovative sliding door technology leaves plenty of space for creativity and the clean aluminium lines emphasize the timeless elegance of the shower cubicle. EKU-BANIO light is the sliding solution for high-quality all-glass shower cubicles.



Up to 40 kg



8 mm
tempered glass



Anodised



Recess application



Corner application
single door



Corner application
double doors



Accessories for Bathrooms

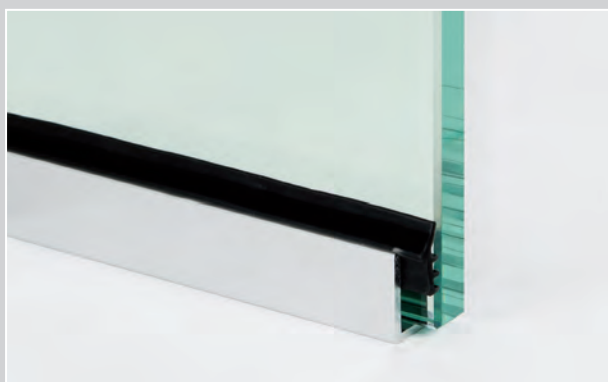

Bohle Premium round Reinforcement Bars

Well thought-out creation and design are the central focus of architecture. With its Premium products Bohle has succeeded in combining timeless elegance, aesthetics and freedom of movement with a blend of high-quality materials. The Premium round reinforcement bars have been specially designed for highly-frequented and barrier-free areas while maintaining their unobtrusive appearance. Made of polished stainless steel, the support bars fit harmoniously into any bathroom setting.



Bohle Premium square Reinforcement Bars

Less is more. Premium square achieves a perfect ratio of proportion, detail and material. Visible but unobtrusive. Premium square reinforcement bars captivate due to their clean straight lines. Minimalistic accentuation emphasises the features of modern bathroom landscapes. The brass support bars can easily be trimmed to size.



Bohle Basic round Reinforcement Bars

Easy to mount because reinforcement bars can be trimmed to any desired length. No cut-outs or bore holes in the glass required. Glass holders are infinitely adjustable.

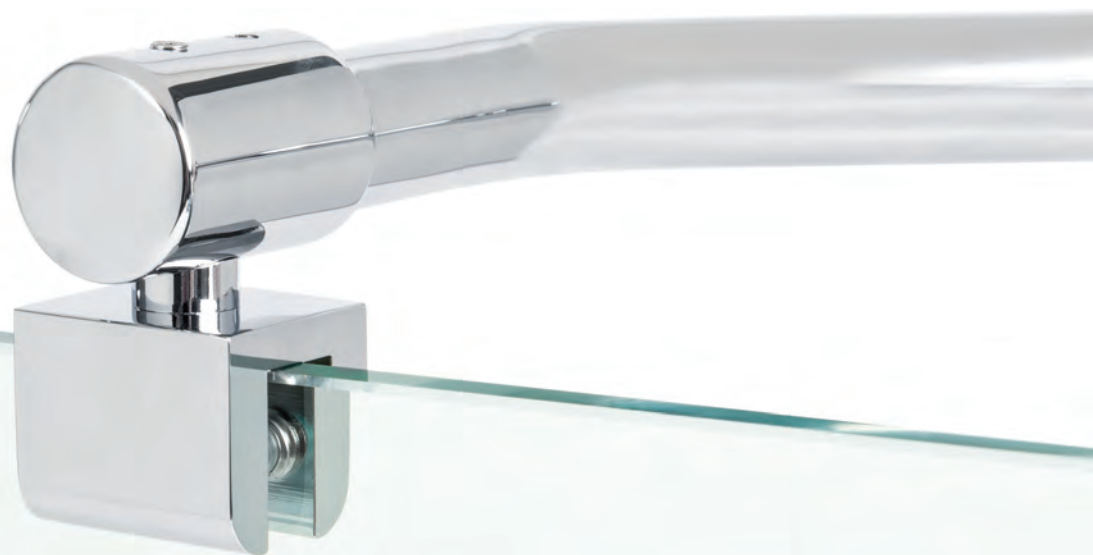





Bohle Basic square Reinforcement Bars





Timelessly modern. With Basic square, Bohle has achieved the perfect mix of form and function. The wide array of models enables almost any kind of customised construction project. Available in mirror polished and matt brushed stainless steel.



Door Knobs and Handles for Glass - At a G

Door Knobs for Glass				
Art. no.	BO 5213725/26	BO 5213705 - 10	BO 5213716/15	BO 5213722
Stainless steel 1.304				
Brass	✓	✓	✓	✓
Aluminium		✓		
Glass				
Glass thickness (mm)	6 - 10	6 - 10	6 - 10	6 - 10
Drill hole (mm)	10	10	10	10
	162	162	162	163





Door Knobs for Glass				
Art. no.	BO 5213771	BO 5206704	BK 0503031/55	BO 5206711-13
Stainless steel 1.304				
Brass	✓		✓	✓
Aluminium		✓		
Glass				
Glass thickness (mm)	4 - 8	6 - 10	8 - 10	6 - 12
Drill hole (mm)	8	12	12	10
	165	165	166	166

Door Handles for Glass				
Art. no.	BO 5113720+, BO 5113738+	BO 5212510-15	BO 5212520-25	BO 5212505-07
Stainless steel 1.304	✓	✓	✓	✓
Brass				
Aluminium				
Glass				
Glass thickness (mm)		4 - 12	4 - 12	6 - 10
Drill hole (mm)		10	10	10
Self-adhesive	✓			
	167	167	168	168

lance

					
BO 5213781	BO 5206702-03 / BO 5206802	BO 5213700-02	BK 0501331	BK 0501531	BO 5213750-52
	✓		✓	✓	✓
✓	✓	✓			
6 - 10	6 - 8	6 - 10	6 - 12	6 - 12	6 - 10
12	12	16	14	14	12
163	163	163	164	164	165

	
BO 5206714-16	BO 5206717-19
✓	✓
6 - 12	6 - 12
10	10
166	167



					
BO 5213849	BO 5215023	BO 5215033-36	BO 5215024	BO 5215025	BO 5215026
✓	✓	✓	✓	✓	✓
6 - 8	6 - 12	6 - 12	6 - 12	6 - 12	6 - 12
14	12	12	14	12	14
168	169	169	169	170	170

Handles and Towel Holders for Showers

The large variety of knobs, handles and towel holders helps individualise your shower cubicle to your personal bathroom concept. Great value is attached to the choice of different materials, finishes, applications and shapes available.

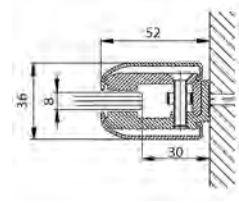
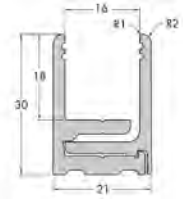
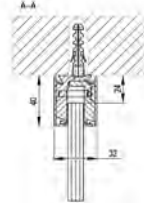
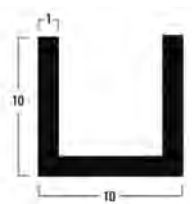

Profiles for Glass Partitions

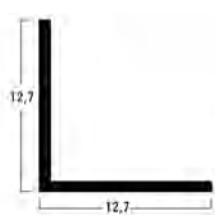
Clamp-on Profile	Clamp-on Frame Profile	Wall Connecting Profile
		
U-Profile	H-Bar	L-Profile
		



Interior Fittings

In the "Interior Fittings" division Bohle offers a diverse and highly specialised product range, including products from selected quality manufacturers and innovative in-house products. In this chapter you will find suitable sliding and hinged door systems for almost any situation. Door closing mechanisms and fittings for all-glass systems complete the list.

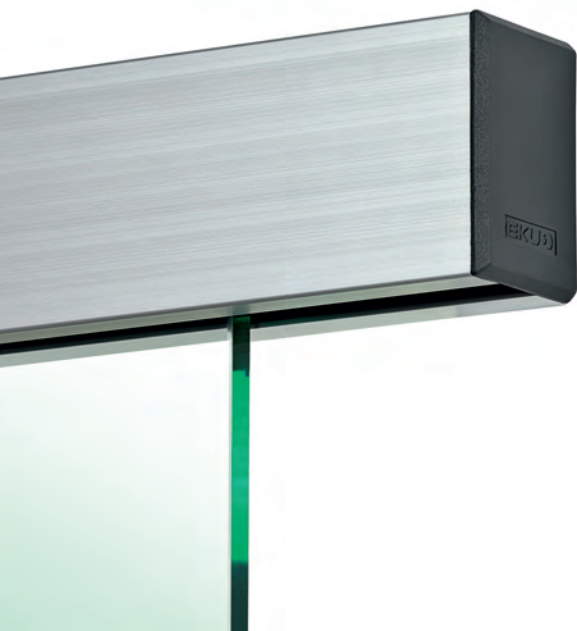

 **Bohle**

 **vitris**

 **Hawa** SWISS

 **KL® megl**

 **EKU**
Sliding Solutions

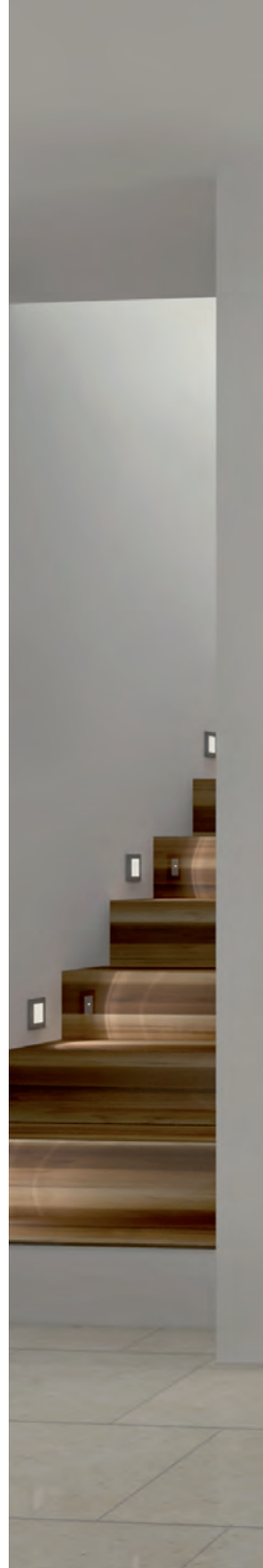

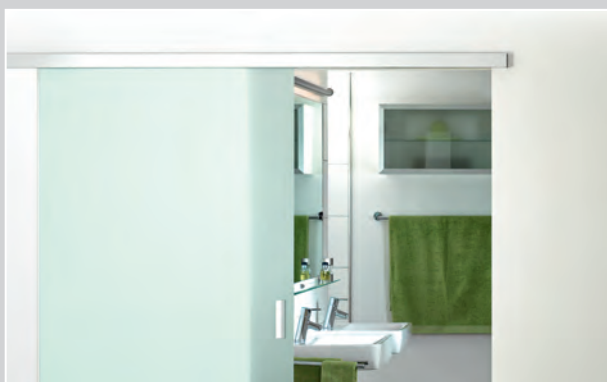

Sliding Door Systems - At a Glance

	Bohle SlideTec optima 60	Bohle SlideTec optima 150	Bohle SlideTec optima modul 80	Bohle SlideTec Premium	Bohle SlideTec	Bohle SlideTec Premium Floor	
							
Ceiling Mounting	✓	✓	✓			✓	
Wall Mounting	✓	✓	✓	✓	✓	✓	
Clamping technology (no drill holes in the glass required)	✓	✓	✓				
With patch suspension				✓	✓	✓	
Max. weight per sliding door (kg)	60	150	80	150	100	150	
Tempered glass (mm)	8/10	8/10/12	8/ 10	8/10/12	10/12	10/12	
Laminated safety glass (mm)	8.76 - 10.76	8.76 - 12.76					
Single door	✓	✓	✓	✓	✓	✓	
Double doors	✓	✓	○	○	○	✓	
Anodised aluminium EV1	✓	✓	✓				
Stainless steel				✓	✓	✓	
Stainless steel look	✓	✓	✓				
Profile height (mm)	57	70	93.3				
Fixed sidelight possible	✓	✓	○	✓	✓	✓	
Damping mechanism possible	✓	✓	✓				
Protection against draughts, noise, cold and odours	○	○	○				
 / 	211 / 84	225 / 85	236 / 86	241 / 87	244 / 88	250 / 89	

○ = to a limited extent



Page Reference for Planning Manual



Page Reference for Design Manual

	EKU-PORTA 40 GE	EKU-PORTA 100 GW	EKU-PORTA 100 GWF	EKU-PORTA 100 GW/GWF Synchro	HAWA-Junior 80/GS	HAWA-Junior 80/GL	HAWA-Junior 80/GP	HAWA- Purolino- Plus 80
								
		✓	✓	✓	✓	✓	✓	✓
	✓	✓			✓	✓	✓	✓
	✓	✓	✓	✓	✓			
						✓	✓	✓
	40	100	100	100	80	80	80	80
	6/8	8/10/12/12.7	8/10/12/12.7	8/10/12/12.7	8/10/12/12.7	8/9.5/10	8/10/12/12.7	8/10/12/12.7
							8.76 - 12.76	8.76 - 12.76
	✓	✓	✓		✓	✓	✓	✓
	○	✓	✓	✓	○	○	○	○
	✓	✓	✓	✓	✓	✓	✓	✓
	✓				✓	✓	✓	✓
	52	58	58	58	93	40	40	70
			✓	✓	○	○	○	✓
	✓	✓	✓		✓	✓	✓	✓
	○	○	○	○	✓	✓	✓	✓
	257 / 90	258 / 91	258 / 91	264 / 91	270 / 92	272 / 93	274 / 94	276 / 95

	HAWA-Puro 100	HAWA-Puro 150	Portavant 60	Portavant 120	Portavant 80 automatic
					
Ceiling Mounting	✓	✓	✓	✓	✓
Wall Mounting			✓	✓	✓
Clamping technology (no drill holes in the glass required)			✓	✓	✓
With patch suspension	✓	✓			
Max. weight per sliding door (kg)	100	150	60	80	80
Tempered glass (mm)	8/10/12/12.7	8/10/12/12.7	8/10	8/10/12	8/10/12
Laminated safety glass (mm)	8.76 - 12.76	8.76 - 12.76	8.76 - 10.76	8.76 - 12.76	8.76 - 12.76
Single door	✓	✓	✓	✓	✓
Double doors	✓	✓	✓	✓	✓
Anodised aluminium EV1	✓	✓	✓	✓	✓
Stainless steel look	✓	✓	✓	✓	✓
Profile height (mm)	50	50	57.5	70	70
Fixed sidelight possible	✓	✓	✓	✓	✓
Damping mechanism possible			✓	✓	✓
Protection against draughts, noise, cold and odours	✓	✓			
	285 / 96	285 / 96	299 / 97	306 / 98	315 / 99













 Page Reference for Planning Manual

 Page Reference for Design Manual



Bohle SlideTec optima 60













The Bohle SlideTec optima 60 sliding door hardware system is a high quality product for moving glass doors of up to 60 kg. Due to the smart clamping technology, pre-drilling the glass is no longer necessary either with or without optional damping mechanism (minimum door width 800 mm). The set (with damping mechanism) includes one damper for opening and one for closing.

	Ceiling mounting		8/10 mm tempered glass		Single door		Aluminium look
	Wall mounting		8.76 - 10.76 mm laminated safety glass		Double doors		Stainless steel look
	Up to 60 kg		Damping mechanism optional		Fixed sidelight		211



Bohle SlideTec optima 150













Bohle SlideTec optima 150 is a high quality sliding door hardware system for moving all-glass doors of up to 150 kg. Due to the smart clamping technology, pre-drilling the glass is no longer necessary either with or without the optional damping mechanism (minimum door width 800 mm). The system can be equipped with damping mechanisms both for the opening and closing directions (set), if required. The optima 150 system is suitable for tempered and laminated safety glass. It can additionally be retrofitted with the Synchro system, enabling glass doors to glide synchronously.

	Ceiling mounting		8/10/12 mm tempered glass		Single door		Aluminium look
	Wall mounting		8.76 - 12.76 mm laminated safety glass		Double doors		Stainless steel look
	Up to 150 kg		Damping mechanism optional		Fixed sidelight		225



Bohle SlideTec optima modul 80













Glass sliding doors offer a wide array of application possibilities in diverse living and working interiors. Apart from serving as interior doors, they are increasingly used as partitions. Whether they are used as partition walls for kitchens, walk-in closets or office partitions, the possibilities are unlimited. With this in mind Bohle has developed the compact but flexible SlideTec optima modul 80 system. One single track system and different accessory modules facilitate responding to different requirements - a broad range of applications from the single glass door to the double glass door system with 80 kg glass panes. Numerous application possibilities for single and double glass doors; wall, ceiling and concealed mounting (on request) and covers.

	Ceiling mounting		8/10 mm tempered glass		Single door		Aluminium look
	Wall mounting		laminated safety glass		Double doors		Stainless steel look
	Up to 80 kg		Damping mechanism optional		Fixed sidelight		236



Bohle SlideTec Premium













The SlideTec sliding door systems from Bohle have long since been established in the market. However, only standard applications have been available so far. This is reason enough for Bohle to add a Premium line to the very successful product range. SlideTec Premium can move doors with a weight of up to 150 kg, a door width of 1 m and a maximum height of 2.5 m almost without a sound. The new anti jump mechanism guarantees the user's safety even in high use areas. Also with this system, bespoke projects can be easily carried out.

	Glass fixing		8/10/12 mm tempered glass		Single door		Aluminium look
	Wall mounting		8.76 - 12.76 mm laminated safety glass		Double doors		Stainless steel
	Up to 150kg		Damping mechanism		Fixed sidelight		241



Bohle SlideTec













Stainless steel (AISI 1.304) and glass. A perfect combination for modern interiors. With the top quality SlideTec sliding door system by Bohle, any wall opening is transformed into an interior architectural feature. The space-saving system can also be installed in glass walls. The rollers of the Bohle SlideTec system glide quietly along an elegant rail and can support sliding doors up to 100 kg. The sleek, straight-lined design of this stainless steel system gives you endless possibilities for all modern interiors. If needed, these sets can also be individually supplemented by separate components from the SlideTec sliding door system.

	Glass fixing		10/12 mm tempered glass		Single door		Aluminium look
	Wall mounting		8.76 - 12.76 mm laminated safety glass		Double doors		Stainless steel
	Up to 100 kg		Damping mechanism		Fixed sidelight		244



Bohle SlideTec Premium Floor

The Bohle SlideTec Premium Floor sliding door hardware excels thanks to its timeless elegance. The system can move doors of up to 150 kg almost without a sound. It is ideally suited for space requirements where ceilings have a very limited static load capacity. The Bohle SlideTec Premium Floor sliding door hardware can be used with 10 - 12 mm glass. The running track can either be bonded or screwed to the floor.













	Ceiling mounting		10/12 mm tempered glass		Single door		Aluminium look
	Wall mounting		8.76 - 12.76 mm laminated safety glass		Double doors		Stainless steel
	Up to 150kg		Damping mechanism		Fixed sidelight		250



EKU-PORTA 40 GE

Sliding Door System













The EKU-PORTA 40 GE is a high quality sliding door hardware system that can effortlessly move all-glass doors weighing up to 40 kg. The EKU-PORTA 40 GE is ideal for sophisticated private living and office areas, and also makes a good impression in public offices. The simple, angular designer running track made from anodised aluminium with a clip-on cover is fitted to the wall. This means that the hardware system is also easy to retrofit during renovation, for example, because no alterations need to be made to the existing building structure. Thanks to the clever glass clamping shoes, there is no need to drill holes in the glass. The EKU-PORTA 40 GE is characterised by a play-free bottom guide and continuous height adjustment and has the proven EKU sliding and stopper technology. Thus the sliding door is guaranteed to glide smoothly. Now available with damping mechanism.

	Ceiling mounting		6/8 mm tempered glass		Single door	 Aluminium look  Stainless steel look  257
	Wall mounting		laminated safety glass		Double doors	
	Up to 40 kg		Damping mechanism optional		Fixed sidelight	



EKU-PORTA 100 GW / GWF Sliding Door System











The EKU-PORTA 100 GW/GWF is a proven fitting from the EKU-PORTA product range for sliding glass doors up to 100 kg. The EKU-PORTA GW/GWF fittings are even more impressive when flush-mounted to the ceiling: As the sliding technology disappears totally into the ceiling, the glass door, which is fastened by clamping shoes, floats freely in the room - a perfect illusion for design-orientated living and working environments. It is suitable for glass sliding doors with a maximum height of 2.70 m and a width of 1.60 m. The Synchro system has been added both to the EKU-PORTA 100 GW and EKU-PORTA 100 GWF systems, allowing two glass doors to slide synchronously through the running track.

	Ceiling mounting		8/10/12/12.7 mm tempered glass		Single door	 Aluminium look  Stainless steel look  258
	Wall mounting		8.76 - 12.76 mm laminated safety glass		Double doors	
	Up to 100 kg		Damping mechanism optional		Fixed sidelight	



HAWA-Junior 80/GS Sliding Door Hardware Set

The clamping mechanism of the Junior 80/GS hardware system by HAWA permits installation of all-glass sliding doors without having to drill into the glass. This means that you can offer your customers time-saving and flexible solutions. The proven HAWA sliding technology guarantees quality.

 <p>Ceiling mounting</p>	 <p>8/10/12/12.7 mm tempered glass</p>	 <p>Single door</p>	 <p>Aluminium look</p>  <p>Stainless steel look</p>
 <p>Wall mounting</p>	 <p>laminated safety glass</p>	 <p>Double doors upon request</p>	
 <p>Up to 80 kg</p>	 <p>Damping mechanism</p>	 <p>Fixed sidelight upon request</p>	



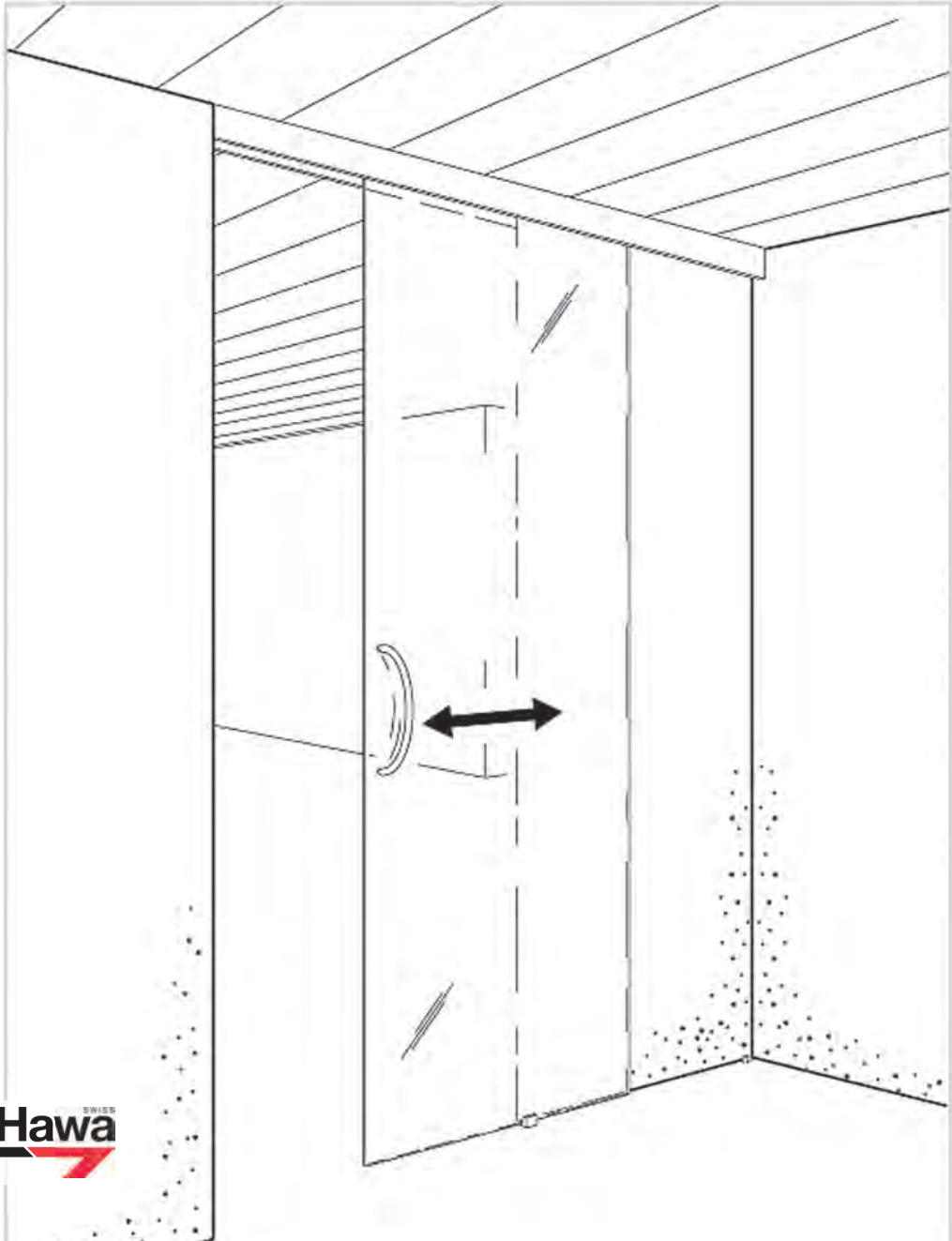









 270



HAWA-Junior 80/GL

Sliding Door Hardware Set













Ideal for designers and architects who prefer an unobtrusive, straight-lined design. Once again the tried and tested system proves itself. For all-glass doors up to 1200 mm wide and weighing up to 80 kg. The stopper technology with adjustable retainers ensures optimal comfort and user friendliness. The aluminium cover plates fit easily, using patented rubber clips which also prevent water from leaking into the profile. Wherever rooms need closing with unobtrusive, reliable all-glass sliding doors at optimum price/performance, e.g. in hotels, restaurants, conference rooms, airports, office buildings, or even private residential interiors and outdoor applications.

 Ceiling mounting  Wall mounting  Up to 80 kg	 8/9.5/10 mm tempered glass  laminated safety glass  Damping mechanism	 Single door  Double doors upon request  Fixed sidelight upon request	 Aluminium look  Stainless steel look  272
--	---	--	---



HAWA-Junior 80/GP Sliding Door Hardware Set













The Junior 80/GP sliding door hardware set by HAWA has set new standards for sliding glass door hardware. With its unobtrusive patch suspension it ensures that the visual qualities of any glass construction are shown to full advantage. Its various types of cover caps give it the finishing touch: round, square, with stainless steel look or matt chrome-plated. Acoustically it has also set new standards: with its smooth and quiet operation and special floor guide that prevents rattling. The Junior 80/GP sliding door hardware by HAWA is remarkably simple to install.

	Ceiling mounting		8/10/12/12.7 mm tempered glass		Single door	 Aluminium look  Stainless steel look  274
	Wall mounting		8.76 - 12.76 mm laminated safety glass		Double doors upon request	
	Up to 80 kg		Damping mechanism		Fixed sidelight upon request	



HAWA-Purolino-PLUS 80 Sliding Door Hardware Set













The HAWA-Purolino-PLUS 80 is ideal not only for wall and ceiling mounting but also for recessed ceiling applications. The two ceiling-mounting variants can be designed with or without fixed glass elements. The relevant components such as trolley, track stop and SoftMove 80 can be fitted and removed from underneath for each of the construction types. HAWA-Purolino-PLUS 80 makes an aesthetically appealing impression all round thanks to the cover and screen profiles that simply clip on when installation is complete.

 <p>Ceiling mounting</p>	 <p>8/10/12/12.7 mm tempered glass</p>	 <p>Single door</p>	 Aluminium look  Stainless steel look  276
 <p>Wall mounting</p>	 <p>8.76 - 12.76 mm laminated safety glass</p>	 <p>Double doors upon request</p>	
 <p>Up to 80 kg</p>	 <p>Damping mechanism</p>	 <p>Fixed sidelight upon request</p>	



HAWA-Puro 100-150 Sliding Door Hardware Set













Would you like to partition and design rooms with glass? Then you will be pleased with a hardware system that does justice to the elegance and transparency of this fascinating material. In combination with concealed suspensions, the HAWA-Puro 100-150 satisfy the aesthetic ideal of invisible hardware. High-quality ball bearing technology built into the system's trolleys enables you to slide doors weighing up to 150 kg smoothly and quietly along anodised top tracks. Transparency through total integration. Wherever glass/glass or glass/wood combinations are used as room partitioning and design elements, not only in hotels, restaurants, conference rooms and office buildings, but also for private interior design, especially in lofts with suspended ceilings.

	Ceiling mounting		8/10/12/12.7 mm tempered glass		Single door		Aluminium look
	Wall mounting		8.76 - 12.76 mm laminated safety glass		Double doors		Stainless steel look
	Up to 150 kg		Damping mechanism		Fixed sidelight		285



Willach Portavant 60 Sliding Door System













The versatile Portavant 60 is a slimline, lightweight sliding glass door system developed from the successful Portavant 120 range. The Portavant 60 system enables double sided damping with soft closing mechanism in very limited space conditions on door widths from just 380 mm, carried on a slimline profile just 57.5 mm deep.

	Ceiling mounting		8/10 mm tempered glass		Single door		Aluminium look
	Wall mounting		8.76 - 10.76 mm laminated safety glass		Double doors		Stainless steel look
	Up to 60kg		Damping mechanism		Fixed sidelight	 299	



Willach Portavant 120 Sliding Door System













Impressive features of Portavant are its easy installation and handling simplicity in all types of installation. The sophisticated clamping technology makes processing of the glass unnecessary. The suspension was developed to ensure that the panes are securely held by the clamping mechanism. But if there is a particular need, the clamping mechanism can be combined with a drilled hole in the glass and a securing pin. The elegant floor guide features easy adjustment to accommodate different glass thicknesses. The push-in plastic inserts enable 8-12 mm glass panes to be securely guided. There is no play in the guide, thus preventing the panes from rattling. The resistance of the floor guide is attuned to the reliable self-closing system.

 Ceiling mounting  Wall mounting  Up to 120 kg (80 kg)	 8/10/12 mm tempered glass  8.76 - 12.76 mm laminated safety glass  Damping mechanism	 Single door  Double doors  Fixed sidelight	 Aluminium look  Stainless steel look  306
---	--	--	---



Willach Portavant 80 automatic Sliding Door System

Did you think that due to their complex technology, automatic sliding door systems are only affordable in shopping malls or big hotels? That's far from the truth! Thanks to the low movement energy required and its intelligent control mechanism, Portavant 80 automatic can do without closing edge monitoring completely and thus addresses a broad target group at an attractive price. Whether it is installed in private living environments, offices, doctors' surgeries, hotels or restaurants, Portavant 80 automatic opens and closes all doors automatically and keeps your customers' hands free! The electrical connection can be carried out in only three steps with the well thought-out Plug&Go system. Portavant 80 automatic works for almost any application, regardless of whether one or two doors are involved. It can also be used for fixed sidelights and glass/wall installations!

	Ceiling mounting		8/10/12 mm tempered glass		Single door	 Aluminium look  Stainless steel look  315
	Wall mounting		8.76 - 12.76 mm laminated safety glass		Double doors	
	Up to 80 kg		automatic		Fixed sidelight	



Fittings for Pivot Doors

In the "Interior Fittings" division Bohle offers a diverse and highly specialised product range, including products from selected quality manufacturers and innovative in-house products. In this chapter you will find suitable sliding and hinged door systems for almost any situation. Door closing mechanisms and fittings for all-glass systems complete the list.

 **Bohle**

 **vitris**

 **Hawa**^{SWISS}





KL[®] **megla**

EKU
Sliding Solutions









Pivot Door Systems - At a Glance

				
Art. No.	BO 5206851+	BO 5206853+	BK 9483031+ BK 9483131+	BK 9433031+ BK 9433131+
Glass / glass 180°		✓		✓
Glass / wall 90°	✓		✓	
Max. door weight (kg)	70	70	65	65
Max. door width (mm)	1000	1000	1000	1000
Max. door height (mm)	2500	2500	2500	2500
Glass thickness tempered glass (mm)	8/10/12	8/10/12	10	10
Adjustable zero position	✓	✓	✓	✓
Hold position 90°	✓	✓	BK 9483131+	BK 9433131+
Aluminium	✓	✓		
Brass			✓	✓
Stainless steel				
Zinc				
Inspection according to DIN EN 18263 (500,000 cycles)	✓	✓		
	330	330	332	331

 Page Reference for Planning Manual

			
BO 5210382	BO 5210380	BO 5214170+	BO 5214340+
	✓	✓	✓
✓		✓	✓
60	60	100	85
915	915	1200	1100
		2500	2500
8/10/12	8/10/12	10/12	10/12/12.7
✓	✓		
✓	✓		
✓	✓		
		✓	✓
			✓
336	336	337	341

SELCO Self-closing Double Action Door Hinges

The new hinges for interior doors in both the private and commercial sectors are especially suitable for passageways. Mounting door closers is no longer necessary. High-quality. Excellent optical characteristics. Optimum functionality. Max. door weight 70 kg.

Technical data:

- For 8, 10 and 12 mm tempered glass
- Max. door width 1000 mm / max. door height 2500 mm
- Top quality silver anodised or stainless steel look
- Self-closing
- Holding position at 90°
- Simple mounting
- Adjustable zero position +/- 5°
- Mounting: glass/wall + glass/glass
- Simple glass processing
- Tested as per DIN EN 18263 with 500,000 cycles
- Suitable for high-humidity environments according to DIN EN 1670 / corrosion class 3



glass/wall



glass/glass

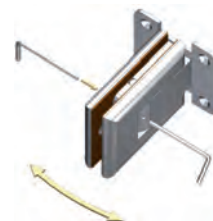

zero position adjustable



Chalet PT Swinging Door System

Chalet PT is a top quality swinging door system with a self-closing function, exclusively for use in living areas and less frequented office spaces. The system is designed for swinging doors only, opening in both directions. Limiting the door to swing in only one direction is not possible.

The Chalet PT swinging door hinges are available in three different versions:

- Without stops in the open position
- Stop in the open position at 90°
- Stop in the open position at 85°

Size and weights per pair of swinging door hinges:

- max. door weight: 65 kg
- door width: 1000 mm / min. door width: 700 mm
- max. door height: 2500 mm

The hinges are prepared for 10 mm tempered safety glass.

The tempered safety glass is to be processed per DIN EN 12150-1:2000.



glass/wall



glass/glass



TwistTec Pivot Door System

Stainless steel (AISI 1.304) and glass. A perfect combination for modern interiors. The TwistTec premium pivot door system from Bohle offers a range of versatile design options, whether for single or double glass doors, or in an all-glass construction or in a wall opening. With a minimum of components, frameless door applications which meet the high requirements of sophisticated interior design can be achieved. Fitting sets that include all necessary components are available for the most common door settings. If needed, these sets can also be individually supplemented by separate components from the TwistTec pivot door system.



Bohle Patch Corner Fitting System

The Bohle corner fittings for tempered glass are suitable for all standard types of all-glass assemblies. Any glass cut-outs and bore holes needed are uncomplicated and can be completed quickly and easily. Bohle attaches great importance to top quality products which ensure a long service life · suitable for all floor springs and transom door closers · suitable for interior and exterior glass assemblies · suitable for single action and swinging doors · for 10 mm, 12 mm and 12.7 mm tempered glass



Floor Springs

The floor springs stand out due to their particularly flat design. They are ideally suited for use with swinging doors. Optionally with 90° or 180° locking positions. Due to its numerous versions, this floor spring is suitable for almost any application.

- Excellent value for money
- Trouble-free installation thanks to particularly flat design
- Sturdy construction for doors weighing up to 200 kg
- Standard 10 mm plug-in conical floor spring axle included
- Incl. cement case, 49.5 mm high, and matt stainless steel cover plate
- Closing speed continuously adjustable via valve
- Tested to 500,000 closings



BO 5214010+



WSS Studio Private Line & Atelier Business Line Door Fittings

The interior door fittings for the private domestic interior which lives up to all demands:

- Noise-reducing internal plastic parts
- Nickel-plated brass latch bolt
- Single throw / 19 mm bolt projection
- Left and right hand installation
- Tested according to DIN 18251, class 3 (cycles: latch tests 200,000, bolt tests 50,000)
- Suitable for 8 - 10 mm tempered glass
- 61 mm profile cylinder, flush on counterplate side
- Suitable for standard lever handles without roses which are supplied with 8 mm square pin and 18 mm shoulder guide
- M5 stainless steel screws (torque setting 3 Nm)



Planet Door Sealing Profile

Ideal for sealing already installed smooth glass, metal, aluminium, wood and plastic doors · For mounting please use KG-S adhesive tape · Sealing strips can be trimmed. · Incl. set of cover caps · Sound insulation 48 DB · Further models / product versions upon request.

 379

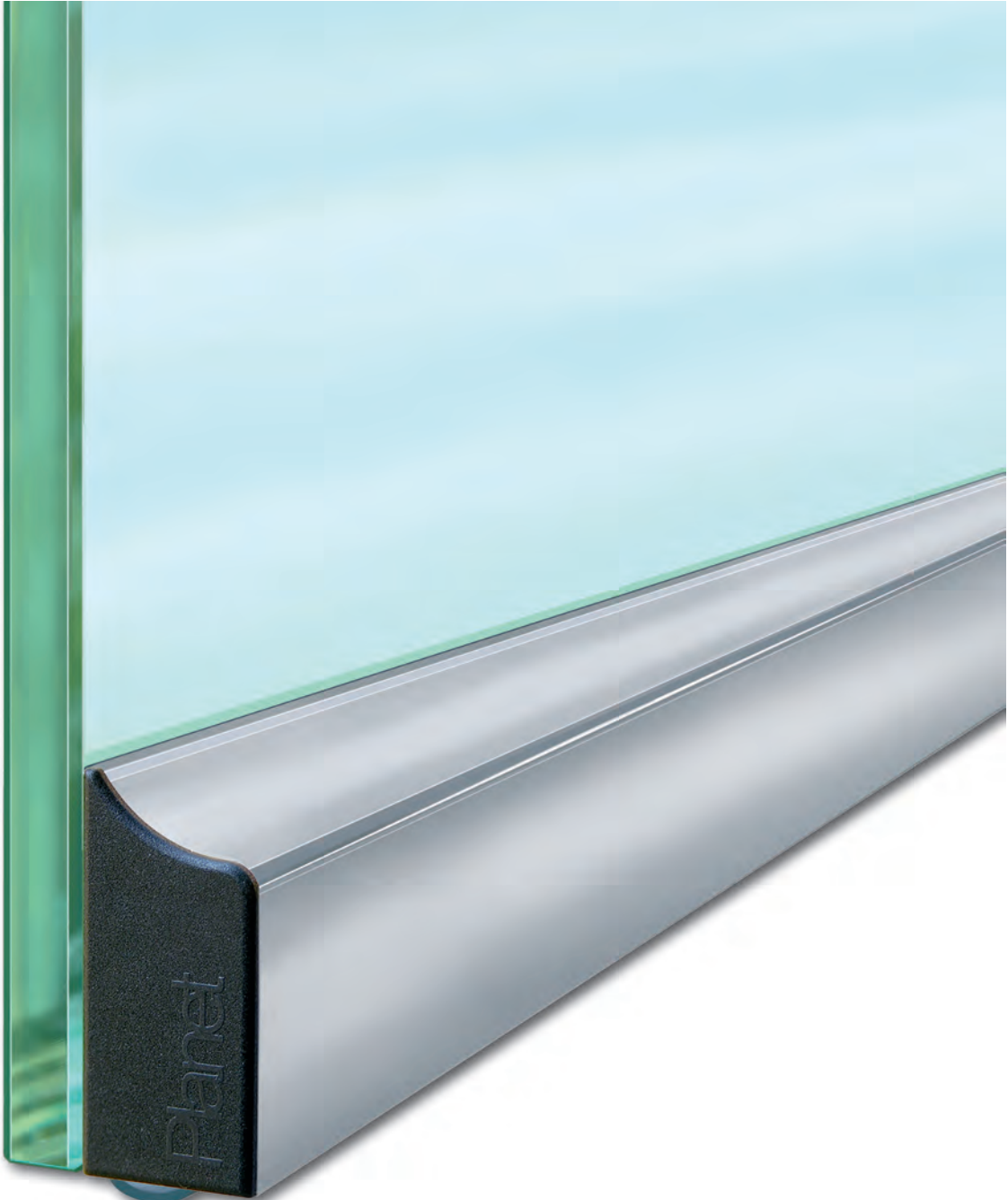
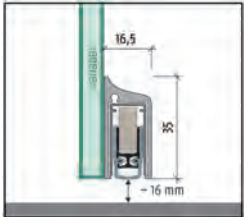

Accessories for Interior Fit-Out

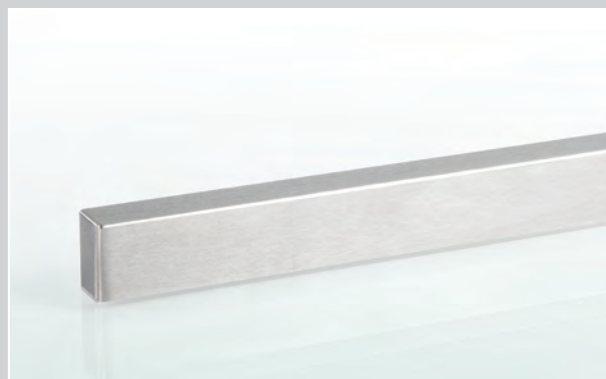





Glass Door Handles - At a Glance

With drill holes in the glass				
Art. no.	BO 5213740+	BO 5113701-10/5213749	BO 5113711-19/5213779/89-90	BO 5213759 /69
Stainless steel 1.304	✓	✓	✓	✓
Diameter (mm)	19	25	32	32 / 38
Length (mm)	250 - 1000	300 - 2000	300 - 2000	1000 - 1800
Distance between hole centres (c - c, mm)	150 - 800	200 - 1000	200 - 1000	800 - 1600
Height (mm)	52	65	72	72 - 80
Glass thickness tempered glass (mm)	0 - 12	6 - 12	6 - 12	6 - 12
Drill hole (mm)	10	14	14	14
	384	385	385	386

With drill holes in the glass				
Art. no.	BO 5215021/22	BO 5215027	BO 5215028+	BO 5215031/32
Stainless steel 1.304	✓	✓	✓	✓
Diameter (mm)	30 x 15	25 x 38	15 x 30	25 x 50
Length (mm)	450 - 600	1200	290 - 590	475 - 600
Distance between hole centres (c - c, mm)	300 - 540	1175	275 - 575	450 - 575
Height (mm)	70	80	55	65
Glass thickness tempered glass (mm)	0 - 12	6 - 12	6 - 12	6 - 12
Drill hole (mm)	14	14	10	14
	388	388	389	389

Without drill holes in the glass				
Art. no.	BO 5113738+	BO 5205105	BO 5205109	BO 5113752+
Stainless steel 1.304	✓	✓	✓	
Diameter (mm)		64		
Length (mm)	35 x 300 - 600		60 x 60	110 x 60 / 200 x 60
Interior opening (mm)				70 x 30 / 160 x 30
Height (mm)	8 - 20	10	10	9
Self-adhesive	✓	✓	✓	✓
	386	390	391	391

				
BO 5213819	BO 5213888	BO 5213829	BO 5213859	BO 5213879
✓	✓	✓	✓	✓
32	38 x 20	32	32	32
600	600	600	600	500
568	400	400	568	468
72	60	72	80 / 45	80
0 - 12	0 - 12	0 - 12	0 - 12	0 - 12
14	14	14	14	14
386	387	387	387	388

		
BO 5214216N	BO 5214217N	BO 5101615
✓	✓	✓
65	65	65 x 65
6.8	9	7
8, 10, 12	8, 10, 12	8 + 10
50	50	50
389	390	390

	
BO 5113770+	BO 5113785+
	65
60 x 60	
35 x 35 / 40 x 40	
8 / 9	7 / 9
✓	✓
391	392

Glass Door Handles - round & square

Good products can be felt: When you choose our glass door handles and knobs you not only get excellently designed quality products which are easily and quickly installed - but one "grip" tells you that you made the right decision.





Flush Handles

Reduced to the max. Handle applications as a fixed connection to the glass - either for screw-fixing, UV bonding or as self-adhesive version. Bohle offers user-friendly products to suit all tastes.

 389

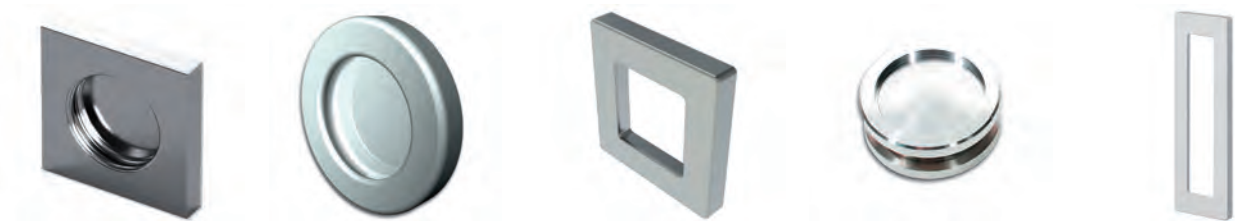

Glass Connectors and Point Fixings

Establish connections - new ideas - new applications



Hardware for Furniture

Our "Hardware for Furniture" portfolio includes both fittings that require drill holes in the glass and those that do not require pre-drilled holes. Furthermore you will find all the fittings which are suitable for UV bonding. This product division also provides you with the complete range of accessories for constructing glass/glass or glass/wood furniture.



Bohle

EKU
Sliding Solutions

vitris

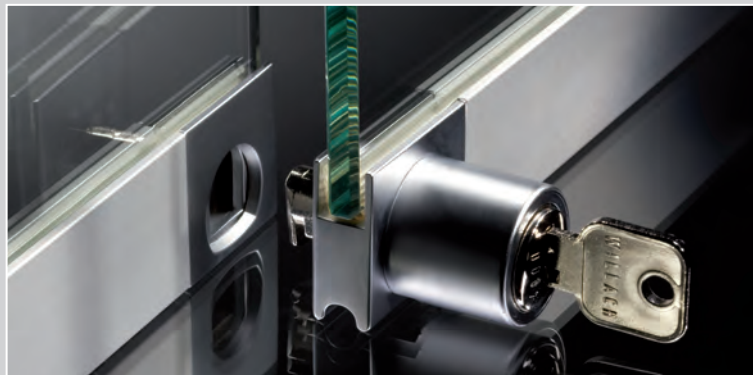

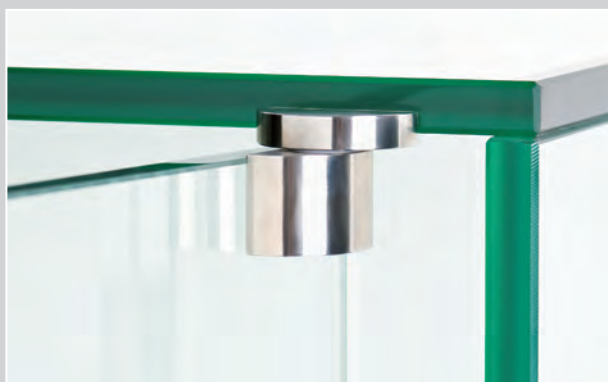







Glass Door Hinges - At a Glance



Glass/ Glass						
Art. no.	BO 5205231	BO 5205241	BO 5205242	BO 5200062	BO 5200066	BO 5200067
Inset	✓		✓	✓	✓	✓
Overlay	✓	✓			✓	
Glass door weight in kg when used in pairs	8	10	10	5	5	10
Glass thickness (mm)	5 / 6	5 / 6 / 8	5 / 6 / 8	6 / 8	6	6 / 8
Requiring drill holes	✓	✓	✓	✓	✓	✓
	427	429	429	431	432	432

Glass/ Wood						
Art. no.	BO 5205271	BO 5205221	BO 5205211	BO 5200051	BO 5200053	BO 5200052
Inset	✓		✓	✓	✓	✓
Overlay		✓				
Glass door weight in kg when used in pairs	8	8	8	16	16	25
Glass thickness (mm)	4 / 6	5 / 6	5 / 6	6 / 8	6 / 8	6 / 8
Requiring drill holes	✓	✓	✓	✓	✓	✓
	424	426	426	427	428	428

Glass/ Wood						
Art. no.	BO 5205262	BO 5205266	BO 5200061	BO 5200059	BO 5200063	BO 5200071
Inset	✓	✓	✓	✓	✓	✓
Overlay						
Glass door weight in kg when used in pairs	10	10	2	4	7.5	2.5
Glass thickness (mm)	4 / 5 / 6	5 / 6	4 / 5 / 6	4 / 5 / 6 / 8	4 / 5 / 6 / 8	6 / 8
Requiring drill holes						
	434	434	434	435	435	437

						
BO 5200064	BO 5200056	BO 5200058	BO 5200060	BO 5200055	BO 5200057	BO 5200054
✓			✓	✓	✓	✓
✓	✓	✓			✓	✓
10	1	2	2	4	4	5
8	4 / 5 / 6	4 / 5 / 6	4 / 5 / 6	4 / 5 / 6 / 8	4 / 5 / 6 / 8	4 / 5 / 6 / 8
✓						
432	435	436	436	436	437	437

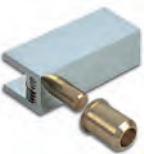
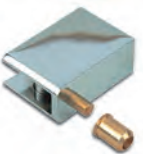
						
BO 5205245	BO 5205246	BO 5200065	BO 5200069	BO 5200068	BO 5205281	BO 5205265
✓	✓	✓	✓	✓	✓	✓
10	10	5	10	15	7.5	4
5 / 6 / 8	5 / 6 / 8	6 / 8	6 / 8	6 / 8	5.2	4 / 5 / 6
✓	✓	✓	✓	✓		
429	430	430	431	431	433	433

		
BO 5200070	BO 5200073	BO 5203000/2
✓	✓	✓
		✓
5	8	10
4 / 5 / 6	6 / 8	4 / 6
		✓
438	438	424





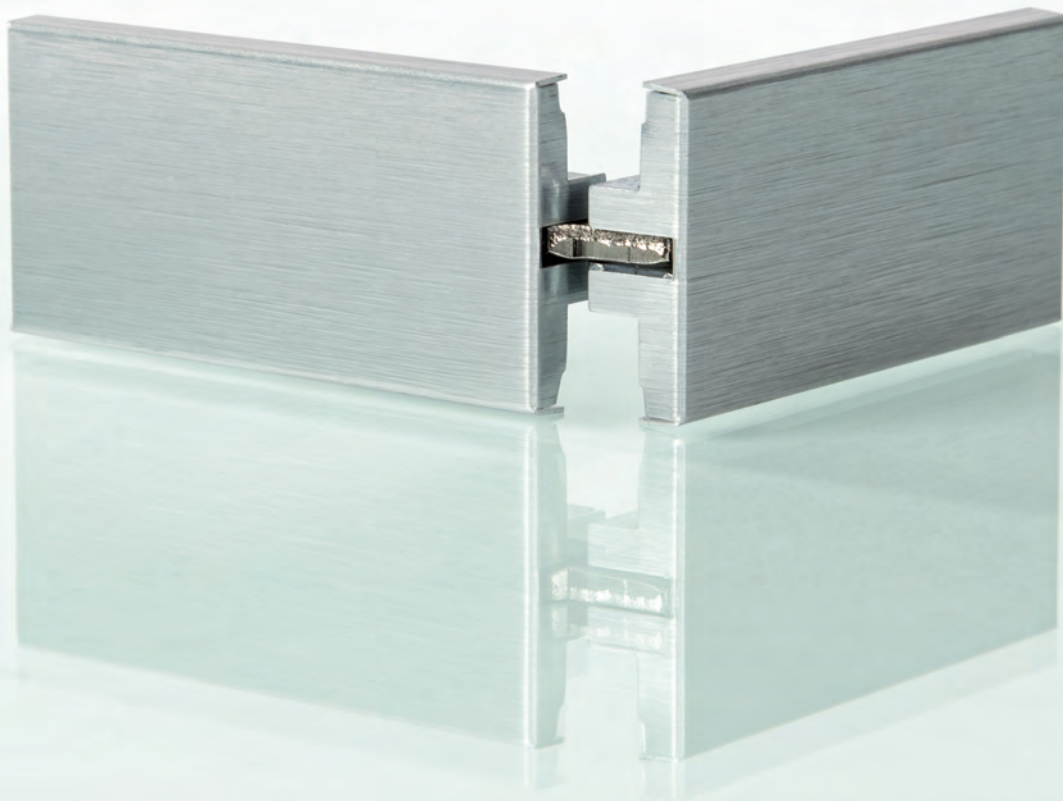

Glass Door Hinges with or without glass processing





Different hinges for the most diverse applications. Whether for furniture, bathrooms or customised projects, Bohle offers suitable hinges for any application. This important product division includes hinges for inset, overlay and semi-overlay doors in different versions and designs.











Glass Door Locks - At a Glance

					
Art. no.	BO 5206515	BO 5206530	BO 5206525	BO 5206540	BO 5206501
For pivot doors	✓	✓	✓	✓	✓
For sliding doors					
For single doors	✓	✓		✓	
For double doors		✓	✓		✓
Universal key	✓	✓	✓		✓
Individual key	*	*	*	✓	
Glass thickness (mm)	4 / 5 / 6 / 8	4 / 5 / 6 / 8	4 / 5 / 6 / 8	4 / 5 / 6	6
With drill holes in the glass	✓	✓	✓	✓	✓
Without drill holes					
	442	442	443	443	444

				
Art. no.	BO 5206360+	BO 5206510	BO 5206520	BO 5206358+
For pivot doors	✓	✓	✓	
For sliding doors				✓
For single doors	✓	✓		✓
For double doors			✓	
Universal key	✓	✓	✓	✓
Individual key	✓	*	*	✓
Glass thickness (mm)	5 / 6 / 8 / 10 / 13	4 / 5 / 6 / 8	4 / 5 / 6 / 8	4 / 5 / 6
With drill holes in the glass	✓			✓
Without drill holes		✓	✓	
	448	450	450	449

* = on request
 ** = to a limited extent

 Page Reference for Planning Manual

					
BO 5206401	BO 5206309/10	BO 5206311	BO 5206340-45	BO 5206346-51	BO 5206352-57
✓	✓	✓	✓	✓	✓
			✓**	✓**	
✓	✓	✓	✓	✓	✓
✓	✓	✓	✓	✓	✓
	✓		✓	✓	✓
8	6 / 8	6 / 8	6	8	6 / 8
✓	✓	✓	✓	✓	✓
444	444	445	445	446	447

Glass Door Locks with or without glass processing

When selecting glass door locks, security as well as design are important criteria. In this section you can find high quality locks in different designs which meet a range of application requirements.













Showcase Shelf Supports - At a Glance

Glass / Wall				
Art. no.	BO 5207321	BO 5206911/2	BO 5206913/4	BO 5200040
Max. shelf weight (kg)	5	5	5	5
Max. shelf projection (mm)	200	150	150	
Glass thickness (mm)	8 - 10	8 - 10	8 - 10	
Single-sided	✓	✓	✓	✓
Double-sided				
With drill holes in the glass				
Without drill holes	✓	✓	✓	✓
	464	464	465	465

Glass / Wall				
Art. no.	BO 5200041/42	BO 5212036-39	BO 5201800-20	BO 5201825-45
Max. shelf weight (kg)	5	50/32	50/32	50/32
Max. shelf projection (mm)		300/400	300/400	300/400
Glass thickness (mm)	6 - 8	10	10	8
Single-sided	✓	✓	✓	✓
Double-sided				
With drill holes in the glass	✓			
Without drill holes		✓	✓	✓
	467	458	459	459

Glass / Wall				
Art. no.	BO 5206915-19	BO 5206900-04, BO 5106911	BO 5206905-08, BO 5306911	BO 5207200-04, BO5107211
Max. shelf weight (kg)	5	5	10	5
Max. shelf projection (mm)	150	160	200	200
Glass thickness (mm)	6 - 10	6 - 10	6 - 10	6 - 10
Single-sided	✓	✓	✓	✓
Double-sided				
With drill holes in the glass				
Without drill holes	✓	✓	✓	✓
	461	462	462	462

					
BO 5200047	BO 5200075	BO 5200077	BO 5200072	BO 5200074	BO 5200076
5	5	5	5	10	10
6 - 10	4 - 6	4 - 8	6 - 8	6 - 8	6 - 8
✓	✓	✓	✓	✓	✓
✓					
	✓	✓	✓	✓	✓
467	465	465	465	466	466

					
BO 5206941/45	BO 5206951/55	BO 5206961/65	BO 5207331/35	BO 5207221/315	BO 5207301
10	14	20	10	10	5
160	200	250	160	160	150
3 - 15	3 - 25	5 - 35	3 - 15	3 - 25	6 - 8
✓	✓	✓	✓	✓	✓
✓	✓	✓	✓	✓	✓
458	460	460	460	461	461

					
BO 5207209, 5207211-14	BO 5207000-04, BO 5107011	BO 5207011-19	BO 5207101-11	BO 5200048	BO 5200043/44
10	5	10	5	5	5
200	200	200	150		
6 - 10	6 - 10	6 - 10	6 - 10	6 - 10	6 - 8
✓	✓	✓	✓		
				✓	✓
				✓	✓
✓	✓	✓	✓		
463	463	463	464	467	467





Showcase Shelf Supports



The comprehensive range of glass shelf supports in different models combines flexible application possibilities, high quality as well as interesting designs.



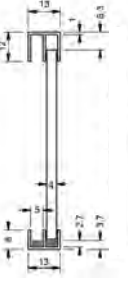

Fittings for Sliding Glass Doors - At a Glance

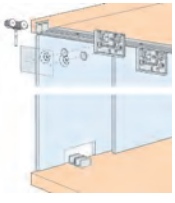
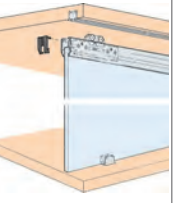
Sliding Door Applications for Furniture	Vitris supra	Vitris robustus	Vitris penda / bipenda	Dura Durus
				
With damping mechanism				
Glass thickness (mm)	4 - 8	8 - 12.76	≤ 8	4 / 6
Max. door weight (kg)	25 / 50	70 / 140	25 / 50	
	473	481	488	492

Sliding Door Applications for Furniture	EKU CLIPO 16	EKU CLIPO 35	Basic
			
With damping mechanism	✓		
Glass thickness (mm)	6	6 + 8	5 - 6
Max. door weight (kg)	16	35	25 / 50
	494	497	504

 Page Reference for Planning Manual



Willach vitris Fittings for Sliding Showcase Doors

Vitris is the perfect product in all situations where glass requires the perfect frame. It is a complete range consisting of profiles, fittings and locks for interior, showcase, shop or trade show furnishings. All system components are precisely coordinated and allow for many different combinations to take account of the greatest variety of dimensions and glass thicknesses. Outstanding features of the system are the screwless roller assembly and the integrated damping device. Vitris is the modular fittings system to meet the most demanding requirements regarding long-lasting function, aesthetic design, high security and trouble-free assembly.









EKU-Clipo Sliding Glass Door Fittings

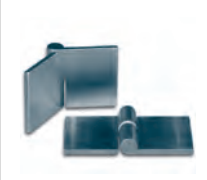





EKU-Clipo, the original among sliding door systems, impresses with its unobtrusive and technically well thought-out design. The practical EKU clip-on system makes the installation simple and thanks to the intelligent EKU height adjustment the door can be aligned very easily. In addition, the integrated EKU damping mechanism makes EKU-CLIPO convenient to handle. The fact that EKU-Clipo does not need a groove in the floor or a cover, gives the system a slender and elegant appearance. This sliding door system is suitable for light wooden, glass or aluminium frame doors from 16 kg up to 35 kg for residential, office and project applications.









UV Glass Door Hinges - At a Glance



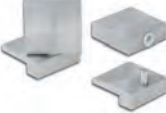
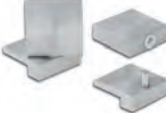

Glass/Glass					
Art. no.	BO 5206265/7	BO 5200090	BO 5205247	BO 5206060	BO 5206057
Inset	✓	✓	✓	✓	✓
Overlay				✓	
Glass door weight in kg when used in pairs	10	7.5	20	4-10	8
Glass thickness (mm)	4 - 10	4 - 10	4 - 10	6 - 15	6 / 8
	514	514	515	515	517

Glass/Glass		
Art. no.	BO 5206252	BO 5206251
Inset		
Overlay	✓	✓
Glass door weight in kg when used in pairs	10	30
Glass thickness (mm)	6 - 10	6 - 15
	519	519

Glass/Wood					
Art. no.	BO 5206068	BO 5206058	BO 5206055	BO 5206262	BO 5206263
Inset	✓	✓	✓	✓	✓
Overlay	✓				
Glass door weight in kg when used in pairs	4-10	8	8	10	20
Glass thickness (mm)	5 - 8	6 / 8	6 / 8	4 - 12	4 - 12
	520	521	521	522	522

 Page Reference for Planning Manual

						
BO 5206200	BO 5206199	BO 5206260	BO 5206261	BO 5500281	BO 5500283	BO 5500285
✓	✓	✓	✓	✓	✓	✓
8	8	10	20	10	20	5.5
6 / 8	6 / 8	4 - 12	4 - 12	6 - 12	6 - 12	6 - 15
517	517	517	518	518	518	519

				
BO 5500282	BO 5500284	BO 5500286	BO 5205248	BO 5206266/8
✓	✓	✓	✓	✓
10	20	5.5	20	10
4 - 12	4 - 12	6 - 15	4 - 10	4 - 15
522	523	523	523	524

Sliding Glass Door Fittings for UV Bonding

Due to its transparency and luminosity, glass has always been a favoured material when building furniture. Glass has been used to an increasing extent in recent years - whether in building construction or for interior decoration. Today a large range of all-glass furniture is available at attractive prices. The use of glass in combination with wood is also becoming increasingly popular.



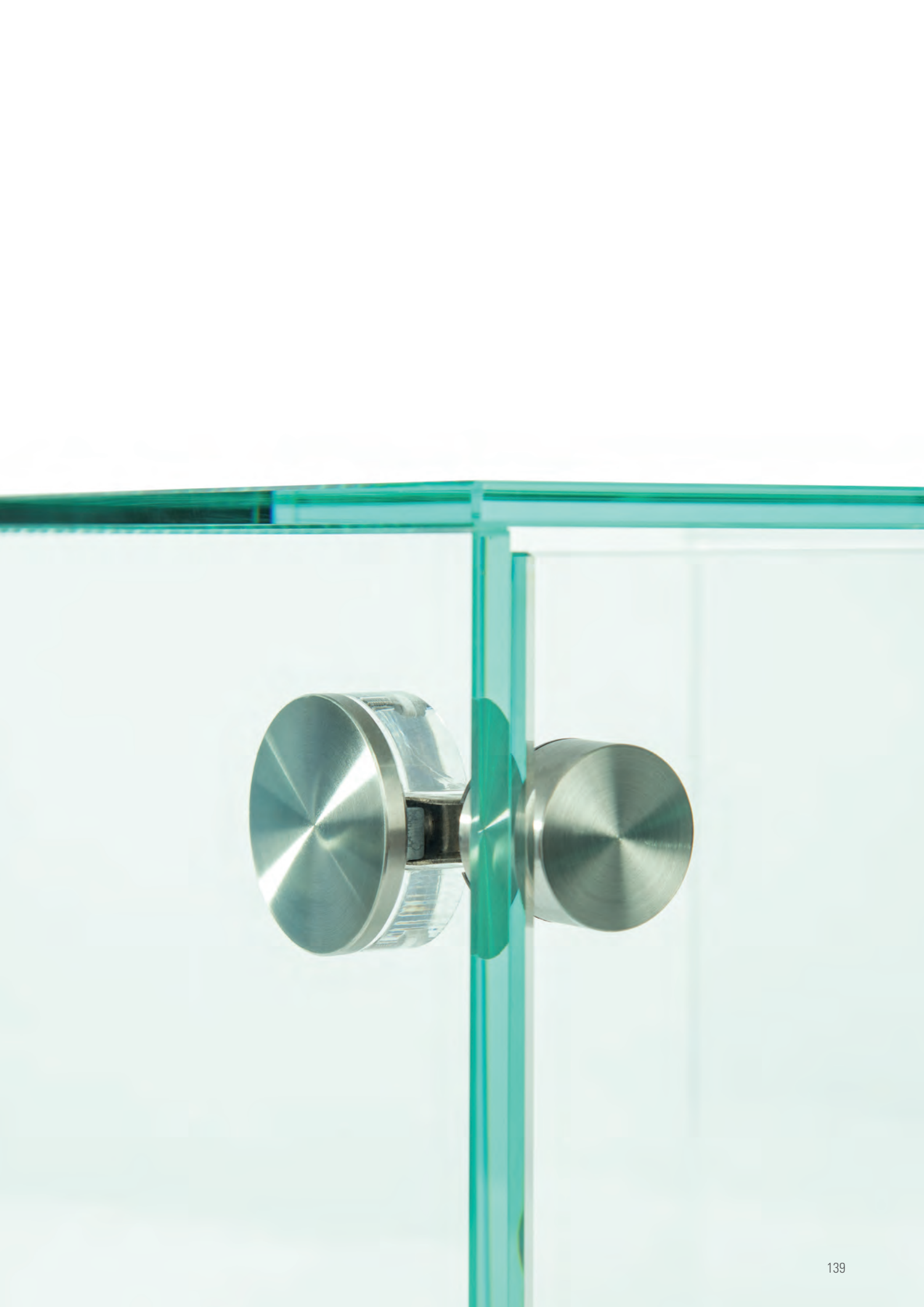

Glass Door Locks - At a Glance

				
Art. no.	BO 5500225-8	BO 5206240	BO 5206242	BO 5206281/82
For single doors	✓	✓		✓
For double doors	✓		✓	
Universal key	✓	✓	✓	✓
Individual key	✓			
Glass thickness (mm)	4 - 15	6 - 15	6 - 15	6 - 12
With drill holes in the glass		✓	✓	
Without drill holes	✓			✓
	526	526	526	527

				
Art. no.	BO 5206283	BO 5206278	BO 5206279	BO 5206280
For single doors		✓	✓	
For double doors	✓			✓
Universal key	✓	✓	✓	✓
Individual key				
Glass thickness (mm)		5 - 12	5 - 12	5 - 12
With drill holes in the glass				
Without drill holes	✓	✓	✓	✓
	527	527	528	528

 Page Reference for Planning Manual

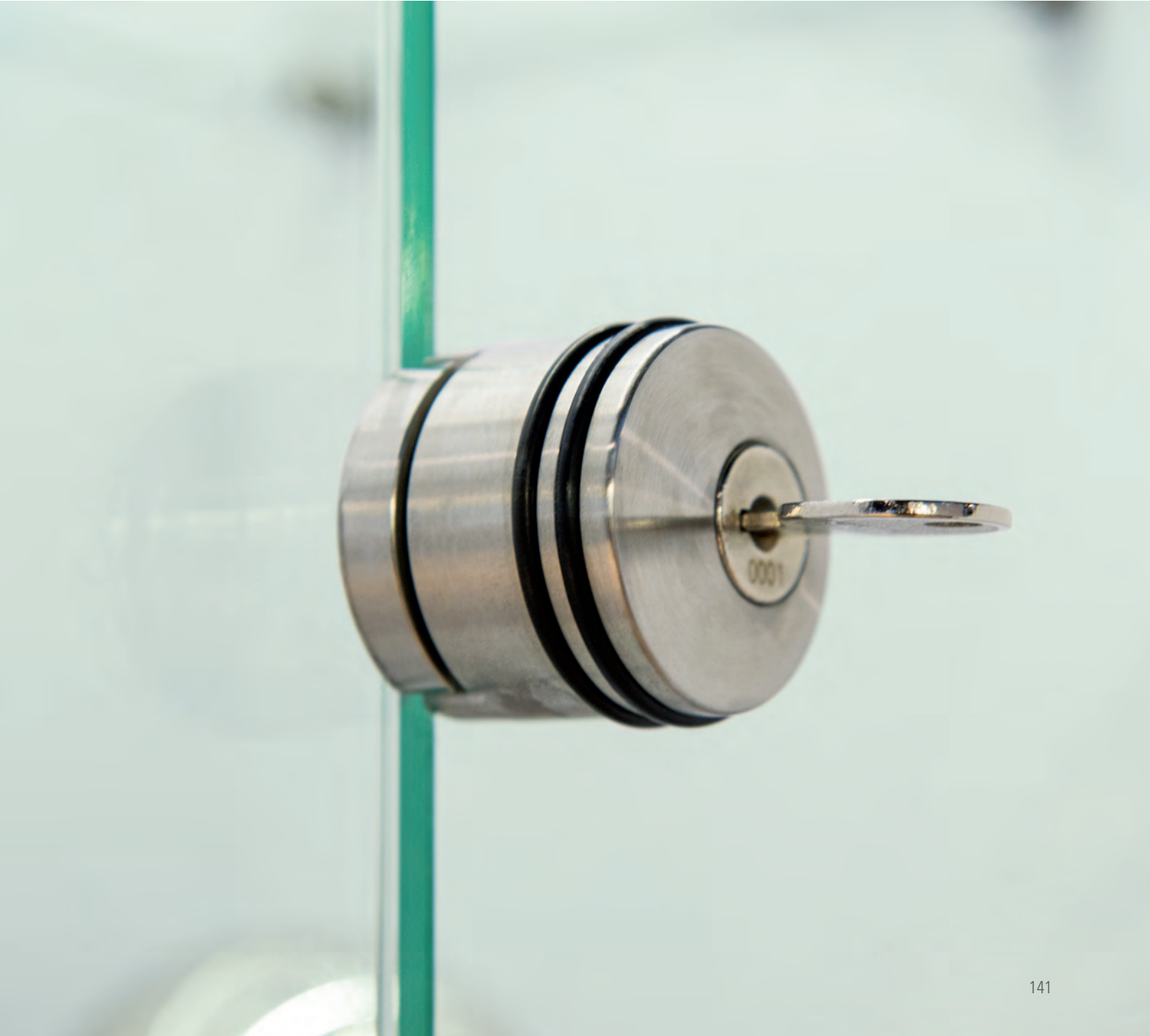

Glass Door Locks for UV Bonding







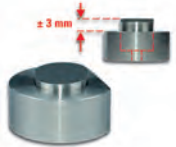
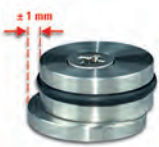

Showcase Shelf Supports - At a Glance

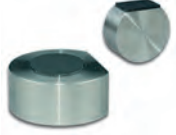
Glass / Glass				
Art. no.	BO 5206192	BO 5206193	BO 5206194	BO 5206195
Max. shelf weight (kg)	20	10	20	10
Glass thickness (mm)	4 - 10	4 - 10	4 - 10	4 - 10
 Page Reference for Planning Manual	544	544	544	545

Glass / Glass			
Art. no.	BO 5206196	BO 5206191	BO 5206198
Max. shelf weight (kg)	10	10	15
Glass thickness (mm)	4 - 10	4 - 10	4 - 10
 Page Reference for Planning Manual	545	545	545

 Page Reference for Planning Manual

Showcase Shelf Supports for UV Bonding



Hardware for Balustrades

In the "Hardware for Balustrades" division, Bohle offers not only complete balustrade systems but also a wide selection of clamps for tempered and laminated safety glass. All products are type-inspected and have usually been granted the corresponding ABZ, ABP, ETA and ETB certifications. Customised solutions for your individual project are available upon request.

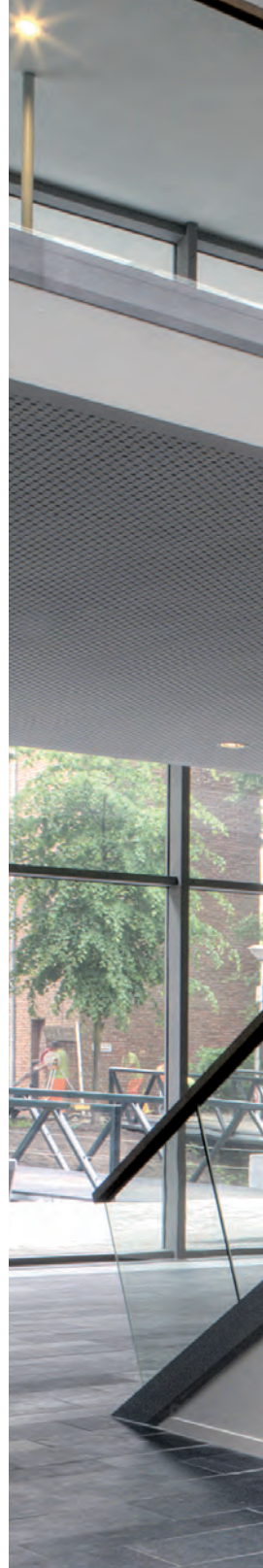

 Bohle



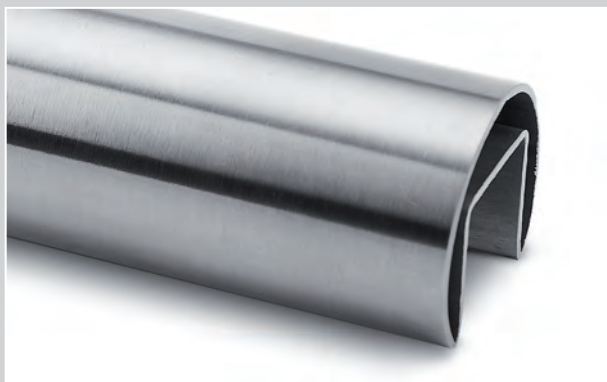

Railing Systems at a Glance

Slender and Elegant Design

The Bohle EasyMount *Fix* systems enable you to install all-glass railing systems quickly and simply. The stylish system offers high levels of transparency with various application possibilities. The Bohle EasyMount *Vario* systems also give you the ability to precisely align glass panels.

Simple Installation and Profitability

Bohle EasyMount systems pay off.

Staff costs during installation or for developing alternative applications are reduced.

- Quick and simple installation
- Flexible linear alignment
- Glass panes can be exchanged quickly from above or from one side without problems
- No cut-outs or drill holes in the glass required
- No filling compound required for fixing the glass in the profile
- Simplified planning

Bespoke Projects





We offer the ideal application for any requirement. Thanks to the great number of different profiles, Bohle offers an appropriate application for any construction project. If you do not find what you are looking for, please do not hesitate to contact us.

- Water drainage openings in profiles
- Flush profile extensions via connecting pins
- Anodised 25µ coating, salt water resistant
- Length of aluminium materials 2500 mm and 5000 mm
- Save time due to simple installation and user-friendly instruction manual
- Inside and outside corners available for all systems

Safety

“General Building Inspection Test Certificate” (AbP)



Bohle EasyMount				
	Top	Top	Top L	Top L
Top mount	✓	✓		
Top mount with extended fixing plate			✓	✓
Side mount				
Side mount with extended fixing plate				
Rail load (kN)	1.0	2.0 (3.0)*	1.0	2.0 (3.0)*
Length (mm)	2500 / 5000	2500	2500 / 5000	2500
	556	560	564	568

				
	Side	Side	Side L	Side L
Top mount				
Top mount with extended fixing plate				
Side mount	✓	✓		
Side mount with extended fixing plate			✓	✓
Rail load (kN)	1.0	2.0 (3.0)*	1.0	2.0 (3.0)*
Length (mm)	2500 / 5000	2500	2500 / 5000	2500
	572	577	581	586

* Verification for other countries will follow. For more information please visit www.bohle-group.com

 Page Reference for Planning Manual

Bohle EasyMount *Fix* and EasyMount *Vario*

EasyMount *Fix*

The EasyMount *Fix* Glass Mounting Kits enable quick and easy installation. The intelligent modular system allows the use of the same profile, no matter which system you choose, either *Fix* or *Vario*.

EasyMount *Vario*

The EasyMount *Vario* Glass Mounting Kits enable quick and easy installation. With a simple sliding movement the system can be adjusted by up to 40 mm. The Bohle mounting tool B0 5215281 enables you to work from the accessible side, making installation less time consuming.



Single Point Fixings

Point fixings for interior and exterior applications. With Bohle point fixings there are no limits to your creativity, whether for railing systems, interior work or entire wall cladding. Adjustable and easy to install, Bohle point fixings are an enhancement to any modern construction project.

 599



BO 5214026+







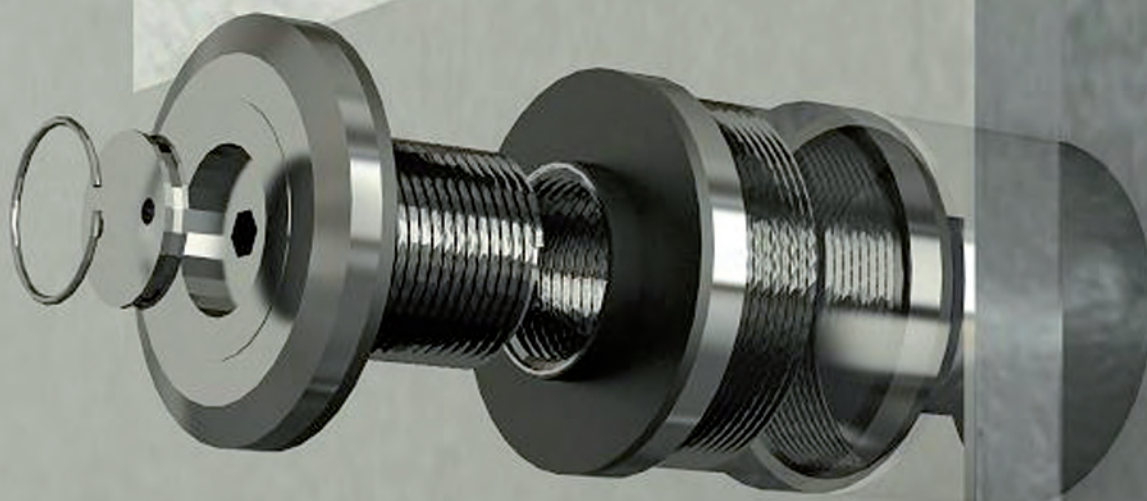

BO 5214030+









BO 5214060+



Clamps

					
Size (mm)	45 x 45	50 x 40	63 x 45	63 x 45	55 x 55
Tempered glass (mm)	6 / 8 / 10	6 / 8	6 / 8 / 10		8 / 10 / 12
Laminated safety glass (mm)				8.76 / 10.76	
Square tube (mm)	28	24	28	28	34
Round tube \varnothing (mm)	42 ^a	33 / 42 ^a	42 / 48 ^a	42 / 48 ^a	42 / 48 ^a
Wood					
Securing pin			BK 55001002	BK 55001002	BK 55001001
Securing plate					
Safety bracket					
Drill hole in glass (mm)			8	8	8
Certificates	2 / 3 / 7 / 8 / 9	2 / 3 / 7 / 8 / 9	2 / 5 / 7 / 8 / 9	2 / 4 / 7 / 9	2 / 5 / 7 / 8 / 9
	618	620	623	651	626

				
Size (mm)	\varnothing 30	\varnothing 42 / 60	60 x 70	70 x 70
Tempered glass (mm)	6 / 8 / 10 / 12 / 13 / 15 / 16	8 / 10 / 12		
Laminated safety glass (mm)			12.76 - 21.52	12.76 - 21.52
Square tube (mm)	30	✓ ^b	< 16.76 = 37 > 16.76 = 41	
Round tube \varnothing (mm)	42 ^a	✓ ^b		42 ^a
Wood	✓			
Securing pin				
Securing plate				
Safety bracket			BK 15590555 BK 15595555	BK 15590555 BK 15595555
Drill hole in glass (mm)	16			
Certificates	2 / 8 / 9	2 / 8 / 9	2 / 3 / 7 / 8 / 9	2 / 4 / 6 / 7 / 9
	641	644		669
			669	671

						
55 x 55	60 x 55	60 x 55	49 x 45	49 x 45	60 x 69	60 x 69
	8 / 10 / 12		8 / 10 / 12		8 / 10 / 12 / 13 / 15 / 16	
8.76 / 10.76 / 12.76		8.76 / 10.76 / 12.76		8.76 / 10.76 / 12.76 / 13.52		8.76 / 9.52 / 10.76 / 11.52 / 12.76 / 13.52
34	34	34	30	30	34	34
42 / 48 ^a	40 / 48 / 60 ^a	40 / 48 / 60 ^a	42 ^a	42 ^a	42 ^a	42 ^a
BK 55001001	BK 55001001	BK 55001001	BK 55001002	BK 55001002	BK 55001001	BK 55001001
			BK 10323500	BK 10323500		
8	8	8	8	8	8	8
2 / 4 / 7 / 9	2 / 5 / 7 / 8 / 9	2 / 4 / 7 / 9	9	9	2 / 5 / 7 / 8 / 9	2 / 4 / 6 / 7 / 8 / 9
654	629	657	633	661	635	663

✓ already provided or suitable

- 2 Surcharge per RAL special colour, see accessories
- 3 National Technical Approval granted (The National Technical Approval Certificate is available as pdf on request; all dimensions and framework conditions according to National Technical Approval).
- 4 German General Certificate of Inspection, valid (in conjunction with TRaV) for indoor use when used with securing pin or safety bracket or in corner areas, depending on the specific installation situation.
- 5 German National Technical Approval granted, valid for use with or without securing pin
- 6 German National Technical Approval granted, valid for outdoor use when used with securing pin or safety bracket or in corner areas, depending on the specific installation situation.
- 7 European Technical Approval (ETA) granted
- 8 The products were type tested by TÜV Rheinland (German Technical Inspection Agency)
- 9 Stainless steel

^a Standard diameter, other diameters available on request

^b For mounting to square tube and round tube, 42.2 mm and 60 mm with screw-on part (BK 10550+, BK 10560+, BK 10570+)

All technical drawings are available as pdf file. We can either send them to you by email or you can find them in our Online Shop.

Clamps

In the „Hardware for Balustrades“ division you will find clamps for tempered glass and laminated safety glass up to a total thickness of 21.52 mm. The clamps are manufactured either of diecast zinc or stainless steel and are supplied with fixing screws (stainless steel VA) and cover caps which match the finishes of the clamps.

 603



BO 70050+

BO 70150+

BK 10240+

BK 10580+

BK 10525+









Hardware for Canopies

In the "Hardware for Canopies" chapter you will find high quality and design-orientated systems for canopy constructions.



Bohle



Canopy Systems	Bohle Serif	Bohle Smart	Canopy System
			
Drill hole in glass	✓		✓
max. glass projection (mm)	1220	1200	1500
Stainless steel	✓	✓	✓
Without drill holes in glass		✓	
	676	677	678

 Page Reference for Planning Manual

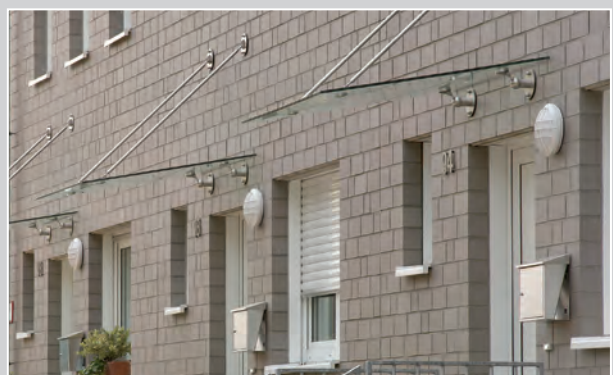

Fischer Fixing Technology



680



Universal plug



SX expansion plug



Aircrete anchor



FAZ II Bolt Anchor



High performance anchor



Germany

Bohle AG
Dieselstraße 10
D - 42781 Haan

T +49 2129 5568-0
F +49 2129 5568-201

info@bohle.de

South Africa

Bohle Glass Equipment (Pty) Ltd.
Unit 3, Graphite Industrial Park
Fabriek Street,
Strijdom Park 2125, Gauteng

T +27 11 792-6432
F +27 11 793-5634

info@bohle.co.za

USA

Bohle America, Inc.
10924 Granite Street
Suite 200
Charlotte, NC 28273

T +1 704 247 8400
F +1 704 247 8420

info@bohle-america.com