



Fittings for glass

---

Best Sellers





# The Bohle Online Shop

The Bohle Online Shop offers you our latest product range around the clock in a clearly structured and informative way.

The Online Shop, launched in 2015, has a clearer layout, improved functionality and is optimised for all digital devices.

[www.bohle-group.com](http://www.bohle-group.com)



Optimised for all digital devices.



Clearly structured product presentation with filter function.



Convenient search function.



Secure customer area with online and offline order history.



New offers and deals.

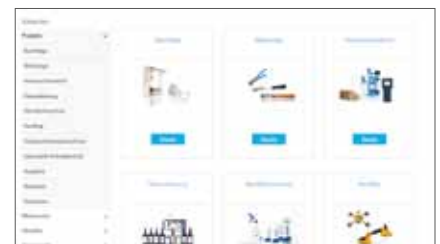

24/7 the latest product portfolio.

# Notepads are a thing of the past: digital measurements with the shower configurator

Take measurements, enter the details and order – you're done! The new Bohle shower configurator makes life easier. 3D models of shower cubicles and doors, including all the necessary cut-outs and fittings, can be accurately produced quickly and easily to suit individual requirements without any prior knowledge. Then just click – and the appropriate fittings are ordered.

Customers can enter their measurement details directly via the Bohle website. The benefits: The shower configurator immediately shows if all the measurements are complete and where information is still missing. In addition, the appropriate fittings and accessories for the respective application are displayed immediately. A 3D view of the shower in the configurator also shows what the finished product could look like. The program also produces CAD drawings of all glass elements with all cut-outs and holes. The files can then be sent with the order to the glass supplier. The details of the configured products are saved in the customer's online account for possible corrections or further planning.

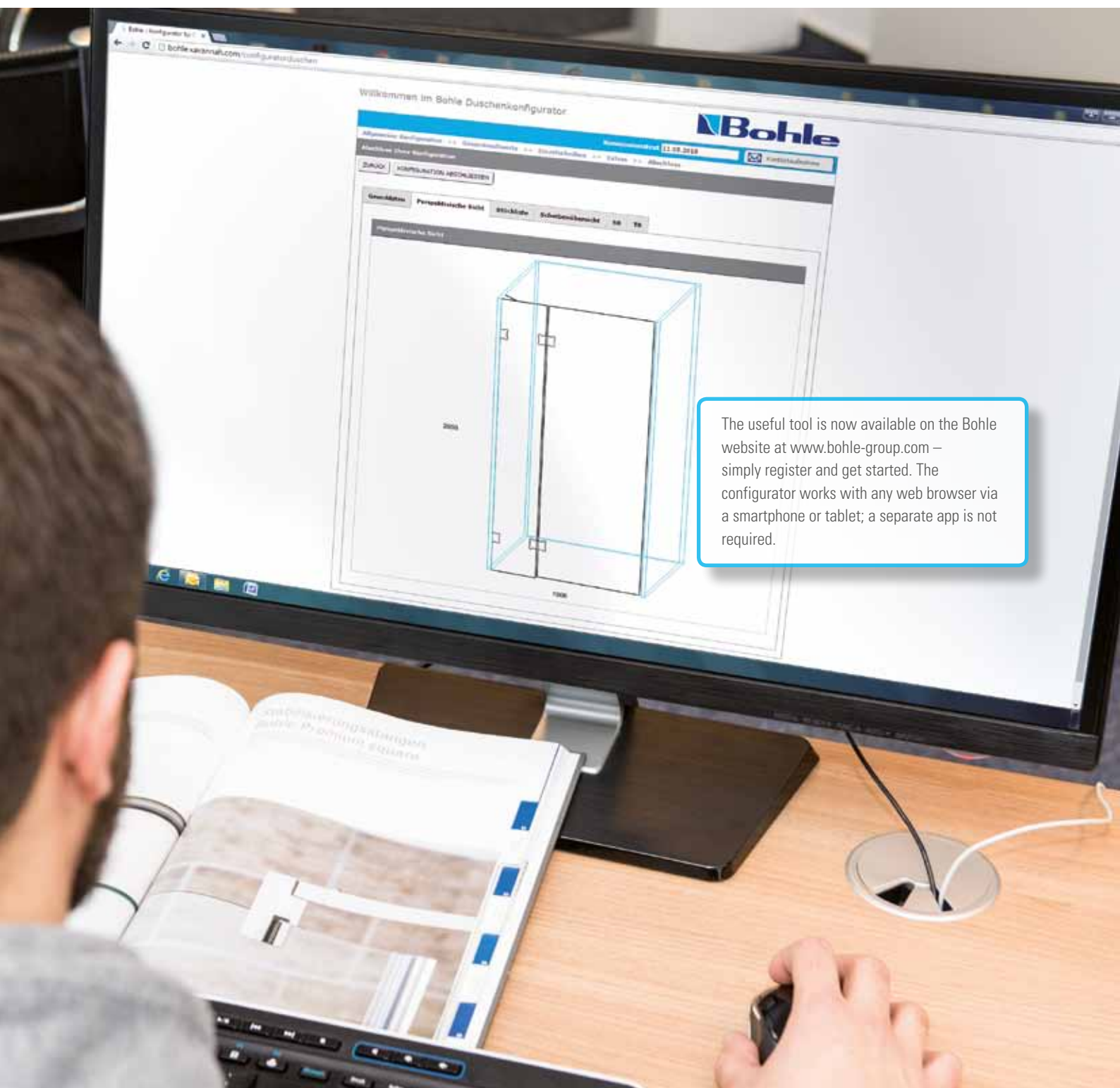

The useful tool is now available on the Bohle website at [www.bohle-group.com](http://www.bohle-group.com) – simply register and get started. The configurator works with any web browser via a smartphone or tablet; a separate app is not required.

# Discover Bohle

The Bohle Group is Europe's leading manufacturer and distributor of tools, machinery and accessories for glass processing and glass finishing. The family business, founded in 1923, is

now represented by over 300 employees at 14 locations in Germany and abroad. Divided into Handling, Glass Cutting, Glass Bonding, Glazing, Tools, Machinery, Fittings and Surface Protection product divisions,

the total product range is precisely tailored to the respective customer groups from trade, industry and retail.

## The Bohle Visitor Centre



In our Bohle visitor centre, located in our Haan headquarters, we present numerous products in a generous exhibition area. Whether fittings, machines, measuring devices or consumables: Next to a shopping area where you can buy products right on the spot, another highlight is a little museum giving an overview of Bohle's 90-year history and exhibiting historical products and documents. Why not visit us – we look forward to welcoming you!

## The Bohle Glass Academy



The Bohle Glass Academy offers you an extensive seminar programme on many glass processing topics. Learn new technologies or broaden your knowledge in well-known sectors.

Our Practical Seminars:

- UV Bonding
- Surface Bonding
- Manual Glass Cutting
- Sliding Door Installation

Each seminar comprises:

- Seminar materials
- Use of materials and tools
- Fabrication of reference samples
- Customised troubleshooting
- Drinks, snacks and lunch
- Bohle Seminar Certificate

For current seminar dates, please visit our website [www.bohle-group.com](http://www.bohle-group.com).

## Planning and Design Manuals



In addition to this catalogue we offer a new edition of our Hardware Catalogue with two practical work aids: A Design Manual and a Planning Manual.

The Design Manual contains all essential product lines on approx. 160 pages, generously illustrated by numerous application images. This catalogue is perfect for choosing a suitable fitting together with your end customer, for example. User-friendly tables guide you to the right products; large images display

the design and the application possibilities of the different products. In addition, intelligent cross-references in the Design Manual facilitate finding the corresponding products in the Planning Manual.

The Planning Manual has more than 700 pages and contains relevant technical data and diagrams. It is meant to serve as a basis to quickly and easily calculate and implement your projects and orders with Bohle products.

# Ways to order at a Glance



## Telephone / Fax

Monday - Thursday      8:00 - 16:30 h  
Friday                      8:00 - 14:00 h

### Prices

Please enquire for your best prices.



## Internet

[www.bohle-group.com](http://www.bohle-group.com)  
24 hours / 365 days

### Prices

Direct display of your individual price conditions for registered customers.

## Shipping

You can order for delivery on a fixed date if desired. If no date is mentioned, an appropriate delivery time will mutually be agreed. The earliest possible delivery week is mentioned on the order confirmation.

## Shipping Costs

You can arrange for your own transport or ask us to arrange transport for you. In this case, transport cost will be charged at cost price. Insurance for any orders is generally NOT included.



# Ordering? And after your order?

---

## Ordering

If you already have a customer number, you can order by phone, fax, e-mail or directly via our Bohle online-shop [www.bohle-group.com](http://www.bohle-group.com). After you have placed your order, you will receive either an order confirmation or a proforma invoice for your acceptance. Please read all order confirmations/proforma invoices carefully, they serve as a double-check for your order. Please communicate any necessary changes/amendments to our confirmation immediately after receipt, otherwise the order details are considered accepted. If you are not a customer yet, we reserve the right to refer you to existing agents/distributors in the respective market.

## Small Orders

Export orders of a value less than € 500.00 are generally not accepted.

For export orders of a value of between € 500.00 and € 1000.00, a processing fee of € 100.00 applies.

## Collecting Goods

Pick-up hours: Monday - Thursday 8:00 am - 3:00 pm  
Friday 8:00 am - 12:00 noon

Collecting goods personally from our warehouse in Haan is possible but can only be organised by contacting the responsible sales person and agreeing a date.

## Transport damages

Transport damages must be claimed to the carrier and confirmed by the same in writing on receipt of the goods. We cannot accept any claims without a carrier's claim confirmation.

Please note our General Sales Conditions found at the back using the key word index!

## Payment

Payment terms have to be agreed upon individually. Payment methods can be T/T transfer, credit card or letter of credit.

# Contents

<b>01 Fittings for Bathrooms</b>	<b>10</b>
Bohle Aqua Shower Door Hinges	12
Bohle Bilbao Shower Door Hinges	14
Bohle Barcelona Shower Door Hinges	15
Bohle Bilbao Select Shower Door Hinges	16
Bohle Barcelona Select Shower Door Hinges	17
Bohle Madrid Shower Door Hinges	18
Bella Shower Door Hinges	20
Bohle Granada Shower Door Hinges	22
Bohle Bilbao Premium Shower Door Hinges	24
Milano Original Shower Door Hinges	25
<b>02 Accessories for bathrooms</b>	<b>26</b>
Shower Door Sealing Strips	27
Reinforcement Bars	29
Handles for Showers	30
U-Profiles for Use in Humid Environments	31
<b>03 Sliding Door Systems</b>	<b>32</b>
Bohle SlideTec optima 50	33
Bohle SlideTec optima 80	37
Bohle SlideTec optima 150	41
Willach Portavant 80 automatic	45
<b>04 Pivot Door Systems</b>	<b>48</b>
Self-closing Patch Fitting	49
Bohle FrameTec Select Frame System	50
Bohle FrameTec Premium Frame System	53
Door Fittings	58



## 05 Accessories for Interior Fit-Out 60

---

Glass Door Handles	61
Glass Door Locks	63
Profiles for Glass Partitions	64
Clamps-On profiles	65
Adhesive Bonding Tapes	66

## 06 Furniture Fittings 67

---





Glass Door Hinge	68
Glass Door Locks	71
Glass Door Handles	73
Showcase Shelf Supports	74
Vitris supra Fittings for Sliding Showcase Doors	75
Point Fixings and Standoffs	82





## 07 Glass Railing Systems 83

---

Bohle EasyMount Top, 1.0 kN top mount	85
Bohle EasyMount Top L, 1.0 kN top mount with extended fixing plate	87
Bohle EasyMount Side, 1.0 kN side mount	89
Bohle EasyMount Side L, 1.0 kN side mount with extended fixing plate	92
Bohle EasyMount <i>Vario</i> Glass Mounting Kits	95
Single Point Fixings	97

# Shower Door Hinges

ShowerTec®	Aqua	Bilbao	Barcelona	Bilbao Select	Barcelona Select
					
Hardware series	Basic	Basic	Basic	Select	Select
Swinging Shower Door Hinge	✓	✓	✓	✓	✓
Shower Door Hinge for one-side opening doors, continuous sealing strip					
Cover for screw holes					
Rise and fall mechanism	✓				
Adjustment of zero position	✓			✓	✓
Drill holes in glass					
Glass cut-out		✓	✓	✓	✓
Glass thickness tempered glass (mm)	6 / 8	8 / 10 / 12	8 / 10 / 12	8 / 10 / 12	8 / 10 / 12
Max. door weight (kg)	35	35	35	35	35
Glass size (mm)	800 x 2200	700 x 2000	700 x 2000	700 x 2000	700 x 2000
Inspection according to DIN 14428					

ShowerTec®	Madrid	Bella	Granada	Bilbao Premium	Milano Original
					
Hardware series	Select	Select	Select	Premium	Premium
Swinging Shower Door Hinge			✓	✓	✓
Shower Door Hinge for one-side opening doors, continuous sealing strip	✓	✓			
Cover for screw holes	✓	✓		✓	✓
Rise and fall mechanism					
Adjustment of zero position			✓	✓	✓
Drill holes in glass	✓	✓			
Glass cut-out			✓	✓	✓
Glass thickness tempered glass (mm)	8 / 10	6 / 8	8 / 10	8 / 10 / 12	8 / 10
Max. door weight (kg)	40	40	35	50	50
Glass size (mm)	1000 x 2000	1000 x 2000	790 x 2000	1000 x 2000	1000 x 2250 (8) 850 x 2250 (10)
Inspection according to DIN 14428					✓





# 01

## Fittings for Bathrooms

### Bohle Aqua Shower Door Hinges

#### Aqua Shower Door Hinges



Shower door profile system in an elegant design

**i** Application glass/wall · Length can be trimmed to size 2200 mm  
 · Hold position both sides 90° · Projection 800 mm · with rise and fall mechanism · Zero position infinitely adjustable · Material Aluminium

**Included in delivery:**

- 1x Wall Profile
- 1x Intermediate profile with brush strips
- 1x Glass profile
- 1x Accessory set incl. end stops

Art. No.	Glass thickness · Finish
BO 5200405	6 mm · anodised aluminium EV1
BO 5200406	6 mm · polished anodised
BO 5200407	8 mm · anodised aluminium EV1
BO 5200408	8 mm · polished anodised

**Please note:**  
 special profiles are also available as accessories for connecting to sidelights.

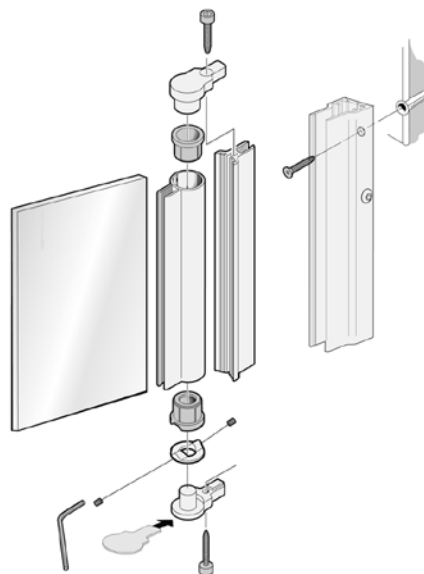
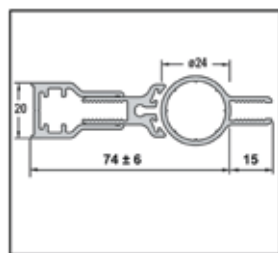

# Bohle Bilbao Shower Door Hinges

## ▶ Bilbao Shower Door Hinge 90° glass/wall One Side Wall Mounted



**i** Mounting One Side Wall Mounted 90° · Door opens both ways 90° · Distance glass/wall 8 mm · Glass thickness 8, 10, 12 mm · Mounting glass-to-wall 90° · Projection max. 700 mm · Door weight per pair max. 35 kg · Door height max. 2000 mm · Return motion automatic ±15° · Material brass

Art. No.	Finish
BO 5211549	chrome-plated
BO 5211550	stainless steel look

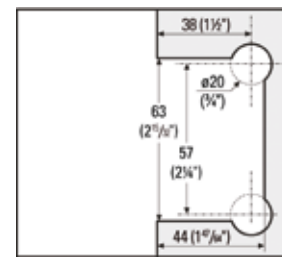
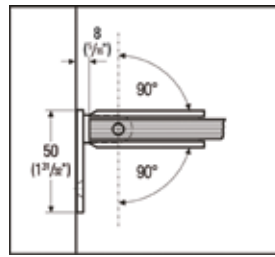
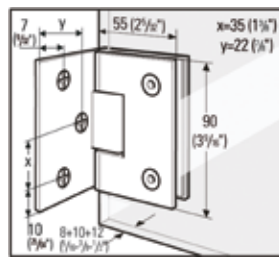

## ▶ Bilbao Shower Door Hinge 180° glass/glass

For mounting doors to a fixed sidelight



**i** Mounting glass/glass 180° · Door opens both ways 90° · Distance glass/glass 4 mm · Glass thickness 8, 10, 12 mm · Projection max. 700 mm · Door weight per pair max. 35 kg · Door height max. 2000 mm · Return motion automatic ±15° · Material brass

Art. No.	Finish
BO 5218210	chrome-plated
BO 5218211	stainless steel look

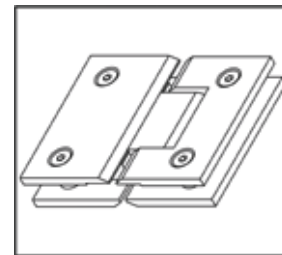
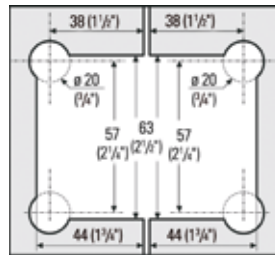
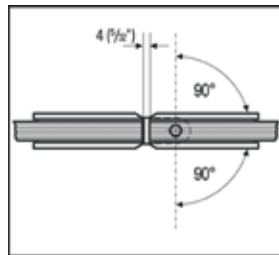
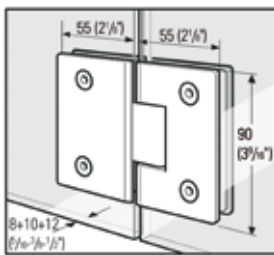

# Bohle Barcelona Shower Door Hinges

## ▶ Barcelona Shower Door Hinge 90° glass/wall One Side Wall Mounted



**i** Mounting One Side Wall Mounted 90° · Door opens both ways 90° · Distance glass/wall 8 mm · Glass thickness 8, 10, 12 mm · Projection max. 700 mm · Door weight per pair max. 35 kg · Door height max. 2000 mm · Return motion automatic ±15° · Material brass

Art. No.	Finish
BO 5218110	chrome-plated
BO 5218111	stainless steel look

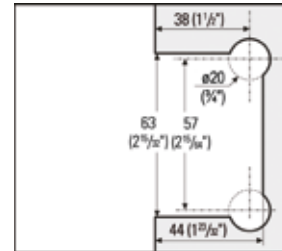
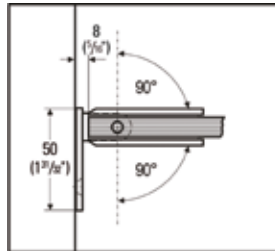
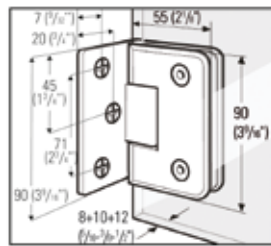

## ▶ Barcelona Shower Door Hinge 180° glass/glass

For mounting doors to a fixed sidelight



**i** Mounting glass/glass aligned 180° · Door opens both ways 90° · Distance glass/glass 4 mm · Glass thickness 8, 10, 12 mm · Projection max. 700 mm · Door weight per pair max. 35 kg · Door height max. 2000 mm · Return motion automatic ±15° · Material brass

Art. No.	Finish
BO 5219210	chrome-plated
BO 5219211	stainless steel look

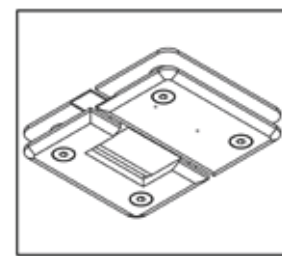
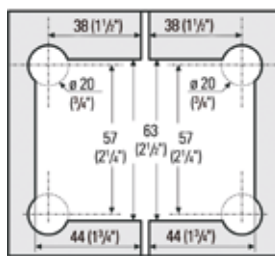
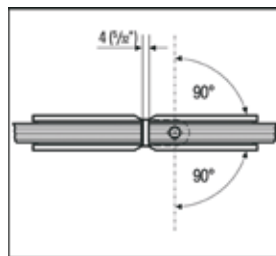
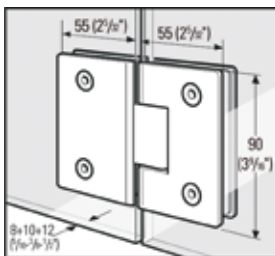

# Bohle Bilbao Select Shower Door Hinges

## Bilbao Select Shower Door Hinge 90° glass / wall One Side Wall Mounted



With adjustable zero position

**i** Mounting One Side Wall Mounted 90° · Door opens both ways 90° · Distance glass/wall 8 mm · Glass thickness 8, 10, 12 mm · Mounting glass-to-wall 90° · Projection max. 700 mm · Return motion to zero position +/- 15° · Door weight per pair max. 35 kg · Door height max. 2000 mm · Adjustable zero position · Material brass

Art. No.	Finish
BO 5211546	chrome-plated
BO 5211547	stainless steel look

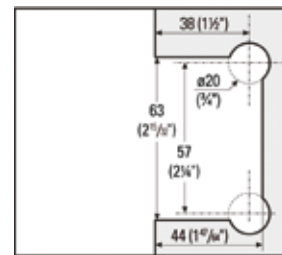
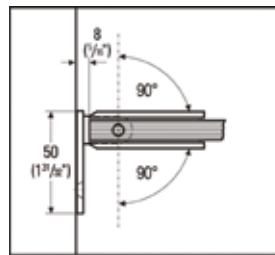
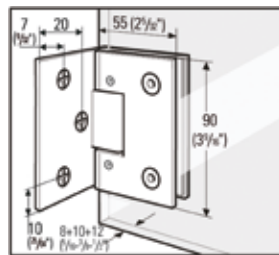

## Bilbao Select Shower Door Hinge 180° (adjustable) glass/glass

With adjustable zero position · For mounting doors to a fixed sidelight

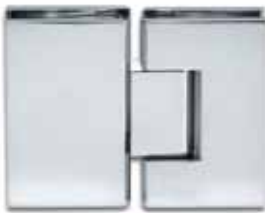

**i** Mounting glass/glass 180° · Door opens both ways 90° · Distance glass/glass 4 mm · Glass thickness 8, 10, 12 mm · Projection max. 700 mm · Door weight per pair max. 35 kg · Door height max. 2000 mm · Material brass · Adjustable zero position · Return motion automatic ±15° · Material brass

Art. No.	Finish
BO 5211716	chrome-plated
BO 5211717	stainless steel look

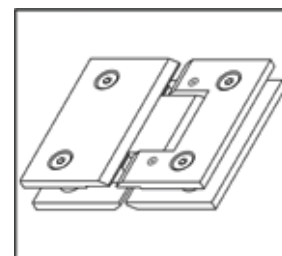
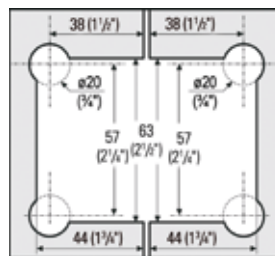
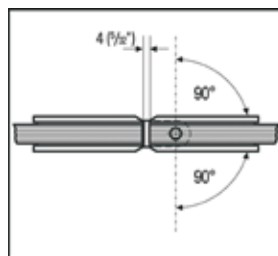
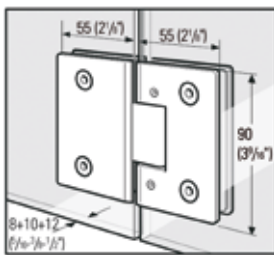

## Bilbao Select Corner Clamp 90° glass/wall

For fixed partitions



**i** Mounting glass/wall 90° · Glass thickness 8, 10, 12 mm · Material brass

Art. No.	Finish
BO 5213140	chrome-plated
BO 5213141	stainless steel look

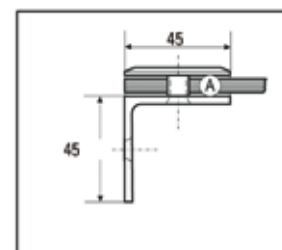
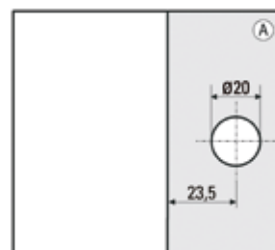
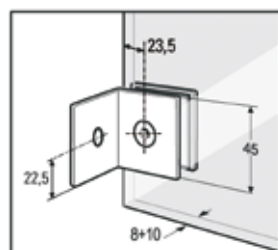



# Bohle Barcelona Select Shower Door Hinges

## Barcelona Select Shower Door Hinge 90° glass / wall One Side Wall Mounted



With adjustable zero position

**i** Mounting One Side Wall Mounted 90° · Door opens both ways 90° · Distance glass/wall 8 mm · Glass thickness 8, 10, 12 mm · Projection max. 700 mm · Door weight per pair max. 35 kg · Door height max. 2000 mm · Adjustable zero position · Return motion automatic ±15° · Material brass

Art. No.	Finish
BO 5219110	chrome-plated
BO 5219111	stainless steel look

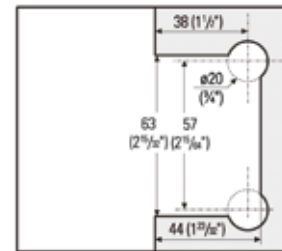
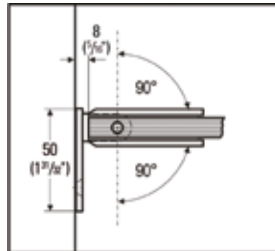
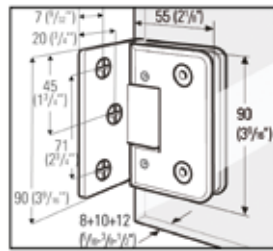

## Barcelona Select Shower Door Hinge 180° (adjustable) glass/glass



With adjustable zero position · For mounting doors to a fixed sidelight

**i** Mounting glass/glass aligned 180° · Door opens both ways 90° · Distance glass/glass 4 mm · Glass thickness 8, 10, 12 mm · Projection max. 700 mm · Door weight per pair max. 35 kg · Door height max. 2000 mm · Adjustable zero position · Return motion automatic ±15° · Material brass

Art. No.	Finish
BO 5219118	chrome-plated
BO 5219119	stainless steel look

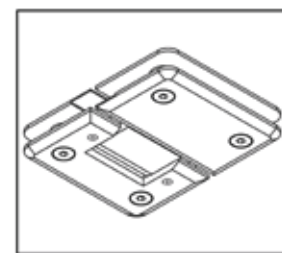
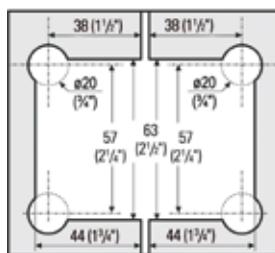
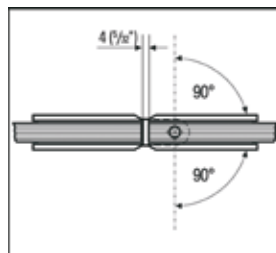
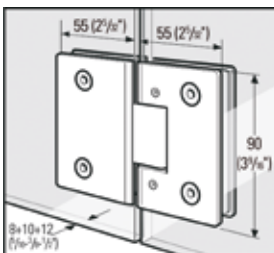

## Barcelona Corner Clamp 90° glass/wall



For fixed partitions

**i** Mounting glass/wall 90° · Distance glass/wall 2 mm · Dimensions 52 x 90 mm · Glass thickness 8, 10, 12 mm · Material brass

Art. No.	Finish
BO 5219080	chrome-plated
BO 5219081	stainless steel look

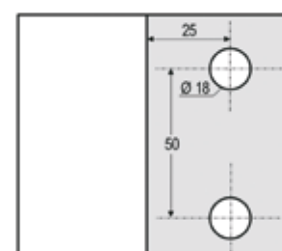
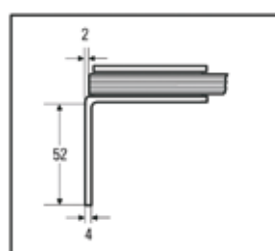
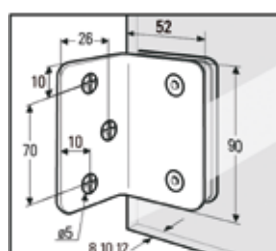

# Bohle Madrid Shower Door Hinges

## ▶ Madrid Shower Door Hinge 90° glass/wall opens outwards



Elongated hole for wall mounting · For use with continuous sealing strips · no glass cut-outs · only bore holes are required · no visible screws · with Cover Cap · Shower Door Hinge

**i** Mounting glass/wall 90° · Door opens outwards · Glass thickness 8, 10 mm · Door size 1000 x 2000 mm · Door weight per pair max. 40 kg · Mounting one side wall mounted · Material brass · Finish shiny chrome-plated

Art. No.

BO 5215430

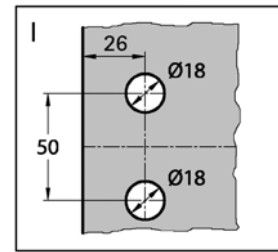
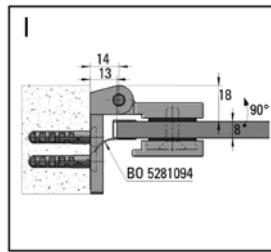
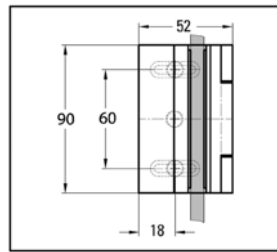
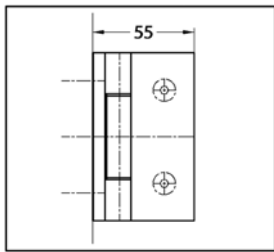

## ▶ Madrid Shower Door Hinge 90° glass/wall opens inwards



Elongated hole for wall mounting · For use with continuous sealing strips · no glass cut-outs · only bore holes are required · no visible screws · with Cover Cap · Shower Door Hinge

**i** Mounting glass/wall 90° · Door opens inwards · Glass thickness 8, 10 mm · Door size 1000 x 2000 mm · Door weight per pair max. 40 kg · Mounting one side wall mounted · Material brass · Finish shiny chrome-plated

Art. No.

BO 5215431

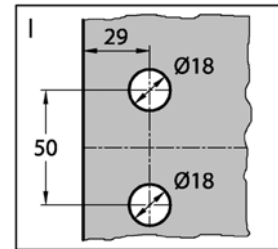
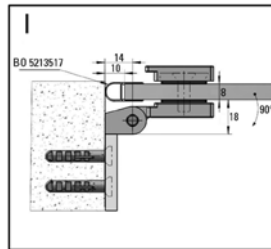
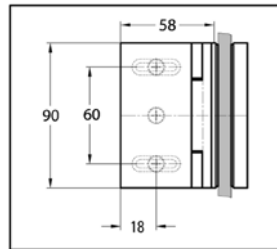
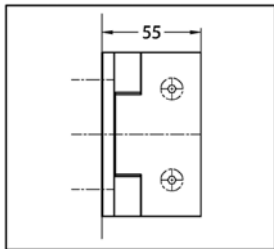

## ▶ Madrid Shower Door Hinge 180° glass/glass



For use with continuous sealing strips · no glass cut-outs · only bore holes are required · no visible screws · with Cover Cap · Shower Door Hinge

**i** Mounting glass/glass 180° · Door opens inwards or outwards · Glass thickness 8, 10 mm · Door size max. 1000 x 2000 mm · Door weight per pair max. 40 kg · Material brass · Finish shiny chrome-plated

Art. No.

BO 5215432

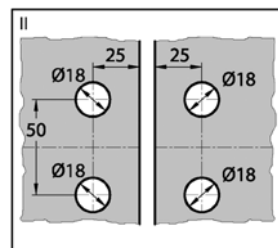
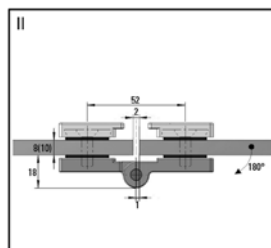
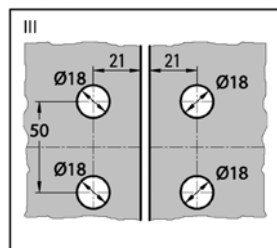
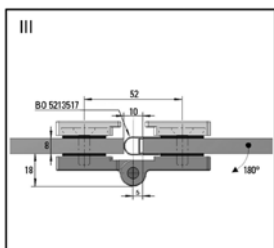

## ▶ Madrid Corner Clamp 90° glass/wall

Elongated hole for wall mounting · no visible screws · with Cover Cap



**i** Mounting glass/wall 90° · Glass thickness 8, 10 mm · Material brass · Finish shiny chrome-plated

Art. No.

BO 5215433

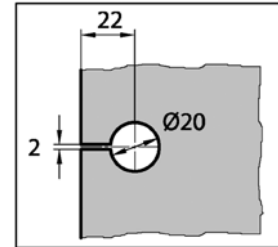
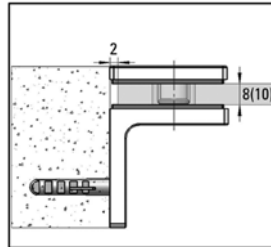
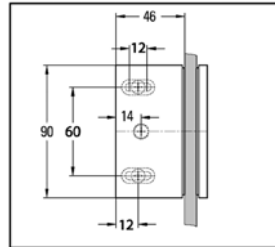

## ▶ Madrid Corner Clamp 90° glass/glass

no visible screws · with Cover Cap



**i** Mounting glass/glass 90° · Glass thickness 8, 10 mm · Material brass · Finish shiny chrome-plated

Art. No.

BO 5215434

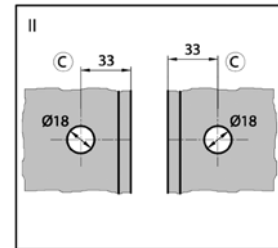
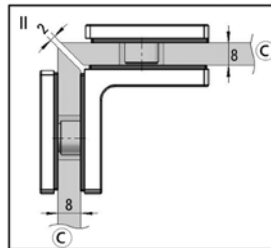
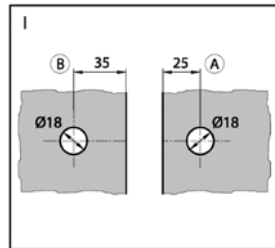
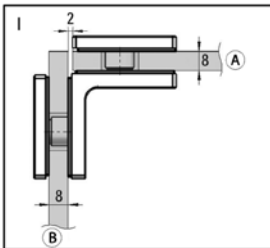

# Bella Shower Door Hinges

## Bella Shower Door Hinge 90° glass/wall opens outwards



Elongated hole for wall mounting · With cover plate for screw holes · For use with continuous sealing strips · no glass cut-outs - only bore holes are required

**i** Mounting glass/wall 90° · Door opens outwards · Glass thickness 6, 8 mm · Door size max. 1000 x 2000 mm · Door weight per pair max. 40 kg · Mounting one side wall mounted · Material brass

Art. No.	Finish
BK 8101231	chrome-plated

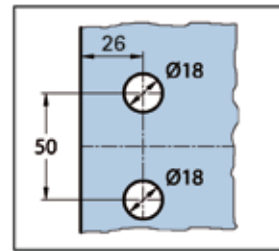
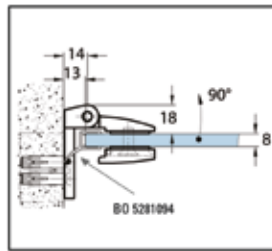
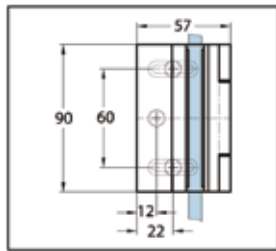
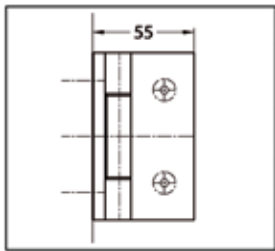

## Bella Shower Door Hinge 90° opens inwards



Elongated hole for wall mounting · With cover plate for screw holes · For use with continuous sealing strips · no glass cut-outs - only bore holes are required

**i** Mounting glass/wall 90° · Door opens inwards · Glass thickness 6, 8 mm · Door size max. 1000 x 2000 mm · Door weight per pair max. 40 kg · Mounting one side wall mounted · Material brass

Art. No.	Finish
BK 8101331	chrome-plated

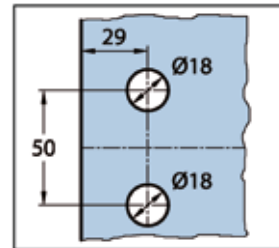
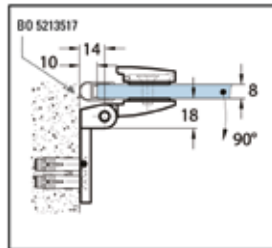
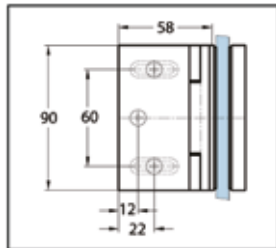
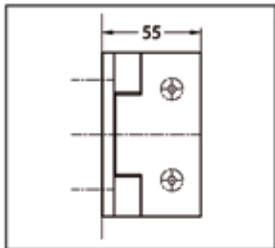

## Bella Shower Door Hinge 180°



For use with continuous sealing strips · no glass cut-outs - only bore holes are required

**i** Mounting glass/glass 180° · Door opens inwards or outwards · Glass thickness 6, 8 mm · Door size max. 1000 x 2000 mm · Door weight per pair max. 40 kg · Material brass

Art. No.	Finish
BK 8103031	chrome-plated

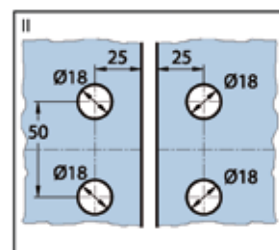
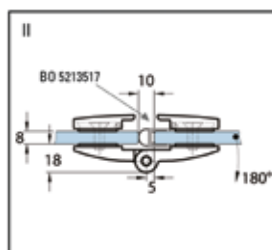
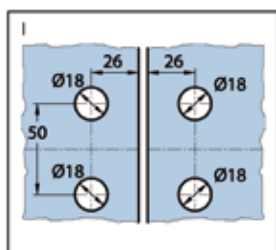
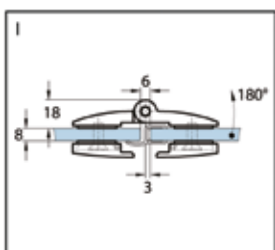

## Bella Corner Clamp 90° glass/wall



Elongated hole for wall mounting · With cover plate for screw holes

**i** Mounting glass/wall 90° · Glass thickness 6, 8 mm · Material brass

Art. No.	Finish
BK 8108031	chrome-plated

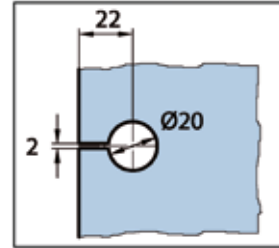
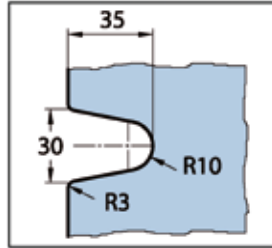
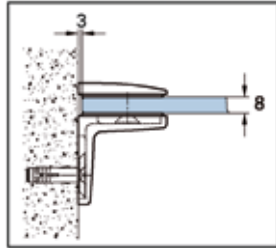
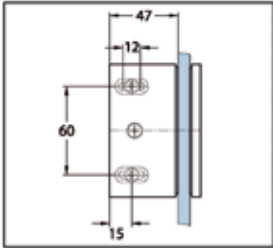

## Bella Corner Clamp 90° glass/glass



**i** Mounting glass/glass 90° · Glass thickness 6, 8 mm · Size 45 (47) x 90 mm · Material brass

Art. No.	Finish
BK 8108331	chrome-plated

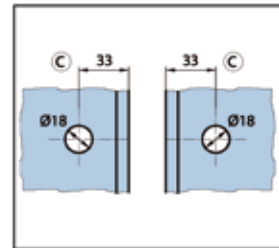
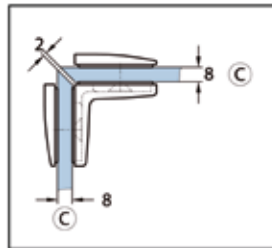
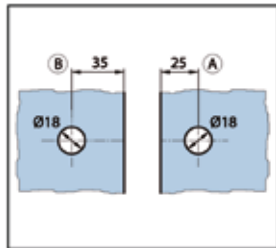
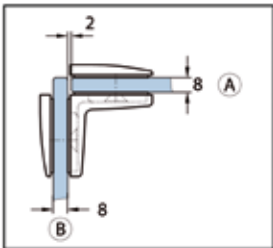

# Bohle Granada Shower Door Hinges

## ▶ Granada Shower Door Hinge 90° glass/wall Both Sides Wall Mounted



**i** Mounting both sides wall mounted 90° · Door opens both ways 90° · Glass thickness 8, 10 mm · Distance glass/wall 6 mm · Door size max. 790 x 2000 mm · Door weight per pair max. 35 kg · Zero position adjustable · Return motion automatic ~ ±15° · Material brass

Art. No.	Finish
BO 5214050	chrome-plated
BO 5214045	stainless steel look

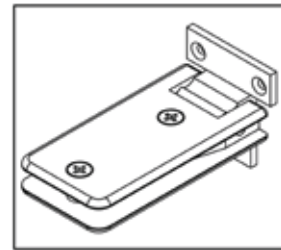
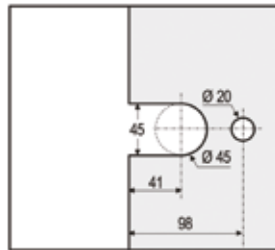
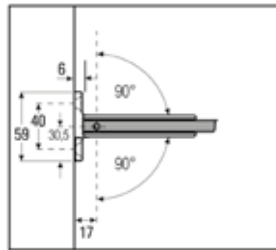
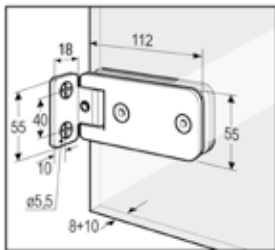

## ▶ Granada Shower Door Hinge 90° glass/wall One Side Wall Mounted



**i** Mounting one side wall mounted 90° · Door opens both ways 90° · Glass thickness 8, 10 mm · Distance glass/wall 6 mm · Door size max. 790 x 2000 mm · Door weight per pair max. 35 kg · Zero position adjustable · Return motion automatic ~ ±15° · Material brass

Art. No.	Finish
BO 5214058	chrome-plated
BO 5214046	stainless steel look

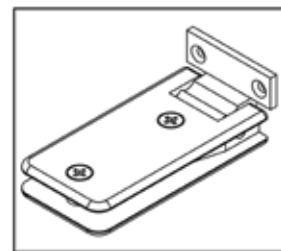
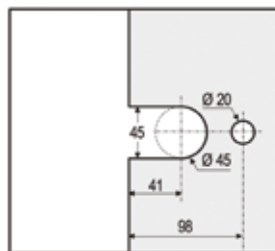
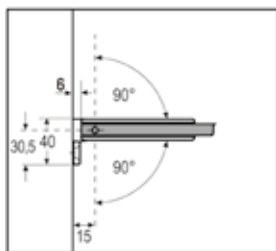
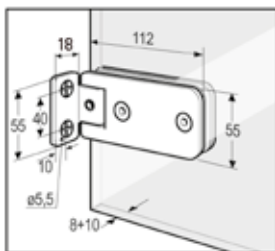

## ▶ Granada Shower Door Hinge 180° glass/glass

For mounting doors to a fixed sidelight



**i** Mounting glass/glass aligned 180° · Door opens both ways 90° · Glass thickness 8, 10 mm · Distance glass/glass 3 mm · Door size max. 790 x 2000 mm · Door weight per pair max. 35 kg · Zero position adjustable · Return motion automatic ~±15° · Material brass

Art. No.	Finish
BO 5214052	chrome-plated
BO 5214047	stainless steel look

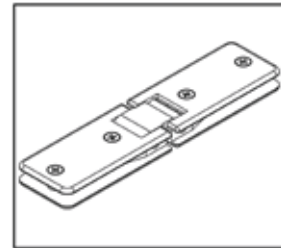
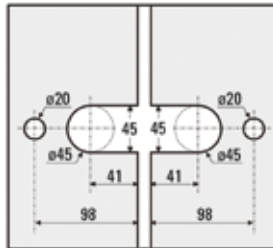
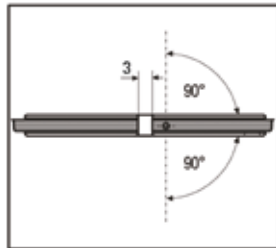
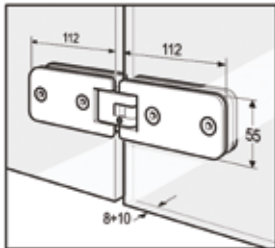

## ▶ Corner Clamp 90° glass/wall

Screw and screw cover are included



**i** Mounting glass/wall 90° · Glass thickness 8, 10 mm · Dimensions 45 x 45 mm · Hole height for wall plate inside 5.5 mm · Material brass

Art. No.	Finish
BO 5213116	chrome-plated
BO 5213115	stainless steel look

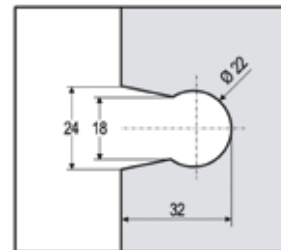
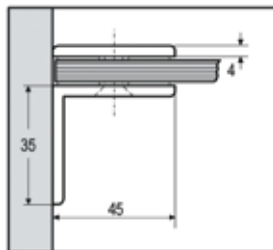
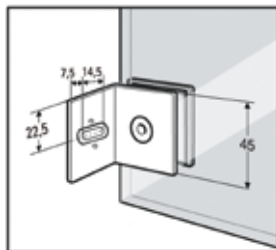

# Bohle Bilbao Premium Shower Door Hinges

## ▶ Bilbao Premium Shower Door Hinge 90° (adjustable) One Side Wall Mounted 50 kg



With adjustable zero position · with elongated hole and cover plates for screw holes

**i** Door weight per pair max. 50 kg · Mounting one side wall mounted 90° glass / wall · Glass thickness 8, 10, 12 mm · Projection max. 1000 mm · Door height max. 2000 mm · Adjustable zero position infinitely adjustable · Return motion automatic +/- 15° · Material brass

Art. No.	Finish
BO 5211563	chrome-plated
BO 5211564	stainless steel look

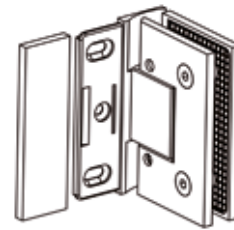
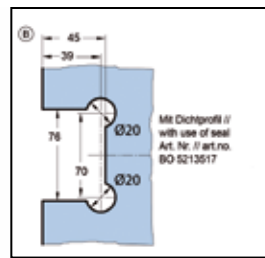
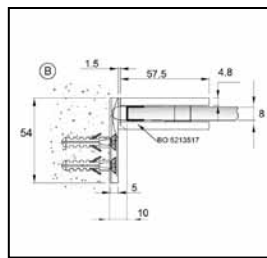
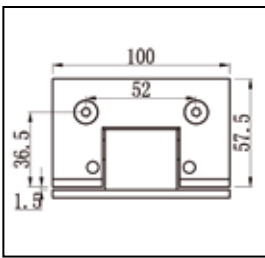

## ▶ Bilbao Premium Shower Door Hinge 180° (adjustable) glass/glass mounting 50 kg

With adjustable zero position



**i** Door weight per pair max. 50 kg · Mounting glass/glass 180° · Door opens both ways 90° · Glass thickness 8, 10, 12 mm · Projection max. 1000 mm · Door height max. 2000 mm · Adjustable zero position infinitely adjustable · Return motion automatic +/- 15° · Material brass

Art. No.	Finish
BO 5211565	chrome-plated
BO 5211566	stainless steel look

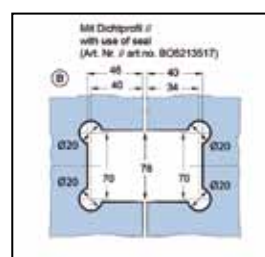
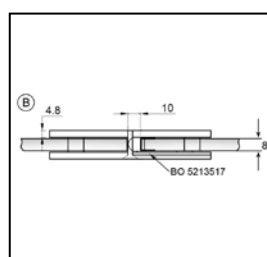
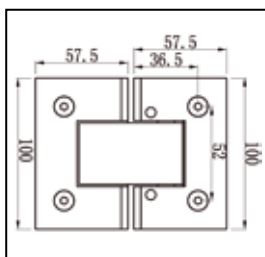

## ▶ Bilbao Premium Corner Clamp glass/wall 90°

with elongated hole and cover plates for screw holes



**i** Mounting glass/wall 90° · Glass thickness 8, 10, 12 mm · Material brass · suitable for Shower Door Hinges 50 kg

Art. No.	Finish
BO 5211567	chrome-plated
BO 5211568	stainless steel look

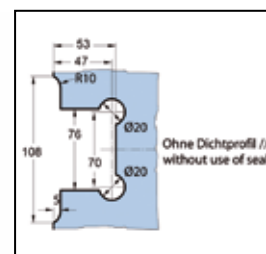
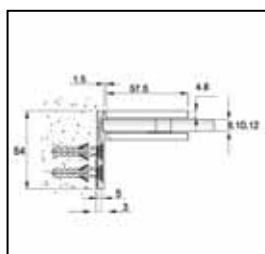
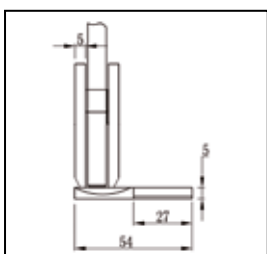
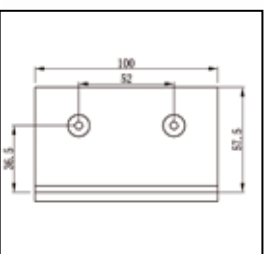



# Milano Original Shower Door Hinges

## Milano Original Shower Door Hinge 90° glass/wall Elongated Hole for Wall Mounting



Supplied without mounting hardware · Elongated hole for wall mounting · With cover plate for screw holes

**i** Mounting glass/wall 90° · Glass thickness 8, 10 mm · Adjustable zero position infinitely adjustable · Door size (8 mm) max. 1000 x 2250 mm · Door size (10 mm) max. 850 x 2250 mm · Door weight per pair max. 50 kg · Mounting one side wall mounted · Material brass

Art. No.	Finish
BK 0781231	chrome-plated
BK 0781255	stainless steel look

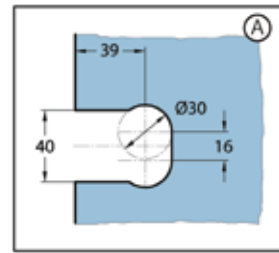
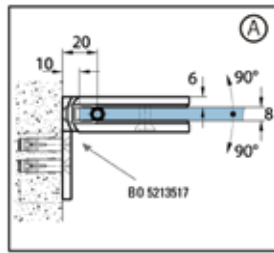
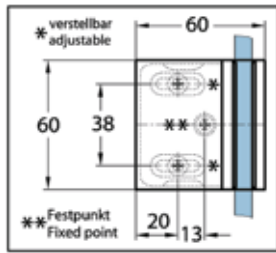
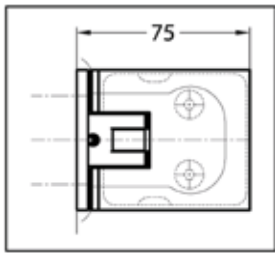

## Milano Original Shower Door Hinge 180° glass/glass aligned



**i** Mounting glass/glass 180° · Glass thickness 8, 10 mm · Adjustable zero position infinitely adjustable · Door size (8 mm) max. 1000 x 2250 mm · Door size (10 mm) max. 850 x 2250 mm · Door weight per pair max. 50 kg · Material brass

Art. No.	Finish
BK 0783031	chrome-plated
BK 0783055	stainless steel look

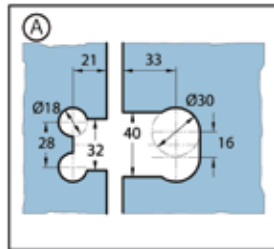
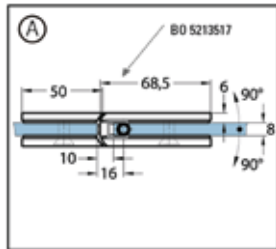
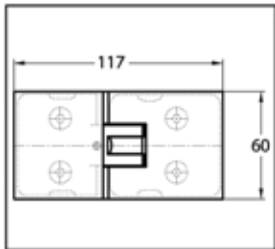

## Milano Original / Premium Corner Clamp 90° glass/wall Elongated Hole for Wall Mounting



Supplied without mounting hardware · Elongated hole for wall mounting · With cover plate for screw holes

**i** Mounting glass/wall 90° · Glass thickness 8, 10 mm · Material brass

Art. No.	Finish
BK 0749031	chrome-plated
BK 0749055	stainless steel look

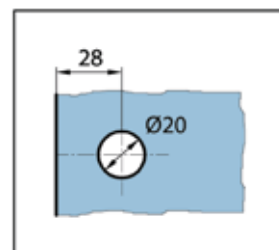
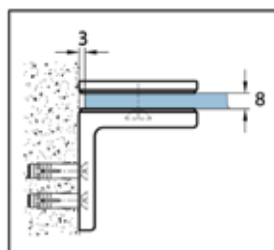
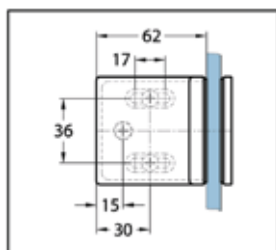
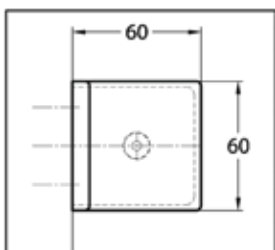



Sealing Strip with Magnetic Profile

# 02

## Accessories for Bathrooms

### Shower Door Sealing Strips

#### Water Deflector Glass thickness 6 - 8 mm

With lower sealing lip and 8 mm water deflector at the bottom

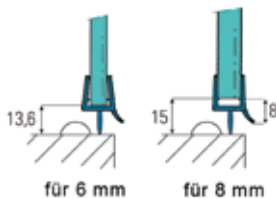

**i** Glass thickness 6 + 8 mm · Length 2160 mm · Material Plastic · Max. allowable continuous temperature: 60°C

Art. No.

BO 5213490

#### Water Deflector Glass thickness 10 - 12 mm

With lower sealing lip and 8 mm water deflector at the bottom

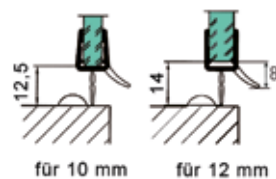

**i** Glass thickness 10 + 12 mm · Length 2160 mm · Material Plastic · Max. allowable continuous temperature: 60°C

Art. No.

BO 5281091

#### Sealing Strip Glass thickness 6 - 8 mm with bellows

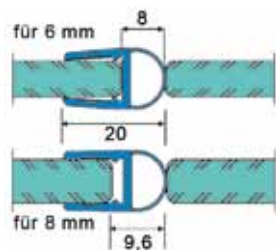

**i** With bellows · Glass thickness 6 + 8 mm · Length 2160 mm · Material Plastic · Max. allowable continuous temperature: 60°C

Art. No.

BO 5213517

#### Sealing Strip Glass thickness 10 - 12 mm with bellows

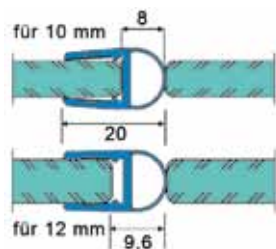

**i** With bellows · Glass thickness 10 + 12 mm · Length 2160 mm · Material Plastic · Max. allowable continuous temperature: 60°C

Art. No.

BO 5281020

#### Sealing Strip Glass thickness 6 - 8 mm with Magnetic Profile for 90° corner access

For 90° corner access

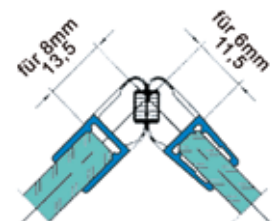

**i** With magnetic profile · Glass thickness 6 + 8 mm · Length 2160 mm · Material Plastic · Max. allowable continuous temperature: 60°C

Art. No.

BO 5213529

▶ Sealing Strip Glass thickness 6 - 8 mm with Magnetic Profile Door 180° Aligned

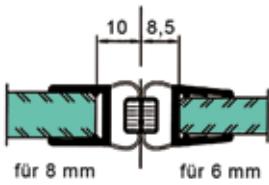

❗ With magnetic profile · Door aligned 180° · Glass thickness 6 + 8 mm · Length 2160 mm · Material Plastic · Max. allowable continuous temperature: 60°C

Art. No.	
BO 5213530	

▶ Shower Sealing Strip Glass thickness 8 - 10 mm Door aligned 180°

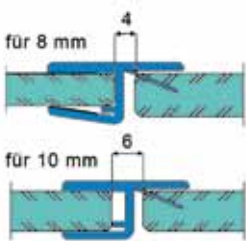

Seals between fixed sidelight and door

❗ Glass thickness 8 + 10 mm · Length 2160 mm · Door aligned 180° · Material Plastic · Max. allowable continuous temperature: 60°C

Art. No.	
BO 5281018	

▶ Lateral Sealing Strip Glass thickness 8 mm with Sealing Lip

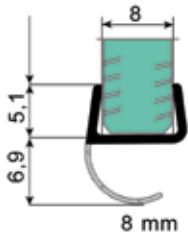

With sealing lip · seals between glass edge and wall

❗ Glass thickness 8 mm · Length 2160 mm · Material Plastic · Max. allowable continuous temperature: 60°C

Art. No.	
BO 5213492	

▶ Water Deflector Glass thickness 6 - 8 mm with bellows 13 mm

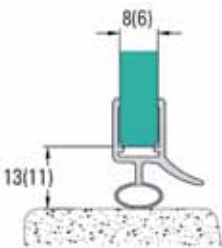

Bellows 13 mm · Water deflector bottom 8 mm

❗ Glass thickness 6 + 8 mm · Length 2010 mm · Material Plastic · Max. allowable continuous temperature: 60°C

Art. No.	
BO 5213494	

▶ Sealing Strip self-adhesive Glass thickness 8 - 12 mm



❗ Version Sealing Strip · Length 2500 mm · Glass thickness 8 - 12 mm · Finish transparent · Max. allowable continuous temperature: 60°C

Art. No.	
BK 69230	

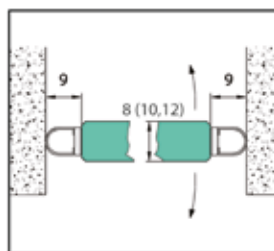
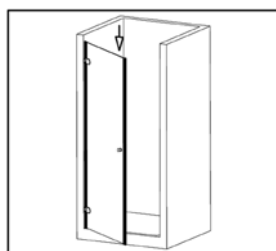

# Reinforcement Bars

## ▶ Bohle Basic Reinforcement Bar round glass/wall

Bar can be trimmed to size · Wall connector adjustable



ⓘ ø 12 mm · Glass thickness 8 - 10 mm · Finish chrome-plated · Material brass

Art. No.	Length
BO 5420065	1210 mm

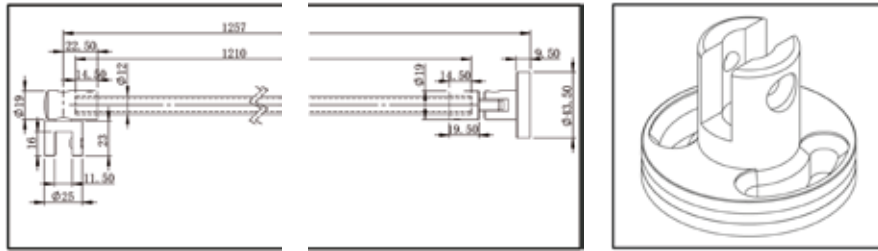

## ▶ Bohle Basic Telescopic Reinforcement Bar round glass/wall 90°

Length adjustable



ⓘ Glass thickness 6 - 10 mm · Finish chrome-plated

Art. No.	L = length
BO 5420211	820 - 1000 mm
BO 5420215	1000 - 1150 mm

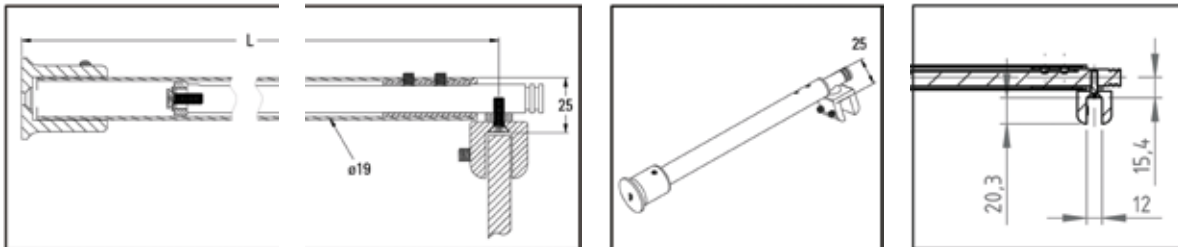

## ▶ Bohle Basic Reinforcement Bar square glass/wall straight



ⓘ Length 1000 mm · Glass thickness 6 - 10 mm · Material stainless steel

Included in delivery:  
1x Reinforcement Bar  
1x Glass Connector / End Piece  
1x Wall Connector

Art. No.	Finish
BO 5420240	matt brushed
BO 5420241	mirror polished

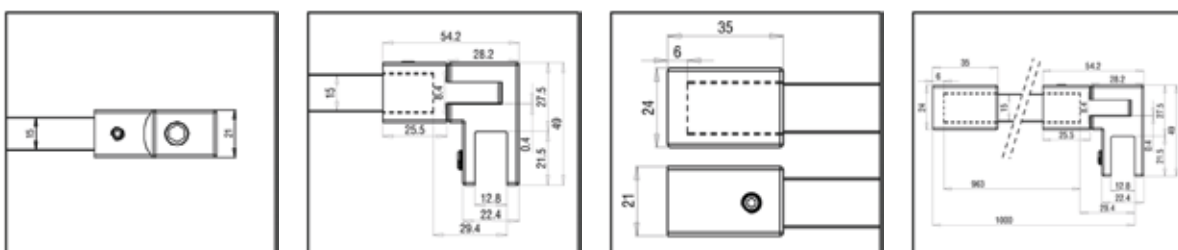

# Handles for Showers

## ▶ Shower Door Knob, Handle length 30 mm

Double-sided



❗  $\varnothing$  32 mm · Handle length 30 mm · Drill hole in glass  $\varnothing$  10 mm · Glass thickness 6 - 10 mm · Packaging unit 1 set

Art. No.	Finish · Material
BO 5213705	chrome-plated · brass
BO 5213706	stainless steel look · brass

## ▶ Shower Door Knob, Handle length 30 mm

Double-sided



❗  $\varnothing$  30 mm · Handle length 30 mm · Drill hole in glass  $\varnothing$  10 mm · Glass thickness 6 - 10 mm · Material brass, chrome-plated · Packaging unit 1 set

Art. No.	Finish
BO 5213722	chrome-plated

## ▶ Shower Door Knob

Double-sided



❗ Drill hole in glass  $\varnothing$  12 mm · Glass thickness 6 - 8 mm · Packaging unit 1 set

Art. No.	Diameter · Handle length · Material · Finish
BO 5206702	35 mm · 35 mm · brass · chrome-plated
BO 5206802	50 mm · 40 mm · brass · chrome-plated

## ▶ Shower Door Knob, Handle length 30 mm



❗ Length 30 mm · Width 30 mm · Height 30 mm · Drill hole in glass  $\varnothing$  12 mm · Shape both sides square-cut · Glass thickness 8 + 10 mm

Art. No.	Finish
BK 0503031	chrome-plated
BK 0503055	stainless steel look

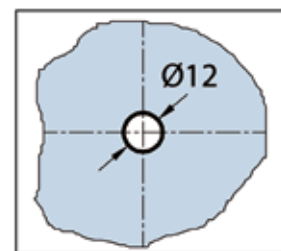
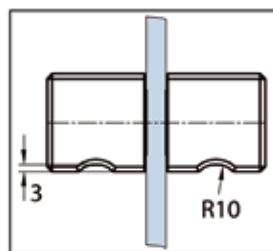
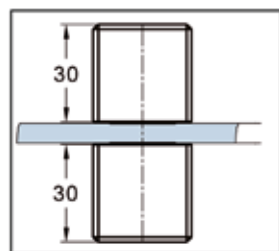
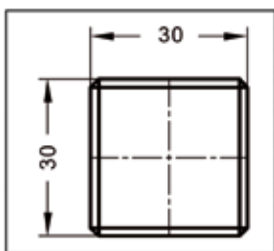

# U-Profiles for Use in Humid Environments

## ▶ U-Channels 15 x 15 x 15 x 2 mm

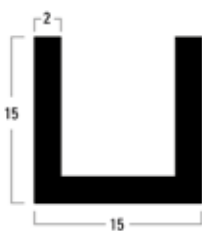

For framing glass panels, for edge protection or for all-glass constructions and diverse applications · aluminium, minimum surface roughness, exquisite-looking finish

**i** Length 5000 mm

Art. No.	Finish
BO 5201571	anodised E6/EV1
BO 5201573	stainless steel look
BO 5201572	shiny chrome-plated

## ▶ U-Channels 20 x 20 x 20 x 2 mm



For framing glass panels, for edge protection or for all-glass constructions and diverse applications · aluminium, minimum surface roughness, exquisite-looking finish

**i** Length 5000 mm

Art. No.	Finish
BO 5201591	anodised E6/EV1
BO 5201593	stainless steel look
BO 5201592	shiny chrome-plated

## ▶ U-Channels 20 x 17 x 20 x 1.5 mm

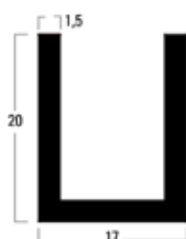

For framing glass panels, for edge protection or for all-glass constructions and diverse applications · aluminium, minimum surface roughness, exquisite-looking finish

**i** Length 5000 mm





Art. No.	Finish
BO 5201581	anodised E6/EV1
BO 5201583	stainless steel look
BO 5201582	shiny chrome-plated

## Note:

For further U-profiles, please see page 64.

# 03

## Sliding Door Systems

	Bohle SlideTec optima 50	Bohle SlideTec optima 80	Bohle SlideTec optima 150	Portavant 80 automatic
				
Max. sliding door weight per door (kg)	50	80	150	80
Wall mounting	✓	✓	✓	✓
Ceiling mounting	✓	✓	✓	✓
Ceiling mounting with sidelight	✓	✓	✓	✓
Flush ceiling mounting			✓	
Flush ceiling mounting with sidelight			✓	
Glass type	Tempered glass: 8 / 10 mm	Tempered glass: 8/10 mm LSG*: 8.76 / 10.76 mm	Tempered glass: 8/10/12 mm LSG*: 8.76/10.76/12.76 mm	Tempered glass: 8/10/12 mm LSG*: 8.76/10.76/12.76 mm
Damping mechanism both sides	✓	✓	✓	
No glass processing	✓	✓	✓ (Tempered glass)	✓
Profile height (mm)	57	57	70	70
Min. distance of glass door to the wall (mm)	18	18	21	25
Single and multiple doors	✓	✓	✓	✓
Two door Synchro			✓	✓
EV1	✓	✓	✓	✓
Stainless steel effect	✓	✓	✓	✓

\* LSG from 2x Tempered glass





# Bohle SlideTec optima 50

## SlideTec optima 50 Wall Mounting single door with damping mechanism



The minimum door width for using a damping mechanism is 800 mm.

**i** Mounting wall mounting · Version single door · Door weight max. 50 kg · Glass thickness tempered glass 8 + 10 mm · Glass processing none · Material aluminium · profile pre-drilled · Profile length 2000 mm

### Included in delivery:

- 2x Carriages
- 2x End stops
- 1x Top track, wall mounting
- 1x Clip-on cover incl. fixing material
- 1x Standard bottom guide
- 2x Damping mechanism, in opening and closing direction (without glass processing)
- 1x Release bolt
- 2x End caps, lateral

Art. No.	Finish
BO 5101681	anodised aluminium EV1
BO 5101682	stainless steel look

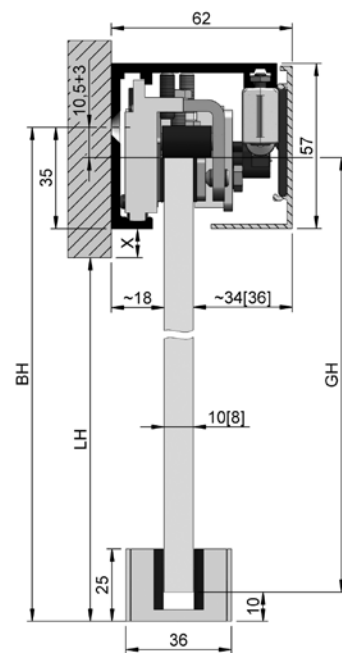

GH = glass height  
LH = clear height  
BH = drill height



## SlideTec optima 50 Ceiling Mounting single door with damping mechanism



Please order cover caps separately. · The minimum door width for using a damping mechanism is 800 mm.

**i** Mounting ceiling mounting · Version single door · Door weight max. 50 kg · Glass thickness tempered glass 8 + 10 mm · Glass processing none · Material aluminium · profile pre-drilled · Profile length 2000 mm

### Included in delivery:

- 2x Carriages
- 2x End stops
- 1x Top track ceiling mounting
- 1x Clip-on cover incl. fixing material
- 1x Standard bottom guide
- 2x Damping mechanism, in opening and closing direction (without glass processing)
- 1x Release bolt

Art. No.	Finish
BO 5101685	anodised aluminium EV1
BO 5101686	stainless steel look

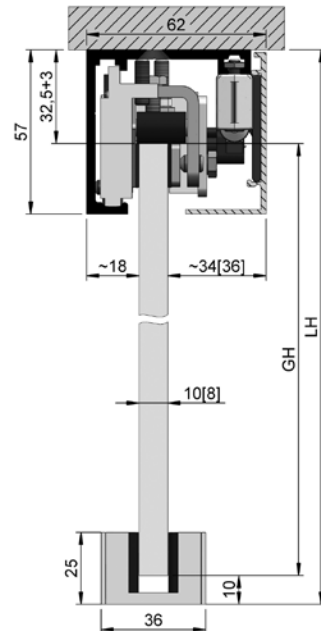

GH = glass height  
LH = clear height



## SlideTec optima 50 Ceiling Mounting with Fixed Sidelight single door with damping mechanism



When fixing the T-cover, please use all clamps. · Please order cover caps separately. · The minimum door width for using a damping mechanism is 800 mm. · U-profile for fixed glass needs to be ordered separately

**i** Mounting ceiling mounting · Version single door · Door weight max. 50 kg · Glass thickness tempered glass 8 + 10 mm · Glass processing none · Material aluminium · profile pre-drilled · Profile length 2000 mm

### Included in delivery:

- 2x Carriages
- 2x End stops
- 1x Running track ceiling mounting with fixed sidelight
- 1x Clip-on cover incl. fixing material
- 1x Standard bottom guide
- 1x Cover profile with fixing clips
- 2x Damping mechanism, in opening and closing direction (without glass processing)
- 1x Release bolt

Art. No.	Finish
BO 5101689	anodised aluminium EV1
BO 5101690	stainless steel look

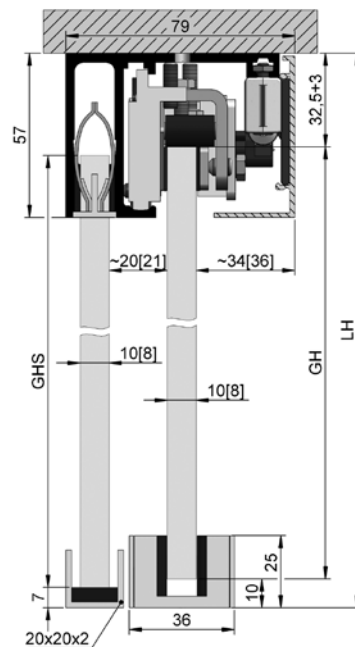

GH = glass height  
 LH = clear height  
 GHS = glass height of fixed sidelight



# Bohle SlideTec optima 80

## SlideTec optima 80 Ceiling Mounting with damping mechanism



Please note: · The minimum door width for using a damping mechanism is 800 mm. · Please order cover caps separately

**i** Mounting ceiling mounting · Version single door · Door weight max. 80 kg · Glass thickness tempered glass 8 + 10 mm · Glass thickness laminated safety glass consisting of tempered glass/PVB/tempered glass 8.76 - 10.76 mm · Glass processing none · Material aluminium · profile pre-drilled

### Included in delivery:

- 2x Roller units incl. clamps
- 2x Stoppers
- 1x Running track, ceiling mounting incl. clip-on cover and fixing material
- 1x Bottom guide standard
- 2x Damping mechanism, in opening and closing direction (without glass processing)
- 1x Release bolt

Art. No.	Length · Finish
BO 5101521N	2000 mm · anodised aluminium EV1
BO 5101523N	2500 mm · anodised aluminium EV1
BO 5101525N	3000 mm · anodised aluminium EV1
BO 5101527N	2000 mm · stainless steel look
BO 5101529N	2500 mm · stainless steel look
BO 5101531N	3000 mm · stainless steel look

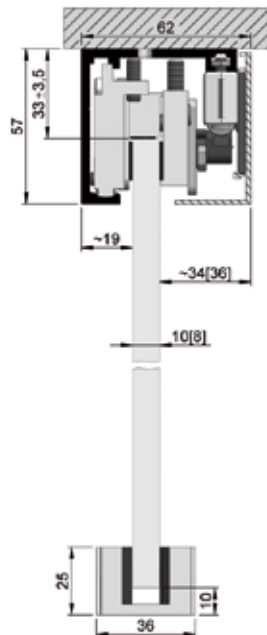



## SlideTec optima 80 Wall Mounting with damping mechanism



Please note: · The minimum door width for using a damping mechanism is 800 mm.

**i** Mounting wall mounting · Version single door · Door weight max. 80 kg · Glass thickness tempered glass 8 + 10 mm · Glass thickness laminated safety glass consisting of tempered glass/PVB/tempered glass 8.76 - 10.76 mm · Glass processing none · Material aluminium · profile pre-drilled

### Included in delivery:

- 2x Roller units incl. clamps
- 2x Stoppers
- 1x Running track, wall mounting incl.
- 1x Bottom guide standard
- 2x Damping mechanism, in opening and closing direction (without glass processing)
- 2x End caps, lateral
- 1x Release bolt

Art. No.	Length · Finish
BO 5101522N	2000 mm · anodised aluminium EV1
BO 5101524N	2500 mm · anodised aluminium EV1
BO 5101526N	3000 mm · anodised aluminium EV1
BO 5101528N	2000 mm · stainless steel look
BO 5101530N	2500 mm · stainless steel look
BO 5101532N	3000 mm · stainless steel look

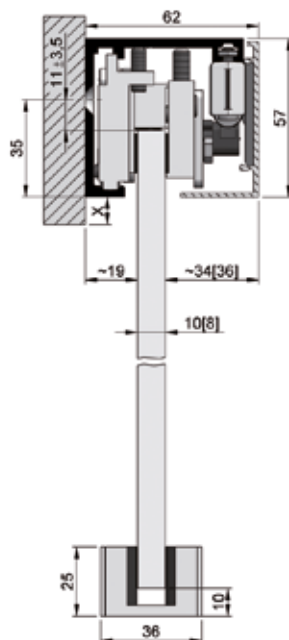



## SlideTec optima 80 Ceiling Mounting with Fixed Sidelight with damping mechanism



- Please note:
- The minimum door width for using a damping mechanism is 800 mm.
  - When fixing the T-cover, please use all clamps.
  - Please order cover caps separately.
  - U-profile for fixed glass needs to be ordered separately

**i** Mounting ceiling mounting · Version single door with fixed sidelight · Door weight max. 80 kg · Glass thickness tempered glass 8 + 10 mm · Glass thickness laminated safety glass consisting of tempered glass/PVB/tempered glass 8.76 - 10.76 mm · Glass processing none · Material aluminium · profile pre-drilled

### Included in delivery:

- 2x Roller units incl. clamps
- 2x Stoppers
- 1x Running track, ceiling mounting incl. clip-on cover and fixing material
- 1x Cover profile with fixing clips
- 1x Bottom guide standard
- 2x Damping mechanism, in opening and closing direction (without glass processing)
- 1x Release bolt

Art. No.	Length · Finish
BO 5101533N	2000 mm · anodised aluminium EV1
BO 5101534N	2500 mm · anodised aluminium EV1
BO 5101535N	3000 mm · anodised aluminium EV1
BO 5101536N	2000 mm · stainless steel look
BO 5101537N	2500 mm · stainless steel look
BO 5101538N	3000 mm · stainless steel look

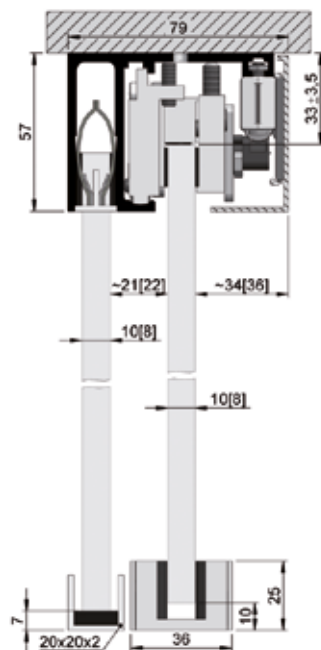





# Bohle SlideTec optima 150

## SlideTec optima 150 Ceiling Mounting single door



Please note: Please order cover caps separately.

**i** Mounting ceiling mounting · Version single door · Door weight max. 150 kg · Glass thickness tempered glass 8 - 12 mm · Glass thickness laminated safety glass consisting of tempered glass/PVB/tempered glass 8.76 - 12.76 mm · Glass processing tempered glass none · Glass processing laminated safety glass yes · Material aluminium · profile pre-drilled

### Included in delivery:

- 2x Carriages
- 2x End stops
- 1x Top track ceiling mounting
- 1x Cover incl. fixing
- 1x Bottom guide (when using 12.76 mm laminated safety glass, please request special guide)

Art. No.	Length · Finish
BO 5101551N	2000 mm · anodised aluminium EV1
BO 5101553N	2500 mm · anodised aluminium EV1
BO 5101555N	3000 mm · anodised aluminium EV1
BO 5101557N	2000 mm · stainless steel look
BO 5101559N	2500 mm · stainless steel look
BO 5101561N	3000 mm · stainless steel look

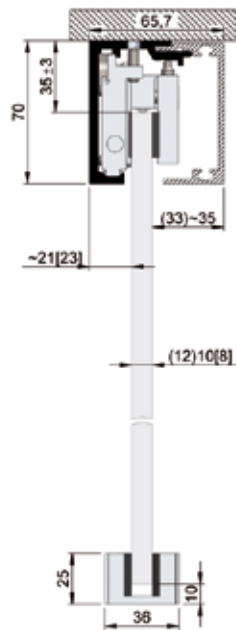



# SlideTec optima 150 Wall Mounting single door



**i** Mounting wall mounting · Version single door · Door weight max. 150 kg · Glass thickness tempered glass 8 - 12 mm · Glass thickness laminated safety glass consisting of tempered glass/PVB/tempered glass 8.76 - 12.76 mm · Glass processing tempered glass none · Glass processing laminated safety glass yes · Material aluminium · profile pre-drilled

### Included in delivery:

- 2x Carriages
- 2x End stops
- 1x Top track, wall mounting
- 1x Bottom guide (when using 12.76 mm laminated safety glass, please request special guide)
- 2x End caps, lateral
- 1x Cover incl. fixing

Art. No.	Length · Finish
BO 5101552N	2000 mm · anodised aluminium EV1
BO 5101554N	2500 mm · anodised aluminium EV1
BO 5101556N	3000 mm · anodised aluminium EV1
BO 5101558N	2000 mm · stainless steel look
BO 5101560N	2500 mm · stainless steel look
BO 5101562N	3000 mm · stainless steel look

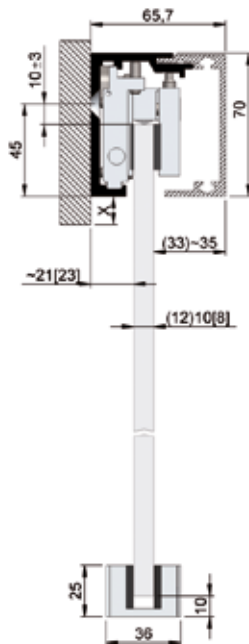



## SlideTec optima 150 Ceiling Mounting with Fixed Sidelight single door



Please note: Please order cover caps separately. · U-profile for fixed glass needs to be ordered separately

**i** Mounting ceiling mounting · Version single door · Door weight max. 150 kg · Glass thickness tempered glass 8 - 12 mm · Glass thickness laminated safety glass consisting of tempered glass/PVB/tempered glass 8.76 - 12.76 mm · Glass processing tempered glass none · Glass processing laminated safety glass yes · Material aluminium · profile pre-drilled

### Included in delivery:

- 2x Carriages
- 2x End stops
- 1x Running track ceiling mounting with fixed sidelight
- 1x Cover incl. fixing
- 1x U-cover for fixed sidelight profile
- 1x Bottom guide (when using 12.76 mm laminated safety glass, please request special guide)

Art. No.	Length · Finish
BO 5101563N	2000 mm · anodised aluminium EV1
BO 5101564N	2500 mm · anodised aluminium EV1
BO 5101565N	3000 mm · anodised aluminium EV1
BO 5101566N	2000 mm · stainless steel look
BO 5101567N	2500 mm · stainless steel look
BO 5101568N	3000 mm · stainless steel look

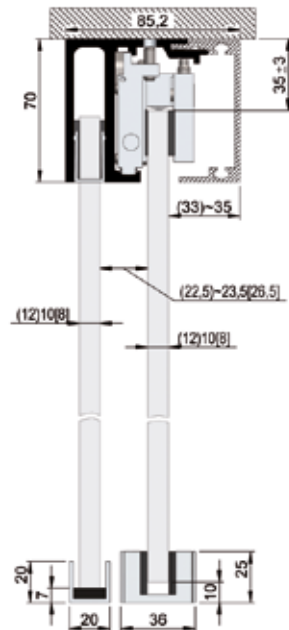

## Damping Mechanism SlideTec optima 150

Minimum door width with single-sided damping 510 mm, with double-sided damping 800 mm



**i** Version damping mechanism on both sides (without glass processing)

### Included in delivery:

- 2x Damping Mechanism (BO 5101571)
- 4x Damping Mechanism (BO 5101572)
- 1x Release bolt

Art. No.	Weight
BO 5101571	max. 80 kg
BO 5101572	max. 150 kg

# Willach Portavant 80 automatic



## Portavant 80 automatic Sliding Door Complete Set Wall Mounting single door



R = Room Height · LW = Clear Width · A = Glass width sliding door ·  
H1 = Glass height sliding door · C = Length of running track

**i** Mounting wall mounting · Version single door · Door weight max. 80 kg · Glass thickness tempered glass 8, 10, 12 mm · Glass thickness laminated safety glass consisting of tempered glass/PVB/tempered glass 8.76; 10.76; 12.76 mm · Aspect ratio width : height < 1 : 2.5

### Included in delivery:

- 1x Top track, wall mounting
- 1x Cover
- 1x Accessory Set
- 1x Drive belt

Art. No.	Finish · Length
BO 5215101	anodised aluminium EV1 · 2596 mm
BO 5215102	stainless steel look C31 · 2596 mm

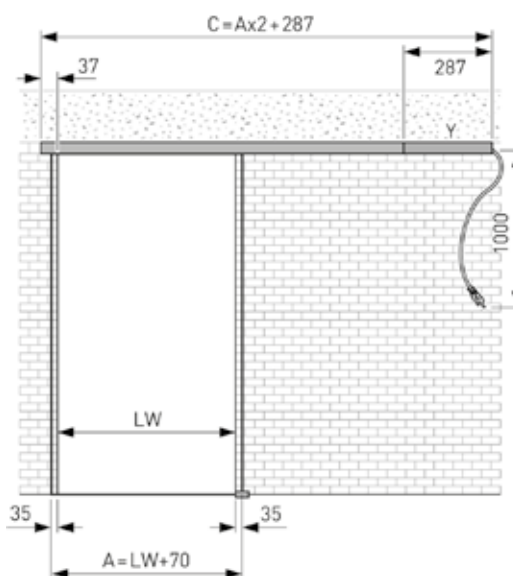
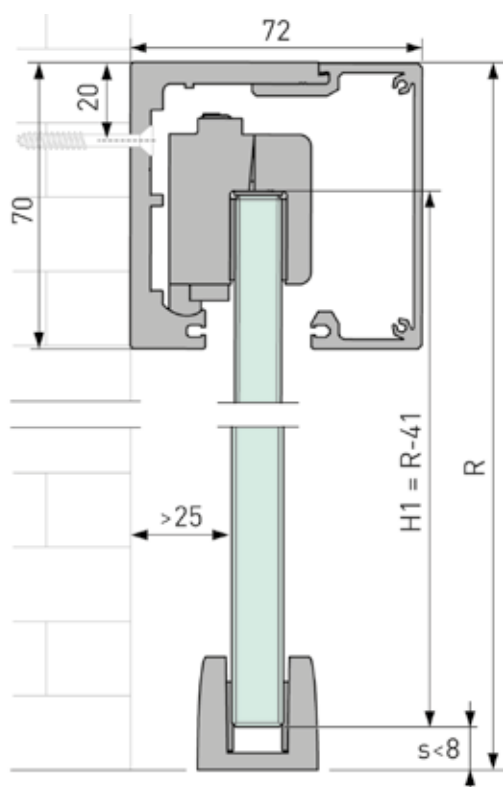



# Portavant 80 automatic Sliding Door Complete Set Ceiling Mounting single door



R = Room Height · LW = Clear Width · A = Glass width sliding door ·  
 H1 = Glass height sliding door · C = Length of running track

**i** Mounting ceiling mounting · Version single door · Door weight max. 80 kg · Glass thickness tempered glass 8, 10, 12 mm · Glass thickness laminated safety glass consisting of tempered glass/PVB/tempered glass 8.76; 10.76; 12.76 mm · Aspect ratio width : height < 1 : 2.5

- Included in delivery:**
- 1x Top track ceiling mounting
  - 1x Cover
  - 1x Accessory Set
  - 1x Drive belt

Art. No.	Finish · Length
BO 5215105	anodised aluminium EV1 · 2596 mm
BO 5215106	stainles steel look C31 · 2596 mm

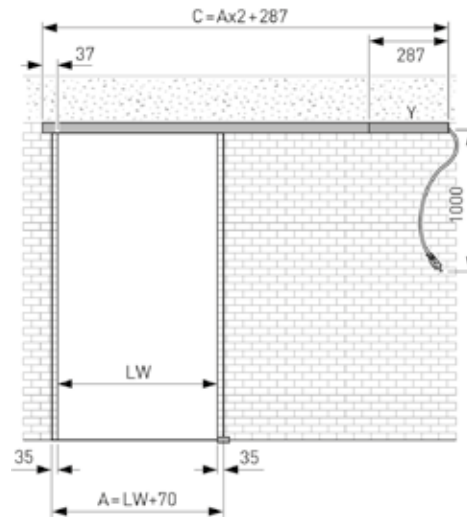
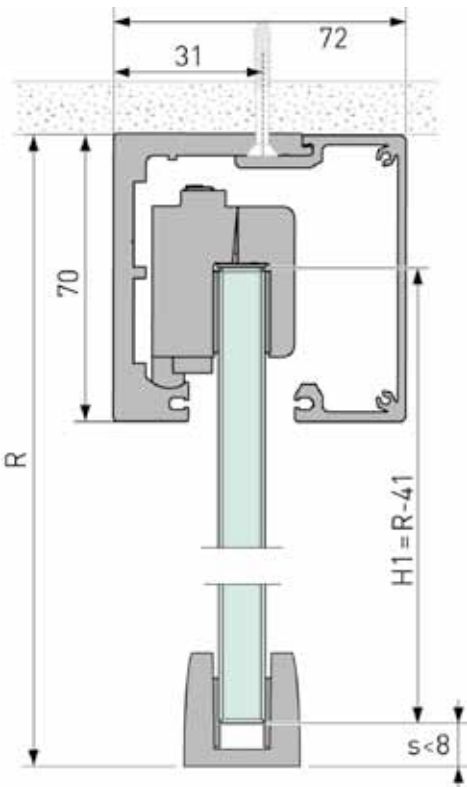



## Motion Sensor for Portavant 80 automatic



Motion sensor recognises direction of movement and blocks out cross movement; incl. black cover cap, 3 m connecting cable and cable clamps

**i** Mounting with supplied connecting cable

Art. No.	Description · Colour:
----------	-----------------------

BO 5215124	Motion Sensor - black
------------	-----------------------



## Radio Transmitter for Portavant 80 automatic Motion Sensor



Radio transmitter for use in combination with a wall push button, which you can choose from any range of flush-mounted push buttons · When using the pushbutton transmitter, please also order BO 5215121.

Art. No.
----------

BO 5215123	Radio Transmitter
------------	-------------------

**Please note:**

Radio receiver BO 5215121  
must also be ordered!



## Portavant 80 automatic Radio Receiver



For integration into control unit · for Portavant 80 automatic

Art. No.
----------

BO 5215121	Radio Receiver
------------	----------------



Self-closing Patch Fitting



# 04 | Pivot Door Systems

## Self-closing Patch Fitting

### ▶ New Bohle Patch Corner Fitting System



The entire technology of the Self-closing Patch Fitting is housed in a subtly designed fitting. A floor recess is therefore not required in contrast to conventional floor-mounted door closers. It is assembled by simply screwing the base plate onto the existing surface. Bohle's self closing patch fitting has been tested to European standards for long durability and excellent functionality in accordance with DIN EN 1154. - tested as per DIN 1154 with 500,000 cycles · For averagely frequented buildings · Variable closing speeds · Can be used with stopper

**i** Door width 750 - 1000 mm · Description opens both ways · Glass thickness tempered glass 10 - 12 mm · Door weight max. 100 kg · Hold position 90° · Door height max. 2500 mm · Adjustable zero position +/- 4° · ambient temperature - 20°C - +50°C · Closing speed adjustable 150° - 10° / 10° - 0° · Closing force EN3 · Opening angle 150° · anticorrosion 3 · suitable for inside and outside

#### Included in delivery:

- 1 x BO 5214265 Patch fitting Bohle Patch PT 20 Plus top
- 1 x BO 5214350 Bohle Self-closing Patch Fitting
- 1 x BO 5214287 Top Pivot Bohle Patch PT 24

Art. No.	Name
BO 5214351	New Bohle Patch Corner Fitting System

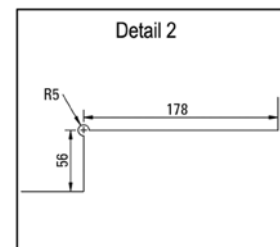
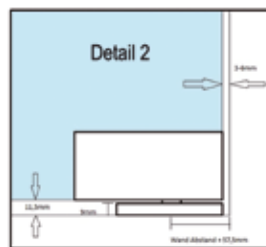
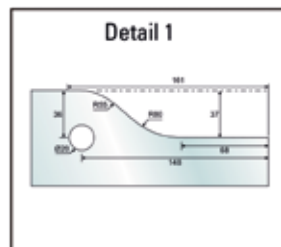
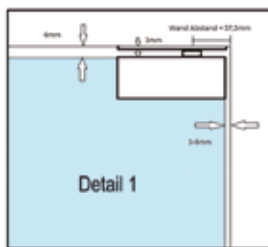



# Bohle FrameTec Select Frame System

## ▶ Bohle FrameTec Select complete frame



The aluminium frame for mounting all conventional all-glass doors with or without fixed sidelights and overpanel glazing. The hinges and strike plate can be inserted quickly and easily into the multifunction channel. The narrow channel is tightly covered with the clip-on profile. · Can be cut individually to size · Set pre-assembled for door glass thicknesses of 8-10.76 mm, sidelight/overpanel thicknesses of 10-12.76 mm (for different glass thicknesses please order gaskets separately)



Note: Please order matching door hinges separately, e.g. BO 5206664, BO 5206639 · for fixed glass enclosures use U-profiles · additional mounting plate BO 5220725

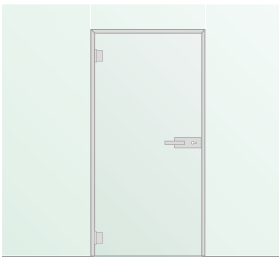

**i** Material aluminium · Finish anodised E6/EV1 · Glass thickness of tempered/laminated safety glass door (from 2x tempered glass) 8 - 10.76 mm · Glass thickness of tempered/laminated safety glass sidelight/overpanel 10 - 12.76 mm · 1-door version · Gaskets black

### Included in delivery:

- Frame Profile
- Cover profile
- Rebate gasket
- Base gasket
- Glazing gasket for 8 - 8.76 mm
- Glazing gasket for 10 - 10.76 mm
- 2x Corner Clamp bottom
- 4x Corner Clamp top
- 1x Strike Plate short
- 1x Strike Plate long
- 6x Hammerhead nuts and bolts for hinge mounting and strike plate
- 2x Mounting plate for door hinge

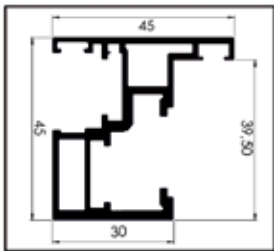

Art. No.	Type · Outer frame dimensions
BO 5220719	FTS1 · 1040 x 2400 mm
BO 5220702	FTS2 · 1040 x 3000 mm

## ▶ U-Profile



U-profile for fixed glazing · Supplied without gasket

**i** Material aluminium · Finish anodised E6/EV1 · Length 6000 mm · Dimensions 35 x 25 mm

Art. No.
BO 5220713

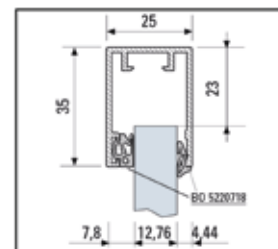
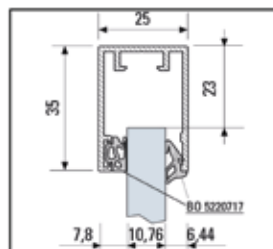
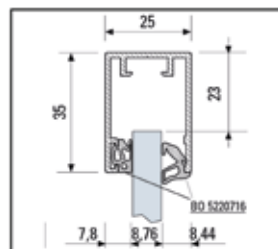

## ▶ Two-piece Clamp-on Profile



Clamp-on profile for fixed glazing · Supplied without gasket



Material aluminium · Finish anodised E6/EV1 · Length 6000 mm · Dimensions 25 x 25 mm

Art. No.

BO 5220714

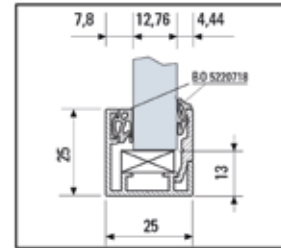
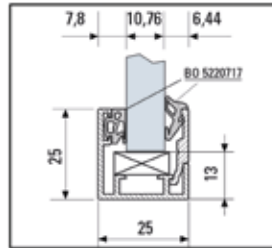
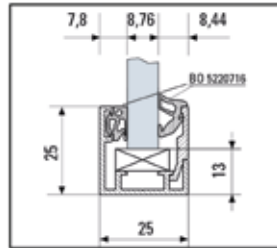

## ▶ U-Profile



U-profile for fixed glazing · Supplied without gasket



Material aluminium · Finish anodised E6/EV1 · Length 6000 mm · Dimensions 25 x 25 mm

Art. No.

BO 5220712

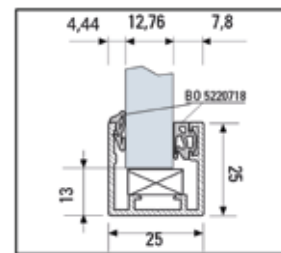
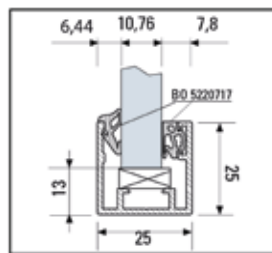
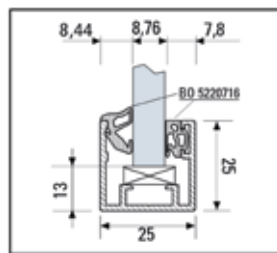

## ▶ FrameTec Select End cap set for U-profiles

We recommend fixing the end caps with standard silicone or double-sided adhesive tape.



Colour black · Material plastic · Sales unit 10 items

Art. No.

BO 5220720

## ▶ Sealing Set

Plug-in gasket · Suitable for profiles BO 5220714, 5220712, 5220713



Length 6 m

Included in delivery:  
6 m Glazing gasket  
6 m Base gasket

Art. No. For glass thickness

BO 5220716 8-8.76 mm

BO 5220717 10-10.76 mm

BO 5220718 12-12.76 mm

**TUV NORD**  
Sound insulation tested  
in accordance with  
DIN 4109



# Bohle FrameTec Premium Frame System

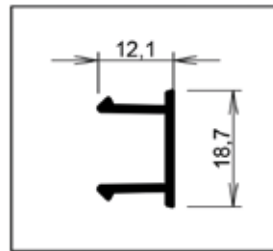
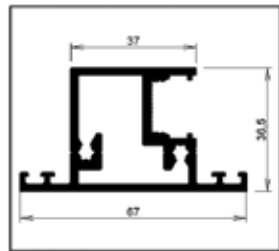
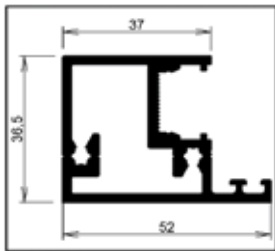

## Note:

Special sizes and further product types available on request. We will gladly assist you with the planning.



## Bohle FrameTec Premium complete frame, type FTP1 1040 x 2200 mm



The aluminium frame for mounting all conventional all-glass doors with or without fixed sidelights and overpanel glazing. · can be cut to the desired length · Sound insulation tested in accordance with DIN 4109 · Set pre-assembled for door glass thicknesses of 8-10.76 mm

Note: Please order matching door hinges separately, e.g. BO 5206664, BO 5206639

**i** Material aluminium · Finish anodised E6/EV1 · Glass thickness of tempered/laminated safety glass door (from 2x tempered glass) 8 - 10.76 mm · Outer frame dimensions width x height 1040 x 2200 mm · 1-door version · DIN-left / right · Gaskets grey · Door size max. 959 x 2152 mm

When used together with Bohle GS-A Drop Down Seal (BO 5220721-5220724), the frame meets the requirements according to sound insulation class 1 (33dB).

### Included in delivery:

- L-profile
- Cover profile
- Rebate gasket
- 2x Corner Clamp top
- 2x Mounting plate for door hinge
- 12x Flat Head Screw M5 x 14 mm

### Art. No.

BO 5220706



## Bohle FrameTec Premium complete frame, type FTP2 1300 x 2600 mm



The aluminium frame for mounting all conventional all-glass doors with or without fixed sidelights and overpanel glazing. · can be cut to the desired length · Sound insulation tested in accordance with DIN 4109 · Set pre-assembled for door glass thicknesses of 8-10.76 mm

Note: Please order matching door hinges separately, e.g. BO 5206664, BO 5206639 · additional mounting plate BO 5220740

**i** Material aluminium · Finish anodised E6/EV1 · Glass thickness of tempered/laminated safety glass door (from 2x tempered glass) 8 - 10.76 mm · Outer frame dimensions width x height 1300 x 2600 mm · 1-door version · DIN-left / right · Gaskets grey · Door size max. 1212 x 2552 mm

When used together with Bohle GS-A Drop Down Seal (BO 5220721-5220724), the frame meets the requirements according to sound insulation class 1 (33dB).

### Included in delivery:

L-profile  
Cover profile  
Rebate gasket  
2x Corner Clamp top  
2x Mounting plate for door hinge  
12x Flat Head Screw M5 x 14 mm

### Art. No.

BO 5220707



## Bohle FrameTec Premium complete frame, type FTP3 1040 x 3000 mm



The aluminium frame for mounting all conventional all-glass doors with or without fixed sidelights and overpanel glazing. · can be cut to the desired length · Sound insulation tested in accordance with DIN 4109 · Set pre-assembled for door glass thicknesses of 8-10.76 mm, overpanel thicknesses of 4-10.76 mm

Note: Please order matching door hinges separately, e.g. BO 5206666, BO 5206639

**i** Material aluminium · Finish anodised E6/EV1 · Glass thickness of tempered/laminated glass door (from 2x tempered glass) 8 - 10.76 mm · Glass thickness of tempered/laminated glass overpanel (from 2x tempered glass) 4 - 10.76 mm · Outer frame dimensions width x height 1040 x 3000 mm · 1-door version · DIN-left / right · Gaskets grey · Door size max. 959 x 1972 mm

When used together with Bohle GS-A Drop Down Seal (BO 5220721-5220724), the frame meets the requirements according to sound insulation class 1 (33dB).

### Included in delivery:

L-profile  
T-profile  
Glazing beads  
Cover profile  
Rebate gasket  
internal glazing gasket 3 - 4 mm, 5 - 6 mm, 7 mm  
outer glazing gasket 4 mm  
2x Corner Clamp top  
2x Mounting plate for door hinge  
12x Flat Head Screw M5 x 14 mm  
4x Flat Head Screw M5 x 55 mm

### Art. No.

BO 5220708



## Bohle FrameTec Premium complete frame, type FTP4 2000 x 2200 mm



The aluminium frame for mounting all conventional all-glass doors with or without fixed sidelights and overpanel glazing. · can be cut to the desired length · Sound insulation tested in accordance with DIN 4109 · Set pre-assembled for door thicknesses of 8-10.76 mm, sidelight thicknesses of 4-10.76 mm

Note: Please order matching door hinges separately, e.g. BO 5206664, BO 5206639

**i** Material aluminium · Finish anodised E6/EV1 · Glass thickness of tempered/laminated glass door (from 2x tempered glass) 8 - 10.76 mm · Glass thickness of tempered/laminated glass sidelight (from 2x tempered glass) 4 - 10.76 mm · Outer frame dimensions width x height 2000 x 2200 mm · 1-door version · DIN-left / right · Gaskets grey · Door size max. 959 x 2152 mm

When used together with Bohle GS-A Drop Down Seal (BO 5220721-5220724), the frame meets the requirements according to sound insulation class 1 (33dB).

### Included in delivery:

L-profile  
T-profile  
Glazing beads  
Cover profile  
Rebate gasket  
internal glazing gasket 3 - 4 mm, 5 - 6 mm, 7 mm  
outer glazing gasket 4 mm  
2x Corner Clamp top  
2x Mounting plate for door hinge  
12x Flat Head Screw M5 x 14 mm  
4x Flat Head Screw M5 x 55 mm

### Art. No.

BO 5220709



## Bohle FrameTec Premium complete frame, type FTP5 2000 x 3000 mm



The aluminium frame for mounting all conventional all-glass doors with or without fixed sidelights and overpanel glazing. · can be cut to the desired length · Sound insulation tested in accordance with DIN 4109 · Set pre-assembled for door thicknesses of 8-10.76 mm, sidelight thicknesses of 4-10.76 mm

Note: Please order matching door hinges separately, e.g. BO 5206664, BO 5206639

**i** Material aluminium · Finish anodised E6/EV1 · Glass thickness of tempered/laminated safety glass door (from 2x tempered glass) 8 - 10.76 mm · Glass thickness of tempered/laminated safety glass sidelight/overpanel (from 2x tempered glass) 4 - 10.76 mm · Outer frame dimensions width x height 2000 x 3000 mm · 1-door version · DIN-left / right · Gaskets grey · Door size max. 959 x 1972 mm

When used together with Bohle GS-A Drop Down Seal (BO 5220721-5220724), the frame meets the requirements according to sound insulation class 1 (33dB).

### Included in delivery:

L-profile  
T-profile  
Glazing beads  
Clip-on cover profile  
Rebate gasket  
internal glazing gasket 3 - 4 mm, 5 - 6 mm, 7 mm  
outer glazing gasket 4 mm  
2x Corner Clamp top  
2x Mounting plate for door hinge  
12x Flat Head Screw M5 x 14 mm  
10x Flat Head Screw M5 x 55 mm

### Art. No.

BO 5220710





## Bohle FrameTec Premium complete frame, type FTP6 2000 x 3000mm



The aluminium frame for mounting all conventional all-glass doors with or without fixed sidelights and overpanel glazing. · can be cut to the desired length · Sound insulation tested in accordance with DIN 4109 · Set pre-assembled for door glass thicknesses of 8-10.76 mm, sidelight/overpanel thicknesses of 4-10.76 mm

Note: Please order matching door hinges separately, e.g. BO 5206664, BO 5206639

**i** Material aluminium · Finish anodised E6/EV1 · Glass thickness of tempered/laminated safety glass door (from 2x tempered glass) 8 - 10.76 mm · Glass thickness of tempered/laminated safety glass sidelight/overpanel (from 2x tempered glass) 4 - 10.76 mm · Outer frame dimensions width x height 2000 x 3000 mm · 1-door version · DIN-left / right · Gaskets grey · Door size max. 834 x 1972 mm

When used together with Bohle GS-A Drop Down Seal (BO 5220721-5220724), the frame meets the requirements according to sound insulation class 1 (33dB).

### Included in delivery:

L-profile  
T-profile  
Glazing beads  
Cover profile  
Rebate gasket  
internal glazing gasket 3 - 4 mm, 5 - 6 mm, 7 mm  
outer glazing gasket 4 mm  
2x Corner Clamp top  
2x Mounting plate for door hinge  
12x Flat Head Screws M5 x 14 mm  
12x Flat Head Screws M5 x 55 mm  
4x Cross connectors  
4x Flat Head Screws 3.5 x 19 mm  
4x Socket head screws M6 x 45 mm

### Art. No.

BO 5220711



## Bohle GS-A Drop Down Seals



Ideal for sealing already-installed smooth glass, metal, aluminium, wooden and plastic doors · Sealing strips can be trimmed, please consider the minimum length · Incl. cover strip silver-coloured · Sound insulation 41 dB

**i** Finish anodised aluminium EV1 · Material aluminium

Art. No.	Length
BO 5220721	610 - 735 mm
BO 5220722	736 - 860 mm
BO 5220723	861 - 985 mm
BO 5220724	986 - 1110 mm

# Door Fittings

## ▶ Studio Private Line Glass Door Latch, curved, non locking lock



For lever handles in the forward position · Latch, non locking · noise-reducing internal plastic parts · nickel plated brass latch bolt · left and right hand installation · tested according to DIN 18251, class 3 (cycles: latch tests 200,000, bolt tests 50,000) · suitable for standard lever handles without roses which are supplied with 8 mm square pin and 18 mm shoulder guide · M5 stainless steel screws (torque setting 3 Nm)

**i** Glass thickness tempered glass 8 (10) mm · rebate depth 24 (26) mm · Material aluminium

Art. No.	Finish
BO 5206805	anodised aluminium EV1
BO 5206806	stainless steel look

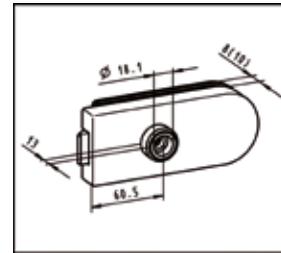
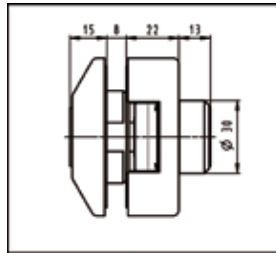
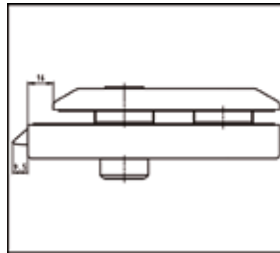
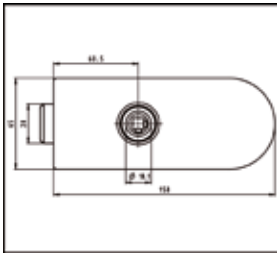

## ▶ Studio Private Line Glass Door Lock, curved, Euro profile cylinder



Lock prepared for profile cylinder · noise-reducing internal plastic parts · nickel plated brass latch bolt · single throw / 19 mm bolt projection · left and right hand installation · tested according to DIN 18251, class 3 (cycles: latch tests 200,000, bolt tests 50,000) · 61 mm profile cylinder, flush on counterplate side · suitable for standard lever handles without roses which are supplied with 8 mm square pin and 18 mm shoulder guide · M5 stainless steel screws (torque setting 3 Nm)

**i** Glass thickness 8 (10) mm · rebate depth 24 (26) mm · Material aluminium

Art. No.	Finish
BO 5206809	anodised aluminium EV1
BO 5206810	stainless steel look

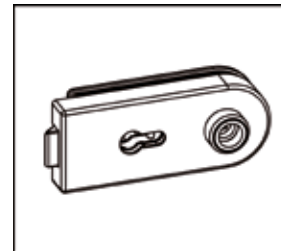
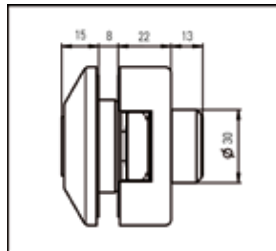
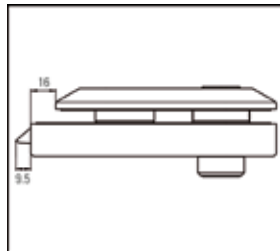
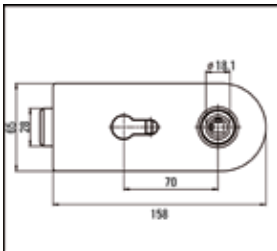

## ▶ Double Profile Cylinder



With emergency function

**i** With 3 keys · Version individual key · Length 27.5 / 27.5 mm · Finish matt nickel-plated · Material brass

Art. No.
BO 5206656

▶ Studio Door Handle L-Shaped



❗ Glass thickness 8, 10 mm · Shape L · Material aluminium

Art. No.	Finish
BO 5206845	anodised aluminium EV1
BO 5206846	stainless steel look

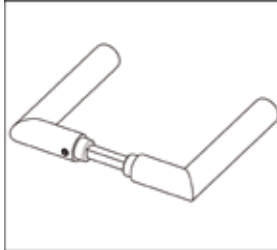
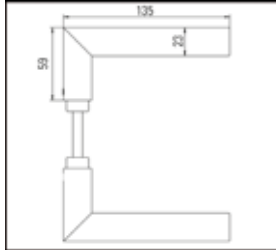

▶ Glass Door Hinge with Screw-On Plate Aluminium



❗ Glass thickness 8 - 10 mm · Door weight per pair max. 38 kg · Projection max. 1000 mm · Material aluminium

Art. No.	Finish
BO 5206664	anodised aluminium EV1
BO 5206663	stainless steel look

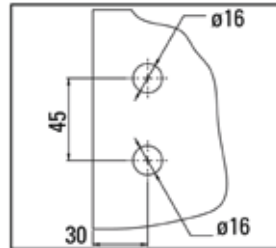
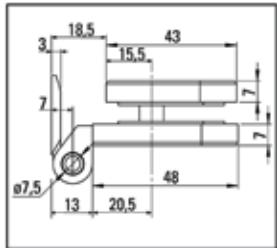
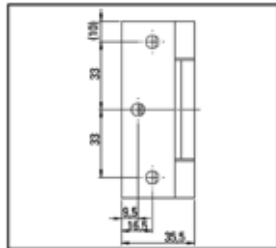
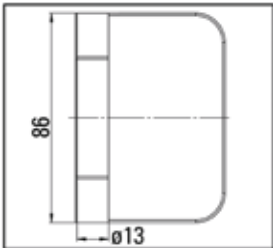

▶ Glass Door Hinge with Square Screw-on Plate



❗ Door weight per pair max. 80 kg · Projection max. 1000 mm · Glass thickness 8 - 10 mm · Finish matt brushed · Material stainless steel

Art. No.
BO 5206639

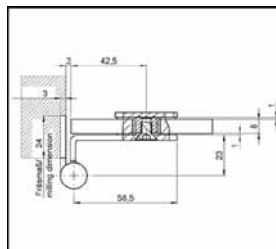
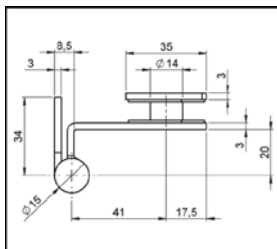
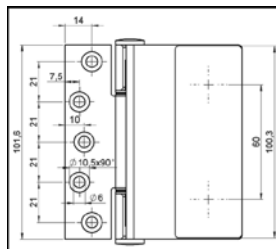
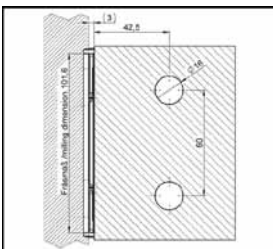



Handle for All-Glass Doors BO 5213749

# 05 | Accessories for Interior Fit-Out

## Glass Door Handles

### ▶ Handle for All-Glass Doors $\varnothing$ 19 mm



**i** Glass thickness 4 - 12 mm · Drill hole in glass  $\varnothing$  10 mm · Material stainless steel (AISI 1.304) · Finish matt brushed

**Included in delivery:**

Screws for doors up to 40 mm included (for use with: wood, steel, aluminium, plastic)



Art. No.	$\varnothing$ · L · C-C · H
BO 5213740	19 mm · 250 mm · 150 mm · 52 mm
BO 5213742	19 mm · 400 mm · 300 mm · 52 mm
BO 5213745	19 mm · 600 mm · 500 mm · 52 mm
BO 5213746	19 mm · 800 mm · 600 mm · 52 mm
BO 5213747	19 mm · 1000 mm · 800 mm · 52 mm
BO 5213738	19 mm · 300 mm · 200 mm · 52 mm
BO 5213739	19 mm · 500 mm · 300 mm · 52 mm

### ▶ Handle for All-Glass Doors $\varnothing$ 25 mm



**i** Glass thickness 4 - 12 mm · Drill hole in glass  $\varnothing$  14 mm · Material stainless steel (AISI 1.304) · Finish matt brushed

**Included in delivery:**

Screws for doors up to 40 mm included (for use with: wood, steel, aluminium, plastic)

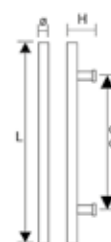

Art. No.	$\varnothing$ · L · C-C · H
BO 5213749	25 mm · 300 mm · 200 mm · 65 mm
BO 5113701	25 mm · 400 mm · 300 mm · 65 mm
BO 5113702	25 mm · 500 mm · 400 mm · 65 mm
BO 5113703	25 mm · 600 mm · 400 mm · 65 mm
BO 5113704	25 mm · 700 mm · 500 mm · 65 mm
BO 5113705	25 mm · 800 mm · 600 mm · 65 mm
BO 5113706	25 mm · 1000 mm · 800 mm · 65 mm
BO 5113707	25 mm · 1200 mm · 1000 mm · 65 mm
BO 5113708	25 mm · 1600 mm · 1000 mm · 65 mm
BO 5113709	25 mm · 1800 mm · 1000 mm · 65 mm
BO 5113710	25 mm · 2000 mm · 1000 mm · 65 mm

## ▶ Sliding Glass Door Handle with Opening



**i** Glass thickness 8, 10 + 12 mm · Drill hole in glass  $\varnothing$  50 mm · Material stainless steel · Finish matt brushed

Art. No.

BO 5214216N

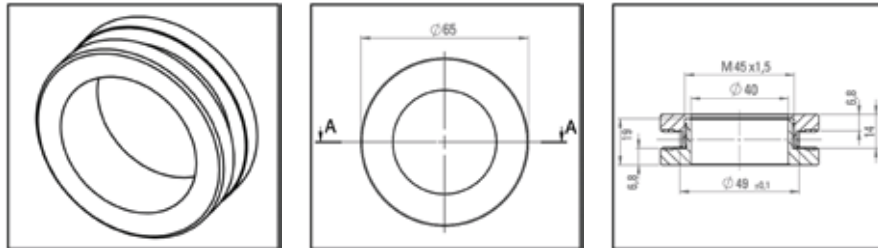

## ▶ Sliding Glass Door Handle



**i** Glass thickness 8, 10 + 12 mm · Drill hole in glass  $\varnothing$  50 mm · Version · Material stainless steel · Finish matt brushed

Art. No.

BO 5214217N

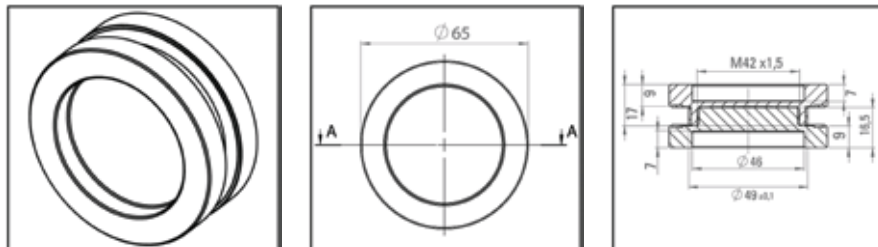

## ▶ Flush Handle



With two adhesive strips each

**i** Glass thickness 8 + 10 mm · Drill hole in glass  $\varnothing$  50 mm · Material stainless steel · Finish matt brushed · Size 65 x 65 mm · Shape square-edged

Art. No.

BO 5101615

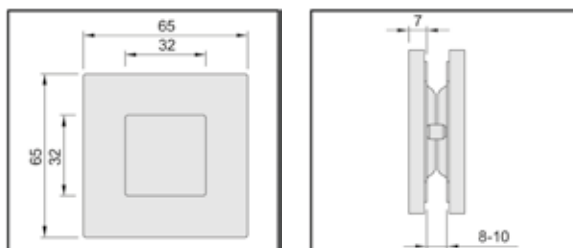

# Glass Door Locks

## ▶ Bohle Patch Hook Lock with Keep and hook bolt



When used as a centre lock on double doors, one door must be used as a slave door. · Can be used for DIN left and DIN right · No glass cutouts or drill holes required, clamp-on function · suitable for sliding and double doors · incl. 3 keys

**i** Glass thickness tempered glass 10 - 12 mm

Art. No.	Finish
B0 5214285	matt stainless steel

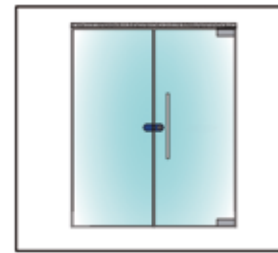
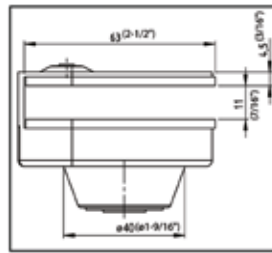
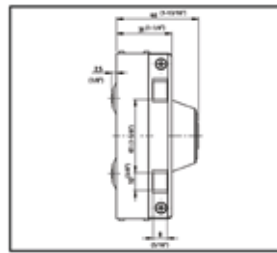
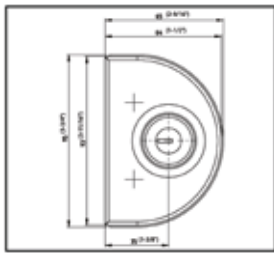

## ▶ Bohle Patch Hook Lock with Keep



Can be used for DIN left and DIN right · No glass cutouts or drill holes required, clamp-on function · suitable for sliding doors · incl. 3 keys

**i** Glass thickness tempered glass 10 - 12 mm

Art. No.	Finish
B0 5214286	matt stainless steel

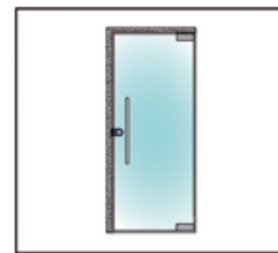
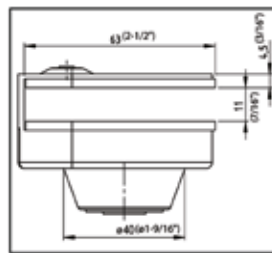
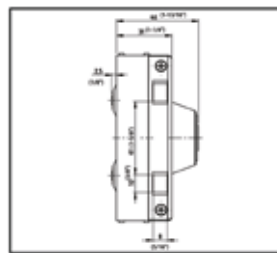
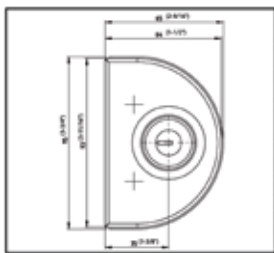

# Profiles for Glass Partitions

## ▶ U-Channels 19 x 13 x 19 x 2 mm



For installing fixed glass partitions · with radius corners · drilling guide in the bottom of the profile

**i** Glass thickness 8 mm · Material aluminium · Material thickness 2.0 mm

Art. No.	Length · Finish
BO 6703411	2150 mm · anodised E6/EV1
BO 6703412	2150 mm · polished anodised E3/EV1
BO 6703413	2150 mm · stainless steel look brushed E1/C31
BO 6703418	2500 mm · anodised E6/EV1
BO 6703430	2500 mm · polished anodised E3/EV1
BO 6703419	2500 mm · stainless steel look brushed E1/C31
BO 6703436	5000 mm · anodised E6/EV1
BO 6703437	5000 mm · polished anodised E3/EV1
BO 6703438	5000 mm · stainless steel look brushed E1/C31

## ▶ U-Channels 19 x 15 x 19 x 2 mm



For installing fixed glass partitions · with radius corners · drilling guide in the bottom of the profile

**i** Glass thickness 10 mm · Material thickness 2.0 mm · Material aluminium

Art. No.	Length · Finish
BO 6703423	2150 mm · anodised E6/EV1
BO 6703424	2150 mm · polished anodised E3/EV1
BO 6703425	2150 mm · stainless steel look brushed E1/C31
BO 6703429	2500 mm · anodised E6/EV1
BO 6703431	2500 mm · polished anodised E3/EV1
BO 6703432	2500 mm · stainless steel look brushed E1/C31
BO 6703426	5000 mm · anodised E6/EV1
BO 6703427	5000 mm · polished anodised E3/EV1
BO 6703428	5000 mm · stainless steel look brushed E1/C31

## ▶ U-Channels 19 x 17 x 19 x 2 mm

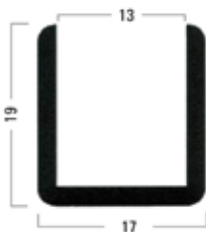

For installing fixed glass partitions · with radius corners · drilling guide in the bottom of the profile

**i** Glass thickness 12 mm · Material thickness 2.0 mm · Material aluminium

Art. No.	Length · Finish
BO 6703443	2150 mm · anodised E6/EV1
BO 6703444	2150 mm · polished anodised E3/EV1
BO 6703445	2150 mm · stainless steel look brushed E1/C31
BO 6703434	2500 mm · anodised E6/EV1
BO 6703433	2500 mm · polished anodised E3/EV1
BO 6703435	2500 mm · stainless steel look brushed E1/C31
BO 6703446	5000 mm · anodised E6/EV1
BO 6703447	5000 mm · polished anodised E3/EV1
BO 6703448	5000 mm · stainless steel look brushed E1/C31



## ▶ Set of end caps, for U-Channels



We recommend fixing the end caps with standard silicone or double-sided adhesive tape.

**i** Finish silver colour · Material Plastic · Packaging unit 10 items

Art. No.	Dimensions
BO 6703461	19 x 13 x 19 mm
BO 6703462	19 x 15 x 19 mm

## Clamp-On Profiles

### ▶ Clamp-on Frame Profile for Wall Connection

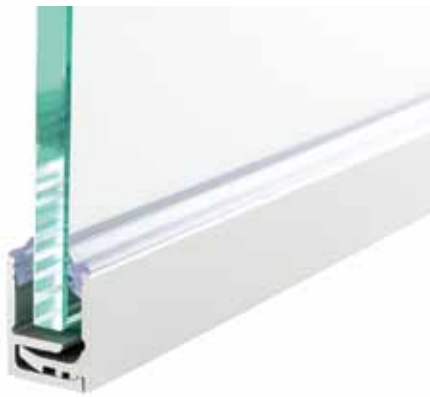

Note: You will find gaskets to suit the respective glass thickness in the mounting instructions.

**i** Glass thickness 8- 21.52 mm · Material Aluminium · Dimensions 24 x 30 mm

Art. No.	Length · Finish
BO 5201750	3000 mm · anodised E6/EV1
BO 5201751	3000 mm · stainless steel look E4/C31
BO 5201752	5000 mm · anodised E6/EV1
BO 5201753	5000 mm · stainless steel look E4/C31

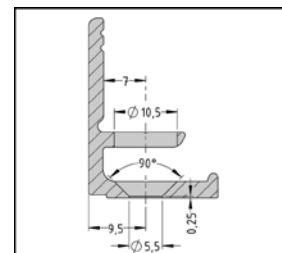
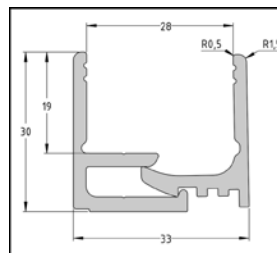
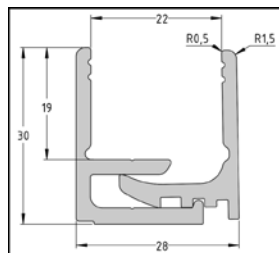
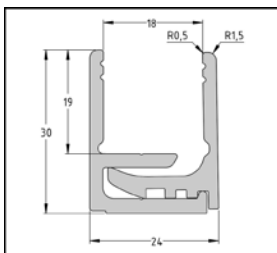

Glass thickness	Suitable gaskets
ESG 8 mm	BO 5201715
VSG 8.76 mm	BO 5201715
ESG 10 mm	BO 5201714
ESG 12 mm	BO 5201713
VSG 12.6 mm	BO 5201713
ESG 15 mm	BO 5201714
VSG 16.76 mm	BO 5201713
VSG 17.52 mm	BO 5201713
VSG 21.52 mm	BO 5201713

## ▶ Universal PVC Profile



for clamp- on profile for wall connection BO 5201750 - 53

**i** Length 2 x 5 m · Finish transparent · suitable for BO 5201750 - 53

Art. No.	Width
BO 5201713	2 mm
BO 5201714	3 mm
BO 5201715	4 mm

## Adhesive Bonding Tapes

### ▶ Bohle Duplocoll® Adhesive Bonding Tapes



- For different applications, such as all-glass partition walls, furniture, shower cubicles and much more
- For different materials, such as wood, aluminium, plastic, ceramic or glass
- High transparency due to a light refractive index almost identical to glass
- Antimicrobial effect - inhibits growth of microorganisms
- By sealing the edges of the adhesive tape, Duplocoll® becomes dry after adhesion and resistant to external influences
- Elongation of up to 500% and highly split-resistant
- Resistant to chemicals and softeners
- Very good initial tack, lasting ultimate bonding strength
- Also suitable for rough surfaces: The viscoelastic adhesive film distributes evenly across rough surfaces.
- Resistant to ageing and UV radiation, economic, high quality and does not affect the external appearance of the construction

**i** Thickness 3 mm · Colour transparent · Roll length 12 m · Max. allowable continuous temperature: -40°C - +100°C

Please note: Please use the corresponding applicator to ensure simple and precise application on the glass edge.

Art. No.	Description · Width · Glass thickness
BO 5207936	Adhesive Bonding Tapes · 5 mm · 8 mm
BO 5207938	Adhesive Bonding Tapes · 7 mm · 10 mm
BO 5207935	Adhesive Bonding Tapes · 9 mm · 12-12.7 mm
BO 5209630	Adhesive Bonding Tapes · 14 mm · 17.52 mm
BO 5207939N	Applicator · for glass 8, 10 mm
BO 5207948	Inlay for BO 5207939N · for glass 10, 12 mm
BO 5207946N	Applicator · for glass 10.76; 12.7; 12.76 mm
BO 5207947	Inlay for BO 5207946N · for glass 8.76; 10.76 mm
BO 5207949	Inlay for BO 5207946N · for glass 17.52 mm

We recommend seaming tools BO 650.30 or BO 650.32 as auxiliary tools for joining the glass panes.





Swing hinge

# 06

## Furniture Fittings

### Glass Door Hinge

#### ▶ Glass Door Hinge inset

Simple mounting due to retractable axle · with eccentric bush and wood screw · can be used on the right or left side



**i** Size 65 x 40 mm · Glass thickness 6 - 8 mm · Door weight maximum 16 kg · Door width maximum 400 mm · Distance door/shelves min. 20 mm · Material brass · Packaging unit 1 pair · with glass processing

Art. No.	Finish
BO 5200051	chrome-plated
BO 5200151	stainless steel look

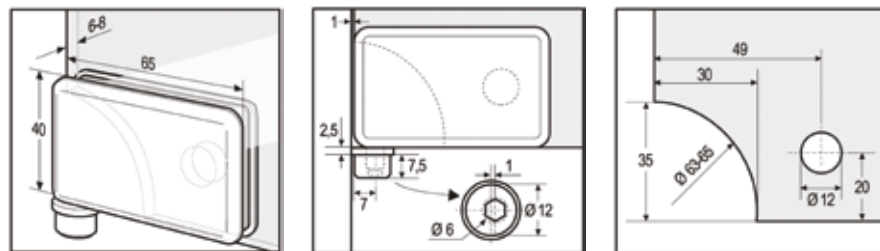

#### ▶ Glass Door Hinge inset

Can be used on the right or left side



**i** Size 65 x 40 mm · Glass thickness 6 - 8 mm · Door weight maximum 16 kg · Door width maximum 400 mm · Mounting plate 3 mm · Height deduction dimension 9 mm · Distance door/shelves min. 20 mm · Material brass · Packaging unit 1 pair · with glass processing

Art. No.	Finish
BO 5200053	chrome-plated
BO 5200153	stainless steel look

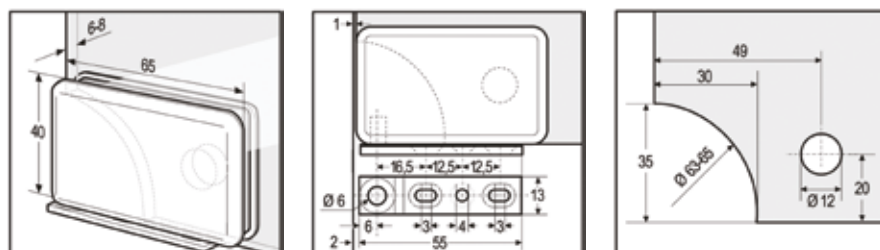

## ▶ Glass Door Hinge inset

Can be used on the right or left side



**i** Size 74 x 42 mm · Glass thickness 6 - 8 mm · Door weight maximum 25 kg · Door width maximum 500 mm · Mounting plate 3 mm · Height deduction dimension 9 mm · Distance door/shelves min. 20 mm · Material brass · Packaging unit 1 pair · with glass processing

Art. No.	Finish
BO 5200052	chrome-plated

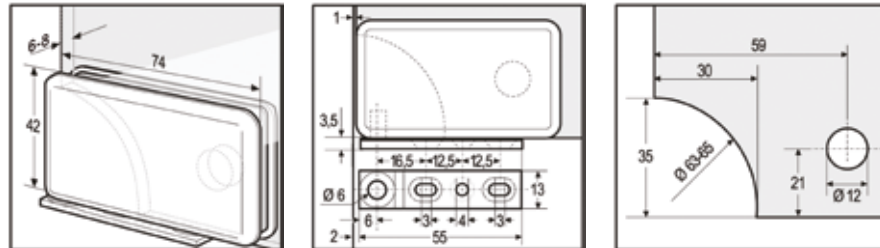

## ▶ Glass Door Hinge for Inset Doors



Please allow upper and lower gap distances of 3 mm and a lateral gap of 2.8 mm

**i** Glass thickness max. 5.2 mm · Door size max. 1000 x 500 mm · Opening angle 105° · Finish matt nickel-plated · without glass processing

Art. No.	
BO 5205281	Glass Door Hinge

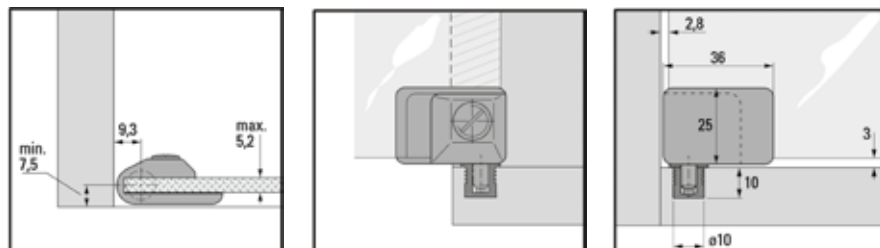

## ▶ Hinged Clip for Glass Doors

For inset doors · to clamp glass panels · can be used on the right or left side · with bush made of brass



**i** Door weight per pair max. 5 kg · Door size max. 400 x 600 mm · Size 35 x 15 mm · Glass thickness 4 - 6 mm · Material brass, chrome-plated · Packaging unit 1 pair

Art. No.	
BO 5200070	Hinged Clip for Glass Doors

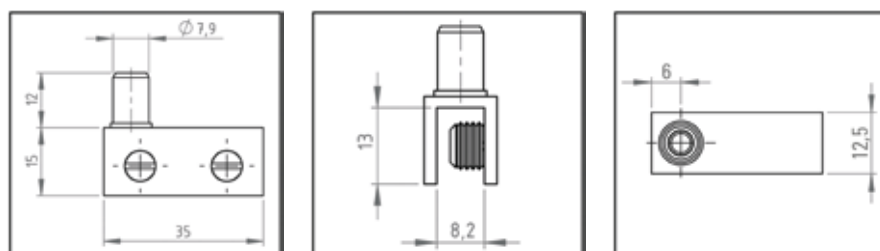

## Hinged Clip for Glass Doors

For inset doors · for clamping glass panels · can be used on the right or left side · with bush made of brass



**i** Door weight per pair max. 8 kg · Door size max. 500 x 800 mm · Size 40 x 27 mm · Glass thickness 6 - 8 mm · Material brass, chrome-plated · Packaging unit 1 pair

### Art. No.

BO 5200073	Hinged Clip for Glass Doors
------------	-----------------------------

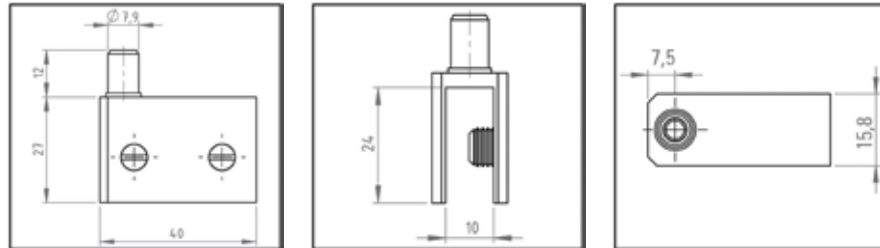

## Cristallo Fix Hinge Set



With Cristallo Fix, Bohle has developed a hinge which enables glass doors to be bonded to glass cabinets and which can also be adjusted in three dimensions. The technically sophisticated product with an opening angle of 125° is equipped with a damper with spring closing mechanism and is equally suitable for inset or overlay doors. Instead of a conventional cross plate mounting, this new product uses a cabinet bonding plate with snap-on function which was specifically developed for this purpose · infinitely adjustable · with integrated damping technology



**i** Mounting glass/glass · Opening angle 125° · Glass thickness 3 - 8 mm · for UV bonding

### Included in delivery:

1x Bonding Plate  
1x Hinge Arm  
1x Damper  
1x Bonding Plate

### Art. No. Description · Sales unit

BO 5206060	Cristallo Fix Hinge Set · 1 items
------------	-----------------------------------

## Cristallo Glass/Wood Hinge with Damping Mechanism or Cover Plate



The Cristallo hinge in the glass/wood version can be combined with damper system or cover plate · new damping technology · for inset or overlay glass doors · snap on/off function · cross mounting plate for wood

**i** Adjustment dimensions max. height / depth / width  $\pm 2 / 3 / 4$  mm · Mounting Glass/wood · Opening angle 125° · Load capacity see image in kg · for UV bonding

### Included in delivery:

1x Cross mounting plate  
1x Hinge Arm  
1x Damper  
1x Bonding Plate

### Art. No. Version

BO 5206068	Cristallo Glass/Wood Hinge with Damping Mechanism
------------	---

## ▶ Verifix® Glass Door Hinge 90°



This attractive hinge with stainless steel bonding plate can be used for inset glass doors with two hinges. Adjustable in three dimensions. Equipped with a self-closing spring mechanism, it is ideal for use with the dampers BO 5500230/31 and BO 5500235/36. Please be aware when opening the door that it swings approx. 30 mm to the inside. Trim shelves if necessary!

**i** Glass thickness 6 - 8 mm · Opening angle 90° · Maximum load capacity per pair 8 kg · Packaging unit 1 item · for UV bonding

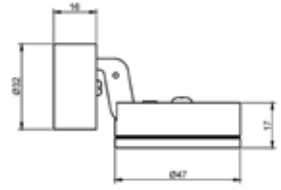

Art. No.	Description
----------	-------------

BO 5206200	Glass Door Hinge
------------	------------------

## ▶ Swing Hinge round



High quality stainless steel hinge suitable for inset doors - a threaded pin in the hinge enables the door to be removed after bonding

**i** For inset doors · Diameter 20 mm · Height 18.5 mm · Glass thickness up to 12 mm · Door weight max. 10 kg · Packaging unit 2 items · for UV bonding

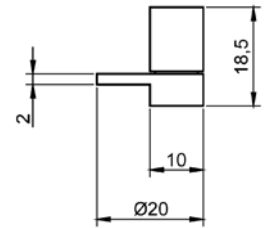

Art. No.	Description
----------	-------------

BO 5206260	Swing Hinge, round
------------	--------------------

# Glass Door Locks

## ▶ Glass Door Lock



Universal key · with 3 keys · key can only be removed when the lock is locked

**i** Glass thickness 6 - 8 mm · Material zinc, chrome-plated · with glass processing

Art. No.
----------

BO 5206311	Glass Door Lock
------------	-----------------

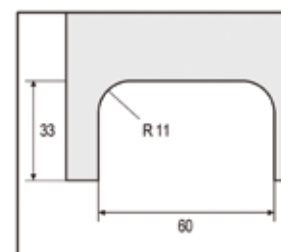
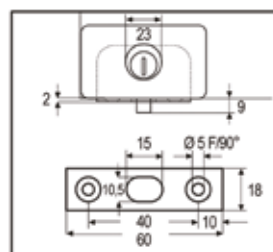
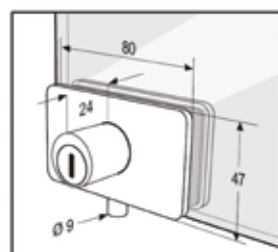

## ▶ Glass Door Lock / Cylinder Knob 6 mm

Downward closing direction



**i** Glass thickness 6 mm · Drill hole in glass  $\varnothing$  20 mm · Material zinc · with glass processing

Included in delivery:

- 1 Cylinder Knob
- 2 Square headed key
- 2 Rubber rings

Art. No.	Finish · Version · For
BO 5206340	matt nickel-plated · universal key · BO 5206365
BO 5206341	matt nickel-plated · individual key · BO 5206365
BO 5206342	shiny chrome-plated · universal key · BO 5206366
BO 5206343	shiny chrome-plated · individual key · BO 5206366
BO 5206344	matt chrome-plated · universal key · BO 5206367
BO 5206345	matt chrome-plated · individual key · BO 5206367

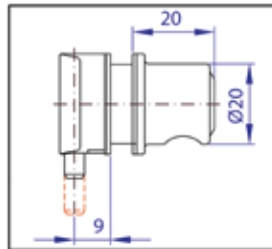
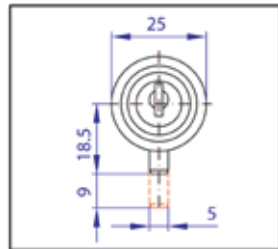

## ▶ Lock for Single Inset or Overlay Doors

For UV bonding · stainless steel · universal key · please indicate glass thickness when ordering · The lock is suitable for right and left handed doors as both bolt and lock cylinder can be turned around by loosening the screw.



**i** Diameter 35 mm · Glass thickness 6 - 15 mm · Drill hole in glass  $\varnothing$  25 mm · Packaging unit 1 item

Art. No.	Description
BO 5206240	Lock for Single Inset or Overlay Doors

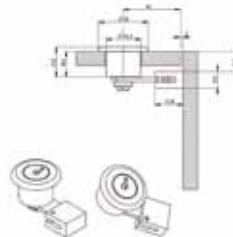
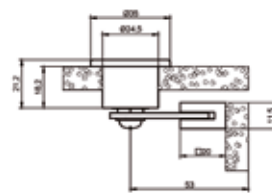



# Glass Door Handles

## ▶ Doorknob for Glass Doors

Made of brass · with M4 Phillips screw



❗  $\varnothing$  15 mm · Handle length 22 mm · Glass thickness 4 - 8 mm · Drill hole in glass  $\varnothing$  5 mm

Art. No.	Finish
BO 5206221	polished brass
BO 5206222	brass, matt nickel-plated
BO 5206223	shiny chrome-plated

## ▶ Glass Door Handle, One-Sided

For bonding into sliding doors



❗  $\varnothing$  55 mm · Drill hole in glass  $\varnothing$  40 mm · Material brass

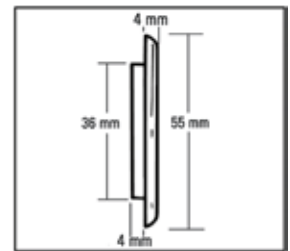

Art. No.	Finish
BO 5205102	chrome-plated

## ▶ Door Knob, Stainless Steel



❗ Diameter 16 mm · Length 20 mm · Packaging unit 2 items · for UV bonding

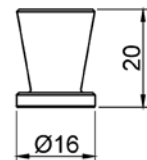

Art. No.	Description
BO 5206256	Door Knob, Stainless Steel

# Showcase Shelf Supports

## ▶ Glass Shelf Support



**i** Width Glass Shelf Support 30 mm · Glass thickness 6 - 10 mm · Projection maximum 160 mm · Width maximum 600 mm · Load capacity per pair max. 5 kg · without glass processing

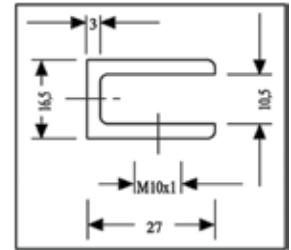

Art. No.	Finish
BO 5206900	stainless steel V4A
BO 5206901	chrome-plated
BO 5206904	matt chrome-plated

## ▶ Glass Shelf Support



With larger bearing surface · with steel holding screw

**i** Width Glass Shelf Support 30 mm · Glass thickness 6 - 10 mm · Projection maximum 200 mm · Width maximum 600 mm · Load capacity per pair max. 10 kg · without glass processing

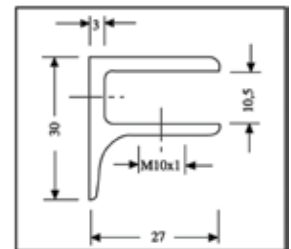

Art. No.	Finish
BO 5206905	chrome-plated
BO 5206906	matt chrome-plated
BO 5206908	stainless steel V4A

## ▶ Glass Shelf Support



With steel holding screw

**i** Width Glass Shelf Support 50 mm · Glass thickness 6 - 10 mm · Projection maximum 200 mm · Width maximum 600 mm · Load capacity per pair max. 5 kg · Shape D-shaped · without glass processing

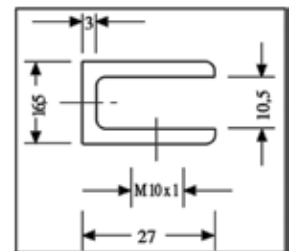

Art. No.	Finish
BO 5207200	stainless steel V4A
BO 5207201	chrome-plated
BO 5207204	matt chrome-plated

## ▶ Borosilicate Glass Discs



Ground plane-parallel · centre with laser mark · suitable as shelf support or furniture foot

**i** Thickness 10 mm · Max. load capacity per 4 pieces 40 kg · Packaging unit 20 items · for UV bonding

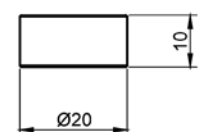

Art. No.	Description · Diameter
BO 5206190	Borosilicate Glass Discs · 20 mm
BO 5206110	Borosilicate Glass Discs · 10 mm

# Vitris supra Fittings for Sliding Showcase Doors



## Features

- Modular system
- Long-lasting function
- High level of security
- Simple to install
- Low stock requirements

## ▶ Vitris supra Fittings for Sliding Showcase Doors



Supra is a versatile sliding door fittings system for glass thicknesses of 4, 5, 6 and 8 mm. The high quality flocking of the top twin guides, the superior roller technology, the secure combination of glass and metal through transparent plastic bedding profiles as well as the invisibly integrated damping and anti-theft devices provide for the perfect, long-lasting, easy and quiet functioning of the glass sliding doors. It can be used in a range between 25 kg (2 rollers) and 50 kg (4 rollers).

# Glass Deduction and Profile Calculations

supra

Glass deduction = installation height - 32 mm  
(Bedding Profile not included)

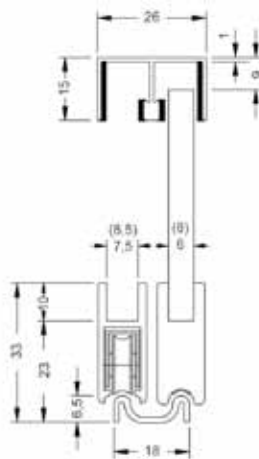

supra with frame profile

Glass deduction = installation height - 41 mm  
(Bedding Profile not included)

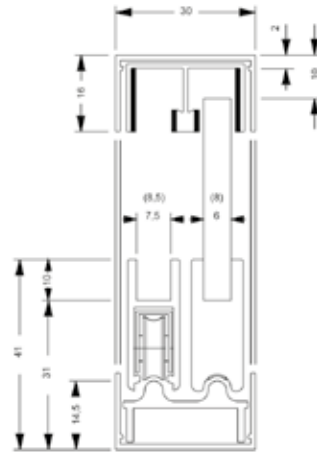

supra with triple track fittings

Glass deduction = installation height - 32 mm  
(Bedding Profile not included)

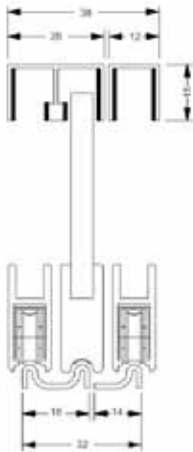

Calculation of glass dimensions:  $((L-22 + \text{overlap}):2)$

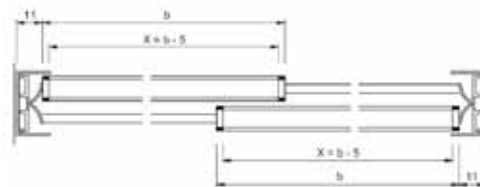

Calculation of glass dimensions:  $((L-22 + \text{overlap}):2)$

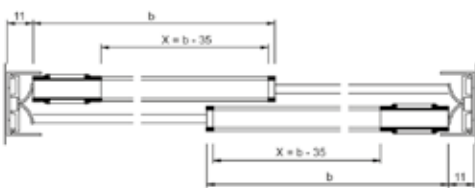

Calculation of glass dimensions:  $b = ((L - 22 + 32) : 2)$

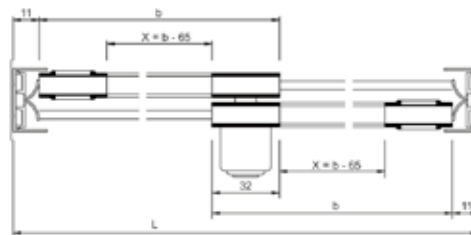

L = clear opening  
x = length of roller profile  
b = door width/glass dimensions  
Overlap: 32 mm



## Slide Rail 4 - 6 mm



**i** Version supplied with protective film · Glass thickness 4 - 6 mm · Length 5 m · Material aluminium

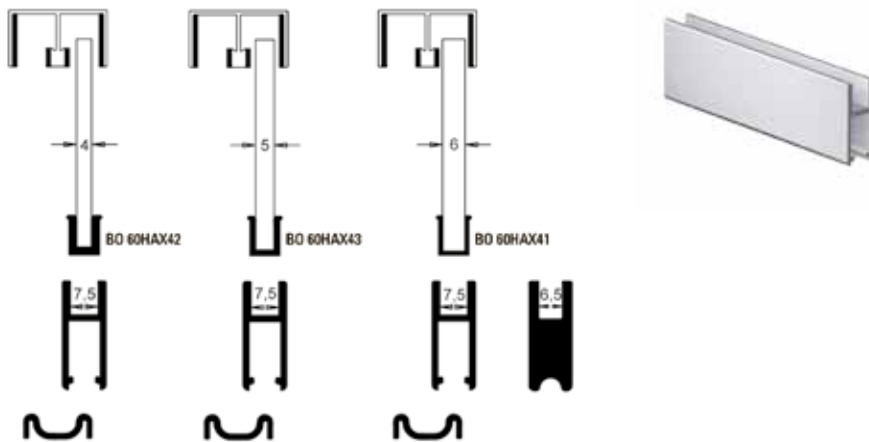

Art. No.	Finish
BO 60HAX31	plain anodised



## Slide Rail 5 - 8 mm



**i** Version supplied with protective film · Glass thickness 5 - 8 mm · Length 5 m · Material aluminium

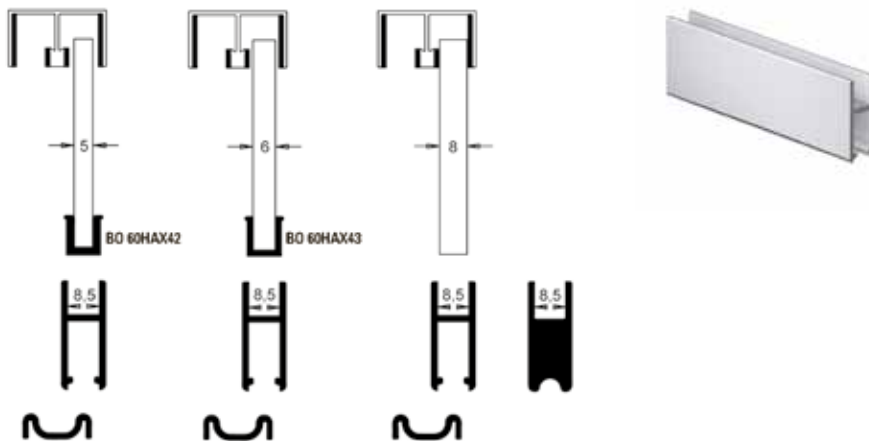

Art. No.	Finish
BO 60HAX80	plain anodised



## Double Track bottom



**i** Version with double-sided adhesive tape · Glass thickness 4 - 8 mm · Length 5 m · Material aluminium

Art. No.	Finish
BO 60HAX35	plain anodised



## Top Twin Guide



**i** Version flocked · Protected by foil · Glass thickness 4 - 8 mm · Length 5 m · Material aluminium

Art. No.	Finish
BO 60HAX30	plain anodised



## Wheel Unit



**i** Version with steel ball bearing roller · Finish plastic covered · Material galvanised spring steel housing · Max. load capacity for 2 wheel units 25 kg · Max. load capacity for 4 wheel units 50 kg

Art. No.	
BO 60HAX34	Wheel Unit



## End Plate 4 - 6 mm

For slide rail BO 60HAX31/61



**i** Version with cut-out · Glass thickness 4 - 6 mm · Material plastic

Art. No.	Finish
BO 60HAX32	aluminium



## End Plate 5 - 8 mm

For slide rail BO 60HAX80/82



**i** Version with cut-out · Glass thickness 5 - 8 mm · Material plastic

Art. No.	Finish
BO 60HAX81	aluminium

## Accessories for vitris supra

### ▶ Frame Profile XXL



**i** Version supplied with protective film · Glass thickness 4 - 8 mm · Length 5 m · Material aluminium

Art. No.	Finish
BO 60HAX36	plain anodised

### ▶ Dust Protection and Damping Insert XXL



For frame profiles BO 60HAX36/63 and BO 60HAX109

**i** Length 5 m · Finish transparent · Material plastic

Art. No.	
BO 60HAX38	Dust Protection and Damping Insert

### ▶ Bedding Profile 6 mm



For 6 mm glass in slide rail BO 60HAX31/61 with 7.5 mm groove width

**i** Glass thickness 6 mm · Finish transparent · Material plastic · Sales unit 1 m

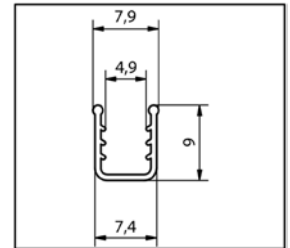

Art. No.	
BO 60HAX41	Bedding Profile

### ▶ Bedding Profile 5 + 6 mm



For 5 mm glass in slide rail BO 60HAX31/61 with 7.5 mm groove width · for 6 mm glass in slide rail BO 60HAX80/82 with 8.5 mm groove width

**i** Glass thickness 5 + 6 mm · Finish transparent · Material plastic · Sales unit 1 m

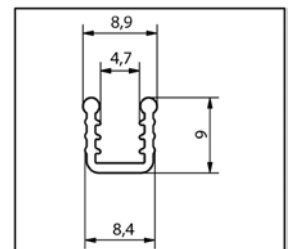

Art. No.	
BO 60HAX43	Bedding Profile

## ▶ Bedding Profile 4 + 5 mm



For 4 mm glass in slide rail BO 60HAX31/61 with 7.5 mm groove width ·  
for 5 mm glass in slide rail BO 60HAX80/82 with 8.5 mm groove width

**i** Glass thickness 4 + 5 mm · Finish transparent · Material plastic ·  
Sales unit 1 m

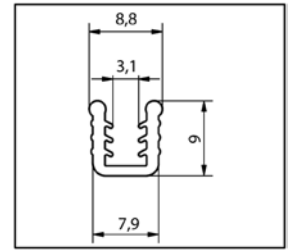

### Art. No.

BO 60HAX42	Bedding Profile
------------	-----------------

## ▶ Vibration Damper and Anti-theft Device



**i** Version for double guide profiles · Glass thickness 4 - 6 mm · Finish transparent · Material plastic

### Art. No.

BO 60HAX45	Vibration Damper and Anti-theft Device
------------	--

## ▶ Damping and Anti-theft Device



**i** Version for double guide profiles · Glass thickness 4 - 8 mm · Finish transparent · Material plastic

### Art. No.

BO 60HAX47	Damping and Anti-theft Device
------------	-------------------------------

## ▶ Finger Pull Handle



**i** Version can be used on left or right side · Glass thickness 4 - 8 mm · Material plastic

### Art. No.

### Finish

BO 60HAX48	aluminium
------------	-----------

## ▶ Security Lock for Door Shoe



Key number: 1075

**i** Version universal key · In combination with frame profile BO 60HAX36, please use the lock BO 60HAX56.

### Art. No.

### Finish

BO 60HAX119	chrome-plated
-------------	---------------





## Keep for Security Lock



**i** Version can be used on left or right side · Glass thickness 4 - 8 mm · Material zinc

Art. No.	Finish
BO 60HAX50	chrome-plated



## Finger Pull Handle self-adhesive



**i**  $\varnothing$  44 mm · Version closed · Finish matt stainless steel · Mounting single sided, self-adhesive · Glass processing none

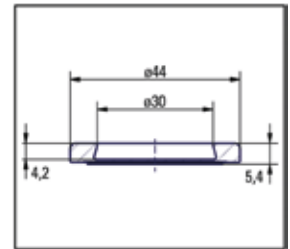

Art. No.	Name
BO 5205106	Finger Pull Handle

# Point Fixings and Standoffs

## ▶ Holder · Stainless Steel



High-quality materials and workmanship · for use in a wide variety of applications · easy assembly · timeless elegance in stainless steel · safe and easy mounting with Allen screw · incl. plastic washers, screw, plugs and Allen key

**i** Head flat ·  $\varnothing$  13 mm · Drill hole in glass  $\varnothing$  9 mm · Wall distance 20 mm · Glass thickness 5 - 8 mm · Packaging unit 4 items

Art. No.

BO 5206172

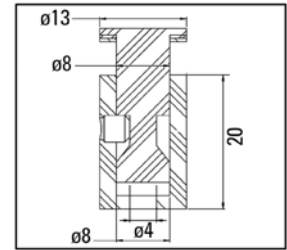

## ▶ Holder · Stainless Steel



High-quality materials and workmanship · for use in a wide variety of applications · easy assembly · timeless elegance in stainless steel · safe and easy mounting with Allen screw · incl. plastic washers, screw, plugs and Allen key

**i** Head flat ·  $\varnothing$  18 mm · Drill hole in glass  $\varnothing$  9 mm · Wall distance 20 mm · Glass thickness 5 - 8 mm · Packaging unit 4 items

Art. No.

BO 5206175

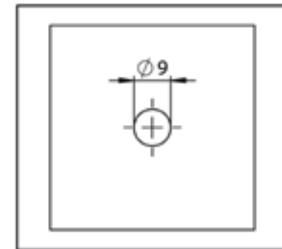
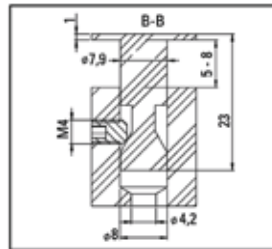
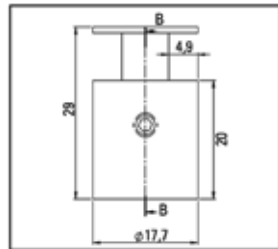

## ▶ GM PICO



For flush mounting of mirror or glass elements indoors · incl. nickel-plated cover cap (stainless steel look) · minimum distance from glass edge to centre of drill hole: float glass and mirrors: min. 20 mm; tempered glass: 2 x glass thickness + 10 mm · Suitable fixing screw BO 5211153

**i** Load capacity per support 5 kg

Art. No. Panel thickness · Colour

BO 5206010 6-8 mm · black

BO 5206011 6-8 mm · transparent

BO 5206012 10-12 mm · black

BO 5206013 10-12 mm · transparent

**Please note:**  
Flush supports are not suitable for overhead glazing!

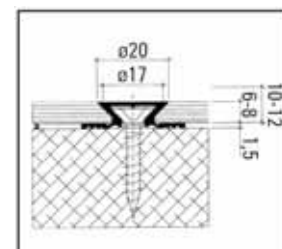
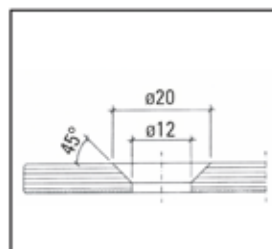
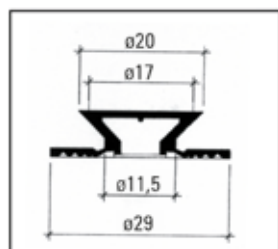



# 07

# Glass Railing Systems

## Bohle EasyMount *Vario* Glass Railing System

The EasyMount *Vario* Glass Mounting Kits enable quick and easy installation. With a simple sliding movement the system can be adjusted by up to 40 mm. The Bohle mounting tool BO 5215281 enables you to work from the accessible side, making installation less time consuming.

### Slender and Elegant Design

- absolute transparency
- unlimited installation lengths

### Simple Installation and Profitability

- Thanks to its unique load distribution, suitable for laminated safety glass already starting from 12.76 mm
- Saves time during mounting compared to other systems
- Quick and simple installation from only one side
- No cut-outs or drill holes in the glass required





### Individual Solutions

- Versatile compensation possibilities for up to  $\pm 20$  mm vertically
- Simplified planning - self-explanatory drawings to be found in the Online Shop. CAD and PDF files available upon request
- Great variety of profile types for almost every construction project and every application.
- Water drainage openings in profiles
- Flush profile extensions via connecting pins
- Anodised  $25\mu$  coating, salt water resistant
- Length of aluminium materials 2500 mm and 5000 mm
- We are happy to assist you when planning larger projects

### Certified Safety

- "General Building Inspection Test Certificate" (AbP)
- British Standards



				
	Top	Top L	Side	Side L
Top mount	✓			
Top mount with extended fixing plate		✓		
Side mount			✓	
Side mount with extended fixing plate				✓
Rail load (kN)	1.0*	1.0*	1.0*	1.0*
Length (mm)	2500 / 5000	2500 / 5000	2500 / 5000	2500 / 5000

\* You will find profile for 2.0 (3.0) kN at [www.bohle-group.com](http://www.bohle-group.com)

# Bohle EasyMount Top, 1.0 kN top mount

## ▶ Profile for EasyMount Top top mount



**i** Rail load 1.0 kN · Material aluminium

Art. No.	Length · Distance · Height · Finish
BO 5215228	2500 mm · (A) 50 mm · 120 mm · anodised E6/EV1
BO 5215390	5000 mm · (A) 25 mm · 120 mm · anodised E6/EV1

**Please note:**  
You will find suitable mounting kits under Bohle EasyMount Glass Mounting Kits.

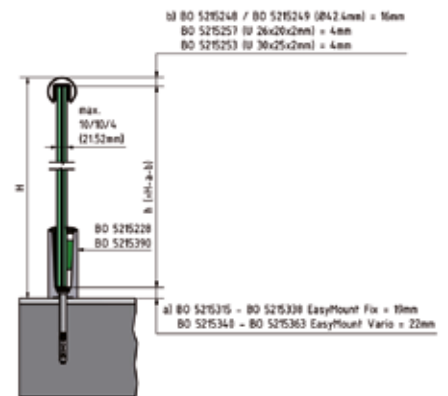
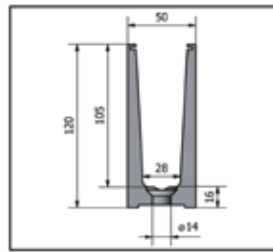
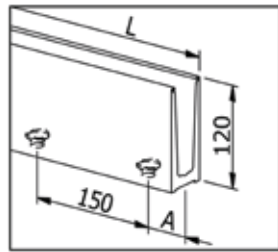

## ▶ End Stop



**i** Version left / right

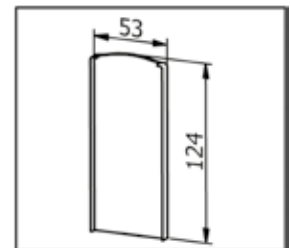

Art. No.	For · Finish
BO 5215230	Profile BO 5215228 / 5215390 - anodised E6/EV1

# Bohle EasyMount Top *Vario*, 1.0 kN top mount

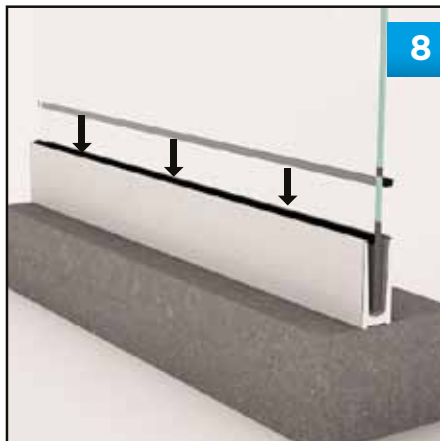
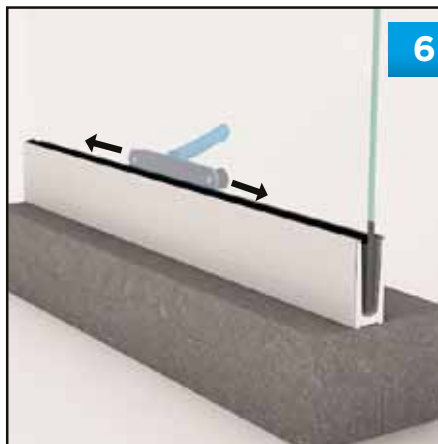
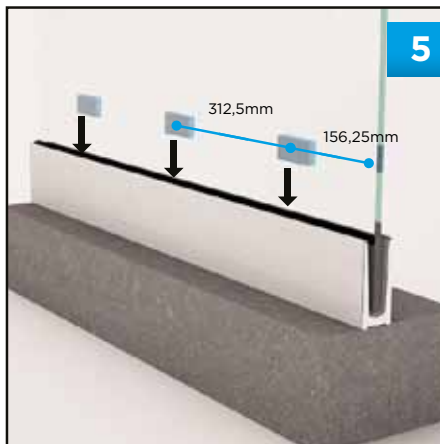
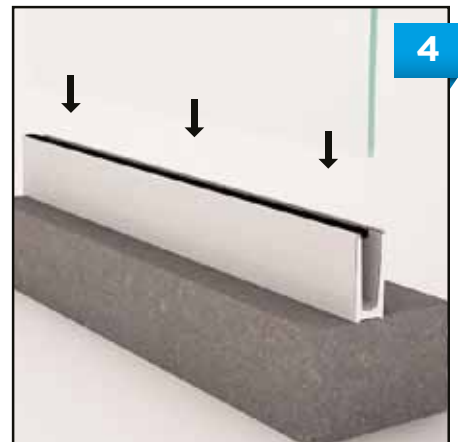
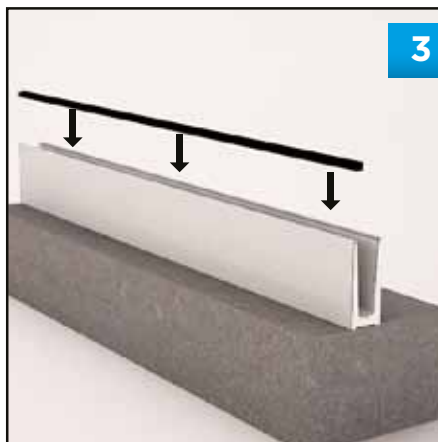
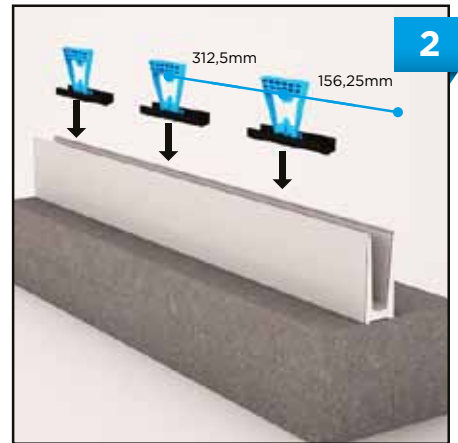
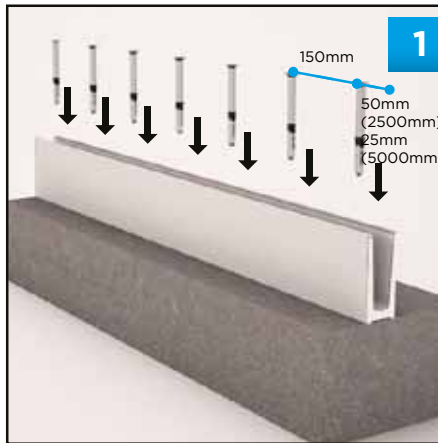

# Bohle EasyMount Top L, 1.0 kN top mount with extended fixing plate

## ▶ Profile for EasyMount Top L top mount with extended fixing plate



**i** Rail load 1.0 kN · Material aluminium

Art. No.	Length · Distance · Height · Finish
BO 5215215	2500 mm · (A) 170 mm · 120 mm · anodised E6/EV1
BO 5215384	5000 mm · (A) 160 mm · 120 mm · anodised E6/EV1

**Please note:**  
You will find suitable mounting kits under Bohle EasyMount Glass Mounting Kits.

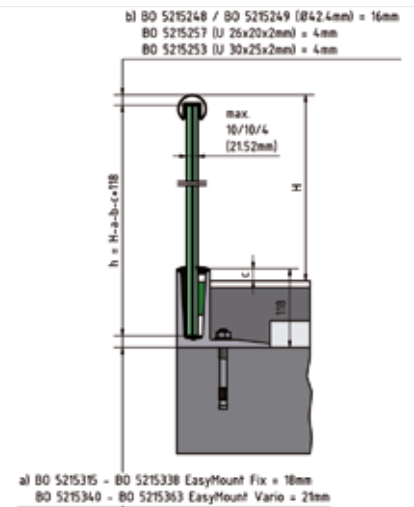
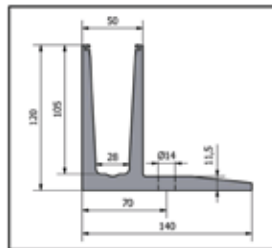
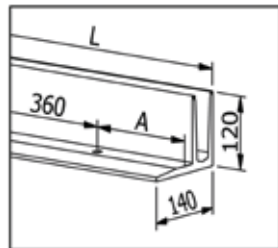

## ▶ End Pieces



**i** For profiles BO 5215215 / 5215384

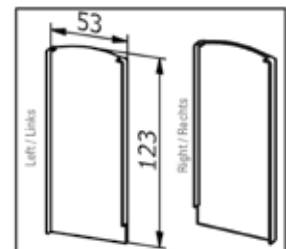

Art. No.	Version · For · Finish
BO 5215218	left · profile BO 5215215 / 5215384 · anodised E6/EV1
BO 5215219	right · profile BO 5215215 / 5215384 · anodised E6/EV1

# Bohle EasyMount Top L *Vario*, 1.0 kN top mount with extended fixing plate

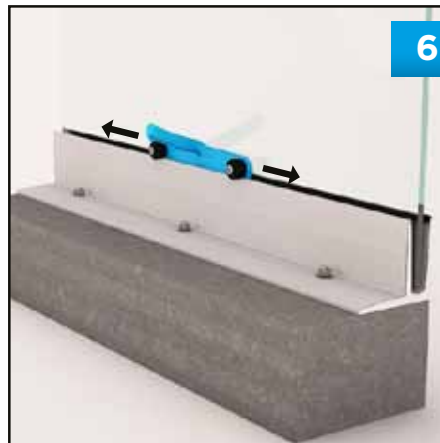
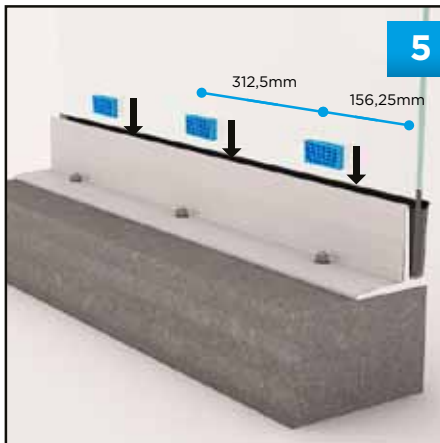
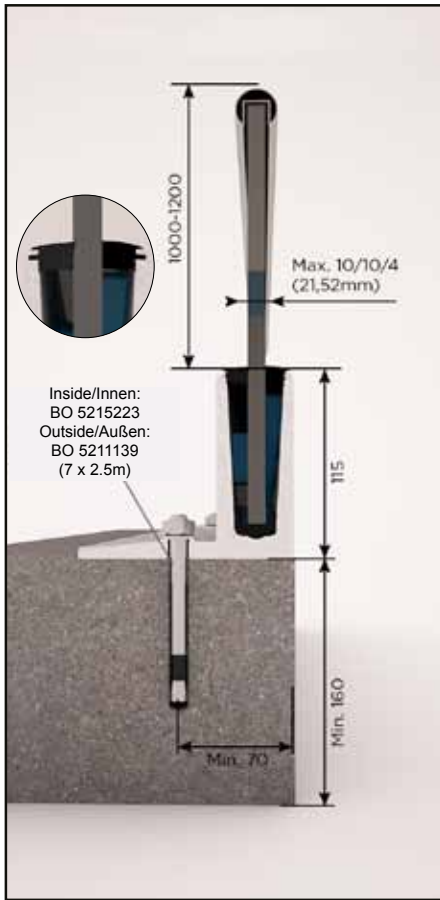



# Bohle EasyMount Side, 1.0 kN side mount

## Profile for EasyMount Side side mount



**i** Rail load 1.0 kN · Material aluminium

Art. No.	Length · Height · Finish
BO 5215233	2500 mm · 140 mm · anodised E6/EV1
BO 5215365	5000 mm · 140 mm · anodised E6/EV1

**Please note:**  
You will find suitable mounting kits under Bohle EasyMount Glass Mounting Kits.

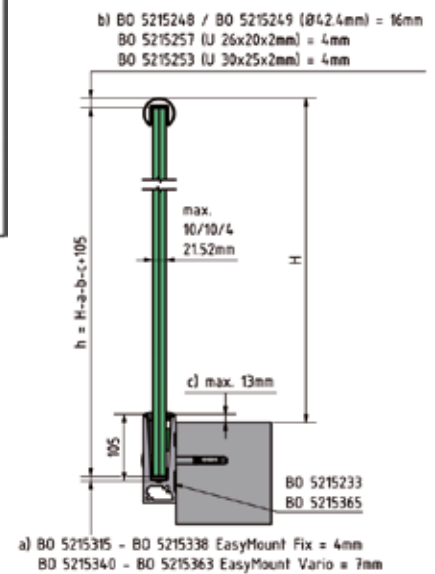
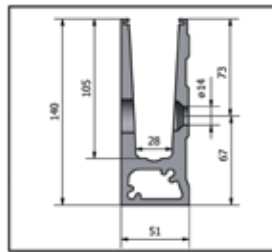
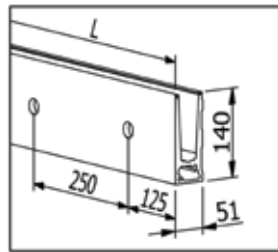

## Snapframe Standard

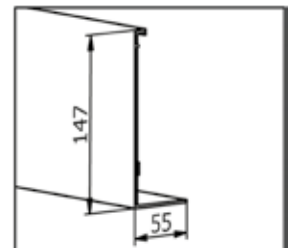

Art. No.	Length · For · Finish
BO 5215236	2500 mm · BO 5215233 · anodised E6/EV1
BO 5215371	5000 mm · BO 5215365 · anodised E6/EV1

## ▶ End Pieces



**i** For profiles BO 5215233 / 5215365

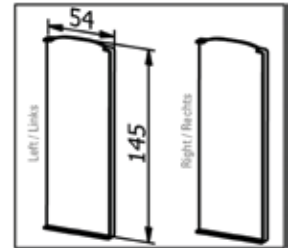

Art. No.	For · Version · Finish
BO 5215237	profile BO 5215233 / 5215365 · left · anodised E6/EV1
BO 5215238	profile BO 5215233 / 5215365 · right · anodised E6/EV1

## ▶ End Pieces for Use with Snapframe



**i** For profiles BO 5215233 / 5215365 with Snapframe

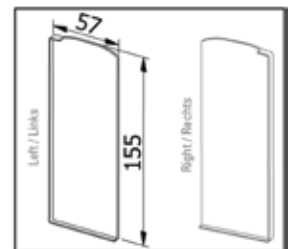

Art. No.	For · Version · Finish
BO 5215239	profile BO 5215233 / 5215365 · left · anodised E6/EV1
BO 5215240	profile BO 5215233 / 5215365 · right · anodised E6/EV1

## ▶ Extension Rod



For reinforcement of profile joints

**i** For profile BO 5215233, BO 5215365, BO 5215268 + BO 5215375 ·  $\varnothing$  6 mm · Length 40 mm · Material stainless steel (V4A) · Sales unit 8 items

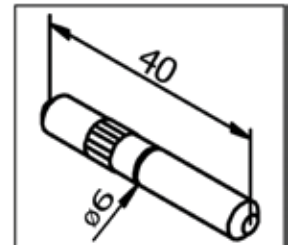

Art. No.
BO 5215244

## ▶ Caps



**i** For profile BO 5215233-35, BO 5215365-68 · Shape round ·  $\varnothing$  25 mm · Packaging unit 10 items

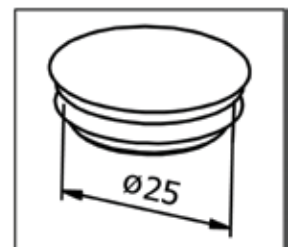

Art. No.
BO 5215245

# Bohle EasyMount Side *Vario*, 1.0 kN side mount

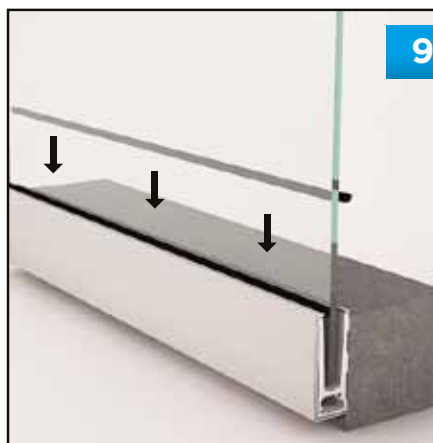
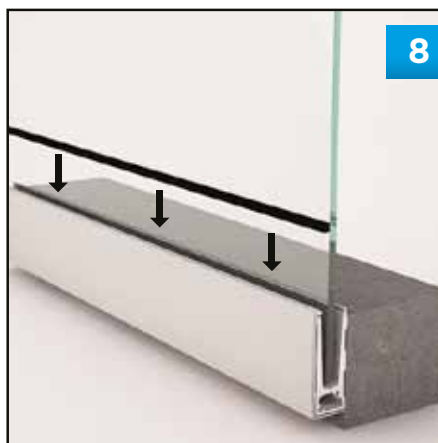
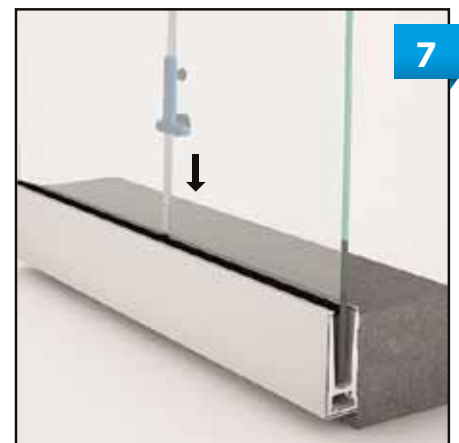
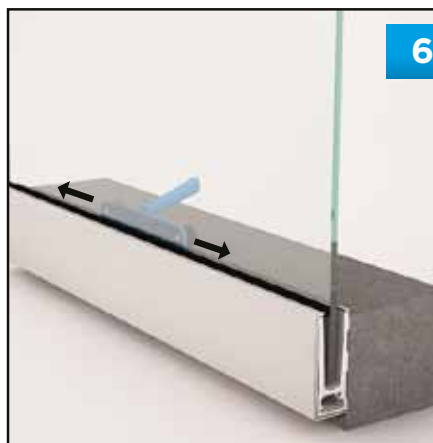
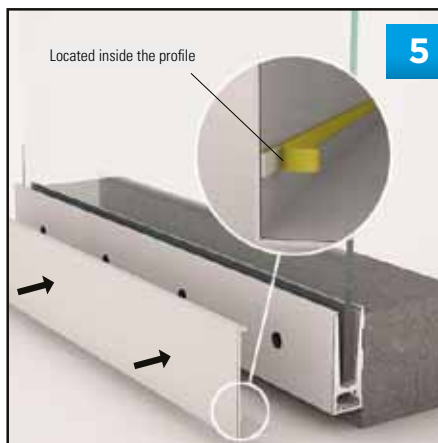
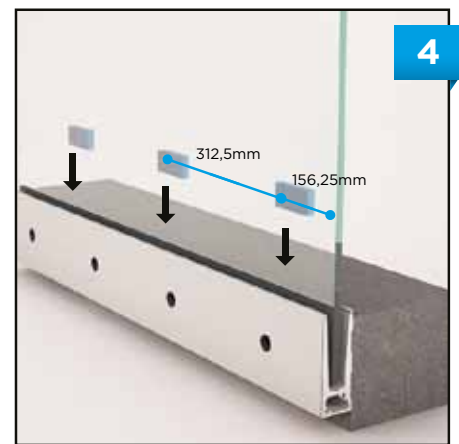
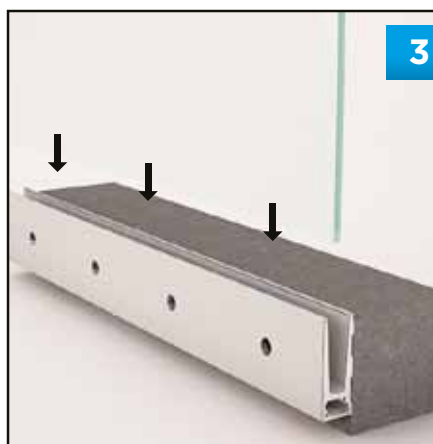
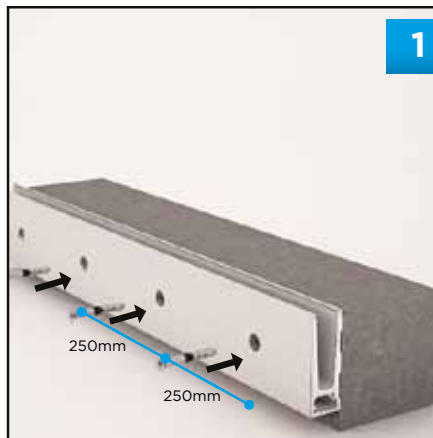
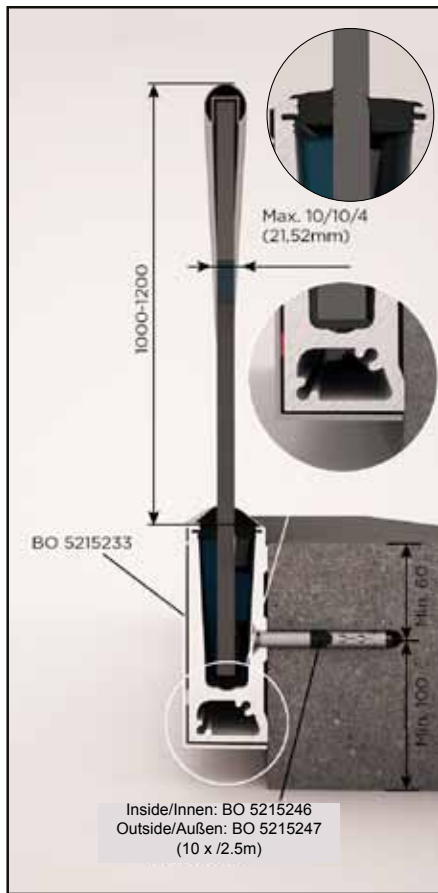

# Bohle EasyMount Side L, 1.0 kN side mount with extended fixing plate

## ▶ Profile for EasyMount Side L side mount with extended fixing plate



**i** Rail load 1.0 kN · Material aluminium

Art. No.	Length · Distance · Height · Finish
BO 5215268	2500 mm · (A) 140 mm · 210 mm · anodised E6/EV1
BO 5215375	5000 mm · (A) 95 mm · 210 mm · anodised E6/EV1

**Required accessories:**  
 Mounting block  
 BO 5215267, extension  
 rod BO 5215244

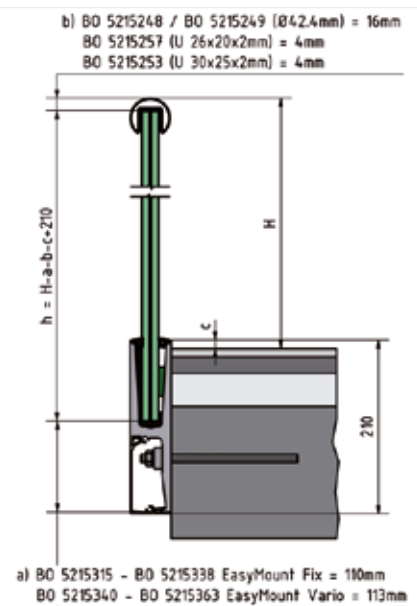
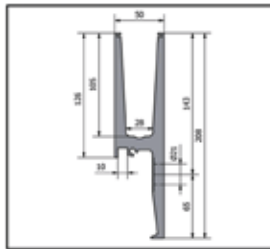
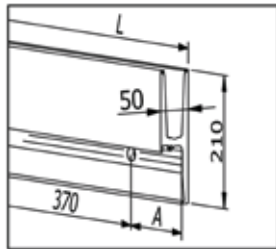

## ▶ Snapframe Standard



**i** Material aluminium

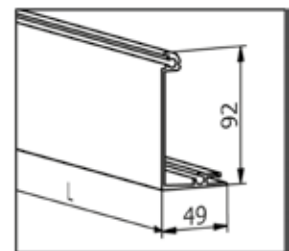

Art. No.	Description · Length · For · Finish
BO 5215271	Snapframe Standard · 2500 mm · BO 5215268 · anodised E6/EV1
BO 5215381	Snapframe Standard · 5000 mm · BO 5215375 · anodised E6/EV1
BO 5215282	End pieces left for profiles BO 5215268/75 · anodised E6/EV1
BO 5215283	End pieces right for profiles BO 5215268/75 · anodised E6/EV1



## Extension Rod



For reinforcement of profile joints

**i** For profile BO 5215233, BO 5215365, BO 5215268 + BO 5215375 ·  $\varnothing$  6 mm · Length 40 mm · Material stainless steel (V4A) · Sales unit 8 items

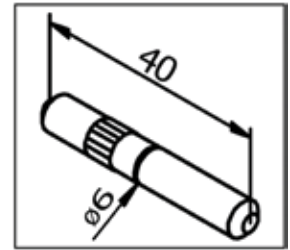

Art. No.

BO 5215244



## Mounting Block



**i** For profile BO 5215268-70, BO 5215375-78 · Material aluminium · Packaging unit 8 items

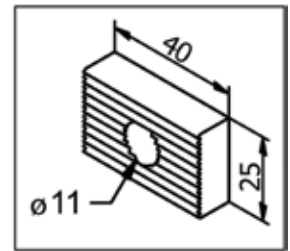

Art. No.

BO 5215267

# Bohle EasyMount Side L *Vario*, 1.0 kN side mount with extended fixing plate

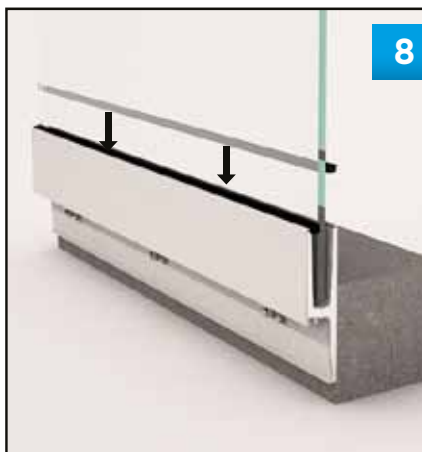
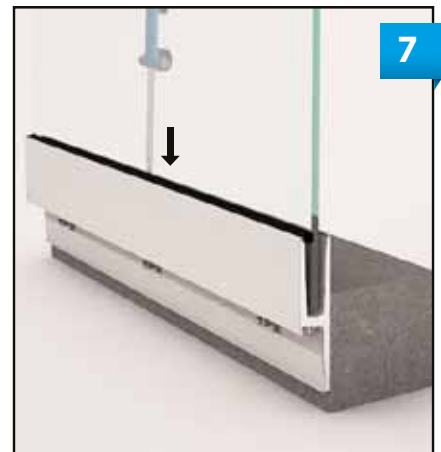
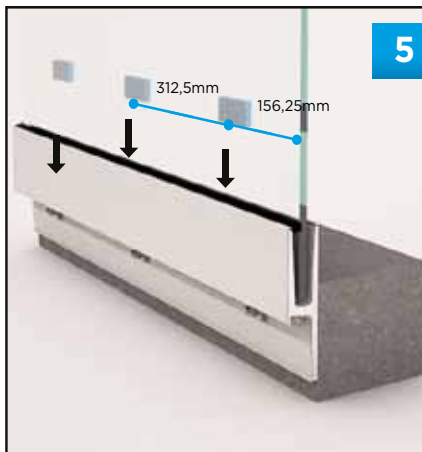
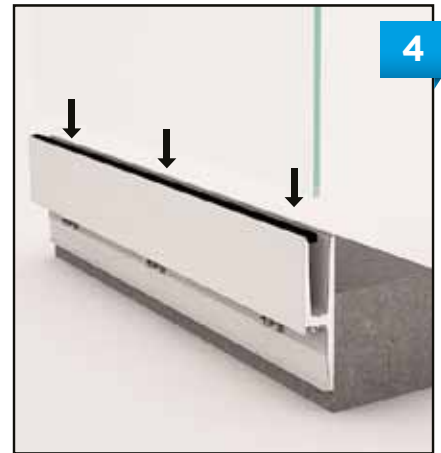
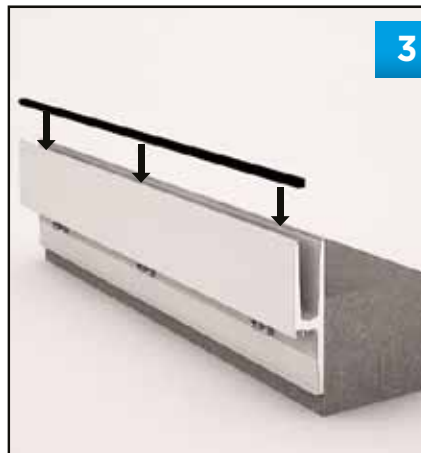
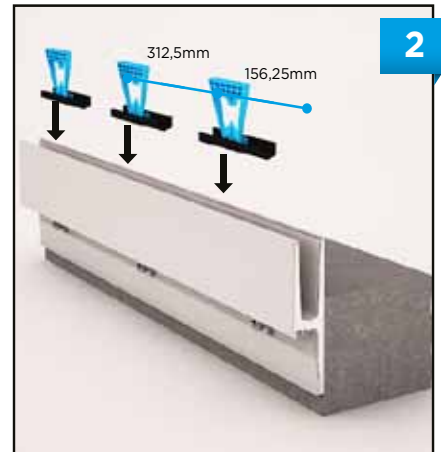
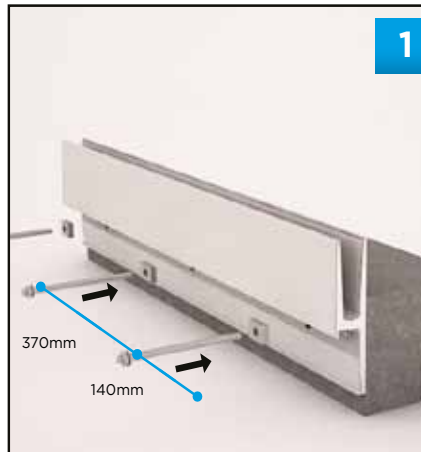
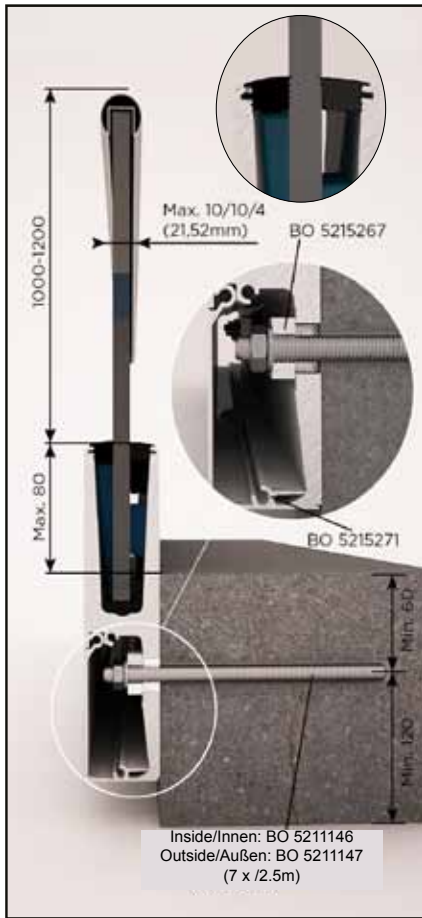

# Bohle EasyMount *Vario* Glass Mounting Kits

## ▶ EasyMount *Vario* Glass Mounting Kit Rail load 1.0 kN



EasyMount *Vario* - for linear alignment

**i** For profile 2500 mm

Included in delivery:  
2 x 2500 mm Rubber Profile  
8 x Glass clamps

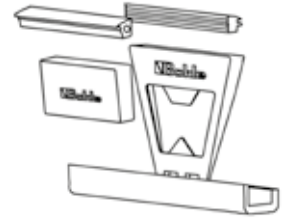

Art. No.	Glass thickness
BO 5215340	12 mm
BO 5215341	6/2/6 (12.76) mm
BO 5215342	6/4/6 (13.52) mm
BO 5215343	(19/32 in) 15 mm
BO 5215344	8/2/8 (16.76) mm
BO 5215345	8/4/8 (17.52) mm
BO 5215346	19 mm
BO 5215347	10/2/10 (20.76) mm
BO 5215348	10/4/10 (21.52) mm

## ▶ EasyMount *Vario* Glass Mounting Kit Rail load 1.0 kN



EasyMount *Vario* - for linear alignment

**i** For profile 5000 mm

Included in delivery:  
2 x 5000 mm Rubber Profile  
16 x Glass clamps

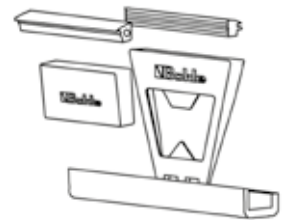

Art. No.	Glass thickness
BO 5215352	12 mm
BO 5215353	6/2/6 (12.76) mm
BO 5215354	6/4/6 (13.52) mm
BO 5215355	(15 mm) 19/32 mm
BO 5215356	8/2/8 (16.76) mm
BO 5215357	8/4/8 (17.52) mm
BO 5215358	19 mm
BO 5215359	10/2/10 (20.76) mm
BO 5215360	10/4/10 (21.52) mm

## ▶ Mounting Tool for Bohle EasyMount *Vario*

Mounting tool for Bohle EasyMount Vario= balustrade system



Art. No.

BO 5215284

## ▶ Handrail



Please use the following profiles with this handrail: BO 5215254 - BO 5215256.  
· Tested according to DIN 18008, part 4



**i** Shape U-Profile · Width (B) 30 mm · Material thickness 2 mm · Height (H) 25 mm · Inside (U) 26 mm · Length 4000 mm

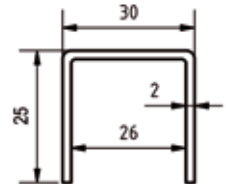

Art. No.

Material

BO 5215253

stainless steel V2A

## ▶ Rubber Profile



**i** For Handrail BO 5215253 · Shape U-Profile · Length 4000 mm

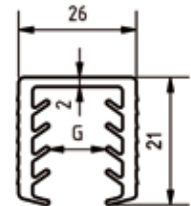

Art. No.

Glass thickness

BO 5215254

11.5 - 13.5 mm

BO 5215255

16 - 17.5 mm

BO 5215256

20 - 21.5 mm





Single point fixing

# Single point fixing

## Single Point Fixings 50 mm

For tempered and laminated safety glass · use at least 4 pieces depending on glass dimensions · Diagrams for glass processing can be found in our Online Shop · Can be adjusted through elongated hole in connection element.

**i** Size  $\varnothing$  50 · Drill hole in glass 30 mm  $\varnothing$  · Adjustment range 0 - 5 mm

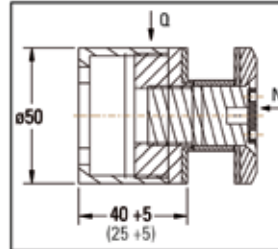

### Features

Easy installation and fixing of the glass · Sturdy design in accordance with DIN EN 1991-1-1 · High precision and quality finish · Possibility of customised versions

Art. No.	Adjustable mounting distance glass/wall · Glass thickness · Stainless steel · Max. load bearing capacity
BO 5214026	25 mm · tempered glass 10 - 12 mm · laminated safety glass 11.52 - 13.52 mm · AISI 304 · Q: 3.5; N: 6.0 kN
BO 5214027	40 mm · tempered glass 10 - 19 mm · laminated safety glass 11.52 - 21.52 mm · AISI 304 · Q: 3.5; N: 5.0 kN
BO 5214034	25 mm · tempered glass 15 - 19 mm · laminated safety glass 17.52 - 21.52 mm · AISI 304 · Q: 4.0; N: 6.0 kN
BO 5214028	25 mm · tempered glass 10 - 12 mm · laminated safety glass 11.52 - 13.52 mm · AISI 316 · Q: 4.0; N: 6.0 kN
BO 5214029	40 mm · tempered glass 10 - 19 mm · laminated safety glass 11.52 - 21.52 mm · AISI 316 · Q: 3.5; N: 5.0 kN
BO 5214035	25 mm · tempered glass 15 - 19 mm · laminated safety glass 17.52 - 21.52 mm · AISI 316 · Q: 4.0; N: 6.0 kN

## ▶ Single Point Fixings 40 mm

For tempered and laminated safety glass · use at least 4 pieces depending on glass dimensions · Diagrams for glass processing can be found in our Online Shop · Can be adjusted through elongated hole in connection element.

❗ Size  $\varnothing$  40 · Drill hole in glass 25 mm  $\varnothing$  · Adjustment range 0 - 5 mm

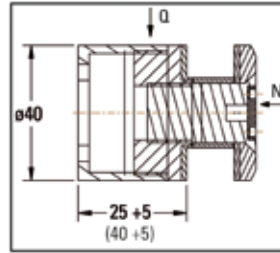

### ▼ Features

Easy installation and fixing of the glass · Adjustable from the front · Adjustment of distance is possible after the glass has been mounted · Sturdy design in accordance with DIN EN 1991-1-1 · High precision and quality finish · Possibility of customised versions

Art. No.	Adjustable mounting distance glass/wall · Glass thickness · Stainless steel · Max. load bearing capacity
BO 5214030	25 mm · tempered glass 10 - 12 mm · laminated safety glass 11.52 - 13.52 mm · AISI 304 · Q: 3.5; N: 5.5 kN
BO 5214031	40 mm · tempered glass 10 - 19 mm · laminated safety glass 11.52 - 21.52 mm · AISI 304 · Q: 3.0; N: 4.5 kN
BO 5214036	25 mm · tempered glass 15 - 19 mm · laminated safety glass 17.52 - 21.52 mm · AISI 304 · Q: 3.5; N: 5.5 kN
BO 5214032	25 mm · tempered glass 10 - 12 mm · laminated safety glass 11.52 - 13.52 mm · AISI 316 · Q: 3.5; N: 5.5 kN
BO 5214033	40 mm · tempered glass 10 - 19 mm · laminated safety glass 11.52 - 21.52 mm · AISI 316 · Q: 3.0; N: 4.5 kN
BO 5214037	25 mm · tempered glass 15 - 19 mm · laminated safety glass 17.52 - 21.52 mm · AISI 316 · Q: 3.5 N: 5.5 kN

## ▶ Mounting Tool Single Point Fixings

For single point fixings BO 5214026 - 37



Art. No.	Version
BO 5214038	For single point fixing 40 mm
BO 5214041	For single point fixing 50 mm

# Key Word Index

## A

Adhesive Bonding Tapes Bohle Duplocoll®	66
Aqua Shower Door Hinges	13

## B

Barcelona Select Shower Door Hinge	17
Barcelona Shower Door Hinge	15
Bella Shower Door Hinge	20
Bilbao Premium Shower Door Hinge	24
Bilbao Select Shower Door Hinge	16
Bilbao Shower Door Hinge	14
Bohle FrameTec Premium Frame System	54
Bohle FrameTec Select Frame System	51
Bohle Patch Corner Fitting System	49
Borosilicate Glass Discs	74

## C

Clamp-on Frame Profile for Wall Connection	65
Clamp-on Profile	52
Corner Clamp Barcelona	17
Corner Clamp Bella	21
Corner Clamp Bilbao Premium	24
Corner Clamp Bilbao Select	16
Corner Clamp Granada	23
Corner Clamp Madrid	19
Corner Clamp Milano Original	25
Corner Fitting System Bohle Patch	49
Cristallo Fix Hinge Set	70

## D

Door Handle	59
Doorknob for Glass Doors	73
Double Profile Cylinder	58
Drop Down Seals	57
Duplocoll® Adhesive Bonding Tapes	66

## E

EasyMount Side L side mount with extended fixing plate	92
EasyMount Side side mount	89
EasyMount Top L top mount with extended fixing plate	87
EasyMount Top top mount	85
EasyMount Vario Glass Mounting Kit	95
End cap set for U-profiles FrameTec Select	52
End caps for U-Channels	65
End Pieces EasyMount	85, 87, 90
Extension Rod	90, 93

## F

Finger Pull Handle self-adhesive	81
Flush Handle	62
Frame System Bohle FrameTec Premium	54
Frame System Bohle FrameTec Select	51
FrameTec Premium	54
FrameTec Select	51

## G

Glass Door Handle	73
Glass Door Hinge	59, 68, 71
Glass Door Latch	58
Glass Door Lock	58, 71
Glass Door Lock / Cylinder Knob	72
Glass Mounting Kit EasyMount Vario	95
Glass Shelf Support	74
Granada Shower Door Hinge	22

## H

Handle for All-Glass Doors	61
Handrail	96
Hinged Clip for Glass Doors	69
Holder	82
Hook Lock Bohle Patch	63

# K

Keep for Security Lock	81
------------------------	----

# L

Lateral Sealing Strip	28
-----------------------	----

# M

Madrid Shower Door Hinge	18
Milano Original Shower Door Hinge	25
Mounting Block	93
Mounting Tool for EasyMount Vario	96
Mounting Tool Single Point Fixings	99

# P

PICO	82
Profile for EasyMount Side L side mount with extended fixing plate	92
Profile for EasyMount Side side mount	89
Profile for EasyMount Top L top mount with extended fixing plate	87
Profile for EasyMount Top top mount	85

# R

Reinforcement Bar	29
Rubber Profile	96

# S

Sealing Set	52
Sealing Strip	27
Sealing Strip self-adhesive	28
Shower Door Hinge Barcelona	15
Shower Door Hinge Barcelona Select	17
Shower Door Hinge Bella	20
Shower Door Hinge Bilbao	14
Shower Door Hinge Bilbao Premium	24
Shower Door Hinge Bilbao Select	16

Shower Door Hinge Granada	22
Shower Door Hinge Madrid	18
Shower Door Hinge Milano Original	25
Shower Door Knob	30
Shower Sealing	28
Single Point Fixings	98
SlideTec optima 150	42
SlideTec optima 50	34
SlideTec optima 80	38
Sliding Glass Door Handle	62
Sliding Door System Portavant 80 automatic	45
Snapframe Standard	89, 92
Swing Hinge	71

# T

Telescopic Reinforcement Bar Bohle Basic round	29
--	----

# U

U-Channels	31, 64
Universal PVC Profile	66
U-Profile	51

# V

Vitris supra Fittings for Sliding Showcase Doors	75
--	----

# W

Water Deflector	27
-----------------	----

# How to contact Bohle

## Bohle AG

Bohle Online Shop [www.bohle-group.com](http://www.bohle-group.com)

If you don't have a contact person yet, dial

Phone	+49 2129 5568-0 for our reception
Fax	+49 2129 5568-201
E-Mail	<a href="mailto:export@bohle.de">export@bohle.de</a>
Collecting goods	D - 42781 Haan · Siemensstraße 1
Postal address	D - 42755 Haan · Postfach 101163

## Office hours

Monday to Thursday	8.00 am - 4.30 pm
Friday	8.00 am - 2.00 pm

## Collecting goods

Monday to Thursday	8.00 am - 3.00 pm
Friday	8.00 am - 12.00 am



# In regard to this catalogue

Our Terms and Conditions apply and can be downloaded in their respective up-to-date version on the Bohle website at [www.bohle-group.com](http://www.bohle-group.com).

With the printing of this catalogue, all previous catalogues and price lists, or parts thereof, are no longer valid. Our offers apply to retail, trade and industry. Technical specifications (dimensions, weights, materials, etc.) and other specifications (design, colour, etc.) are subject to change. The range of products can change during the time this catalogue is current. In particular, we reserve the right to remove individual products without prior notice. Please request further details from your Bohle contact person. Print-related colour variations are possible. Bohle AG is not liable for any printing or other errors and omissions in this catalogue. For many of the products protective rights such as patents, trademarks, design copyrights, etc. have been registered or are pending registration - also by third parties.

© Copyright by Bohle - This catalogue is protected in all parts (texts, photos, images etc.) by copyright. Any use outside the strict limits of copyright laws without written permission of Bohle AG is not permitted. This applies in particular to duplications, reprints, translations, microfilming as well as saving and processing in electronic systems.



## Germany

Head Office  
Bohle AG  
Dieselstraße 10  
D - 42781 Haan

T +49 2129 5568-0  
F +49 2129 5568-201

[export@bohle.de](mailto:export@bohle.de)  
[www.bohle-group.com](http://www.bohle-group.com)

## South Africa

Bohle Glass Equipment (Pty) Ltd.  
Unit 3, Graphite Industrial Park  
Fabriek Street,  
Strijdom Park 2125, Gauteng

T +27 11 792-6432  
F +27 11 793-5634

[info@bohle.co.za](mailto:info@bohle.co.za)  
[www.bohle-group.com](http://www.bohle-group.com)