

FITTINGS

for Bathrooms



Bohle's Bathroom World

You can tell ambitious bathroom design by the high-quality details, coherent design concepts and the particular focus on quality. Thanks to its 21-strong product range, Bohle offers the perfect shower door hinge, including accessories, for every design style and every budget. You will always find the right solution in our portfolio – ranging from unobtrusive via classy and elegant up to expressive – for your individual harmonious style collection.

Your benefits

- Our range of 21 different product designs
- The perfect solution for every design style and every budget
- Digital processing of dimensions in the Shower Configurator
- Professional technical advice from our customer consultants

Our Shower Configurator will be your perfect planning assistant. 3D models of shower cubicles can be created quickly and easily, and without any prior knowledge – all required cut-outs, fittings and accessory parts are indicated precisely. The Configurator does not only display what the finished product will look like, it also creates CAD drawings which can be directly forwarded to the glass supplier. Take the measure, enter, order – done!

Who we are

Glass is our passion. Founded in 1923 as a family business, Bohle Group is now represented by almost 400 employees at 15 locations in Germany and abroad. We are one of the world's leading developers, manufacturers and wholesalers of glass fittings, sliding door applications, tools, machinery and accessories for glass processing and glass finishing.

Our product range is precisely tailored to the respective customer groups from trade, industry and retail. Quality is the leading principle at Bohle – in every area. We live up to this principle, for example, by developing a large part of our products in-house and manufacturing them in Germany. We are committed to strict quality requirements to deliver only products with optimum quality to our customers.

Goodbye Notebook!

FREE!
The Bohle Shower Configurator
Try it today at www.bohle.com

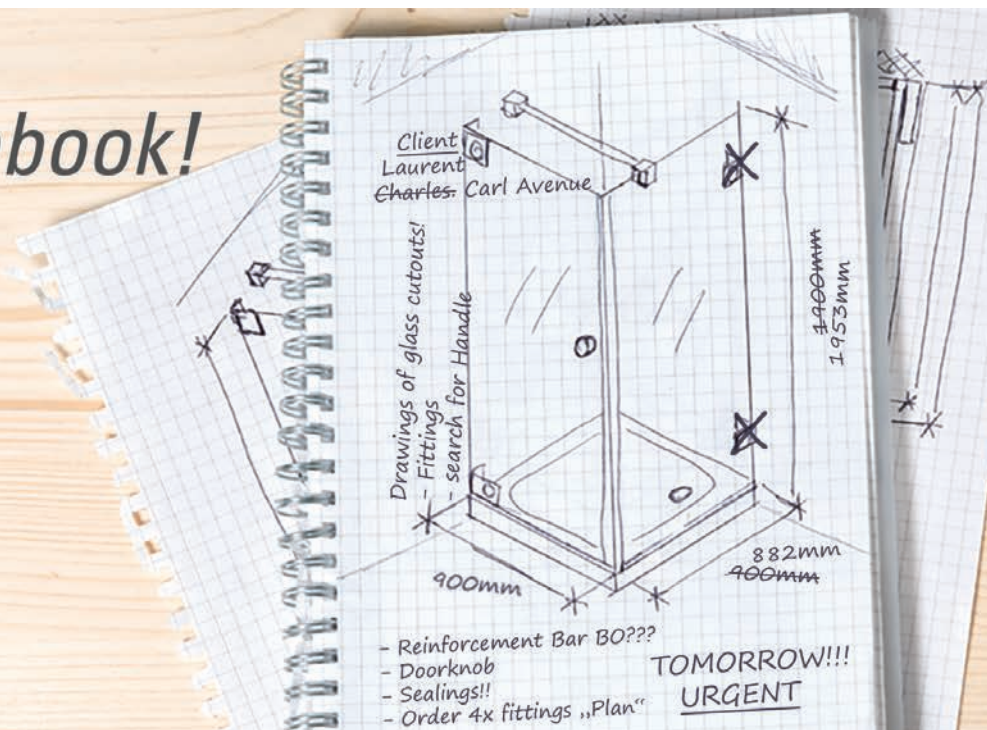



Next



Madrid



Lugo



Granada



Bilbao Select



Aqua

SHOWER DOOR HINGES

Hinges for one side opening Shower Doors	9
Swinging Shower Door Hinges	36
Sliding Door Systems For Showers	100
Bohle Vigo Walk-In Shower	114



REINFORCEMENT BARS

Bohle square	117
Bohle round	126



SHOWER DOOR HANDLES AND KNOBS

Shower door handles and knobs	139
-------------------------------	-----



SHOWER DOOR SEALING STRIPS

Shower Door Sealing Strips	153
Accessories	165

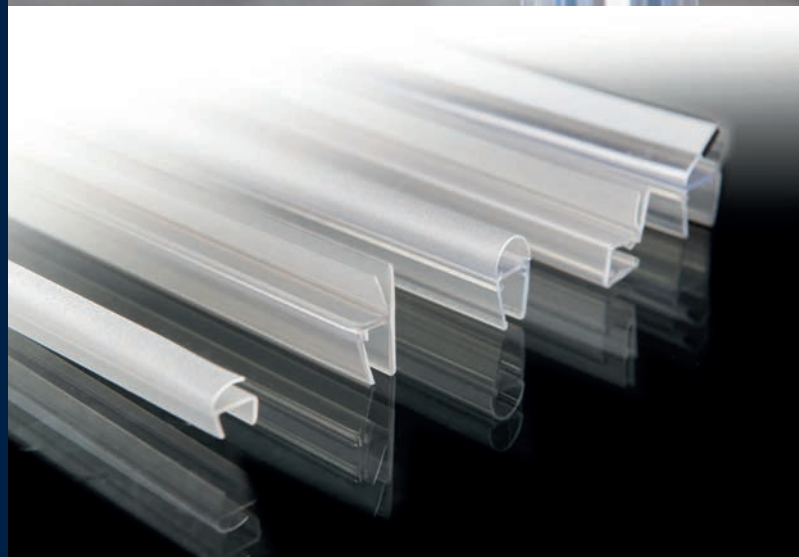

PROFILES

Profiles 169

CLEANING

Cleaner 171

Paper Towels 175

SURFACE PROTECTION

BriteGuard® 177

Accessories 180

INFORMATION

Index 185

Information 189



Hinges for one side opening Shower Doors

	Madrid	Bella	Lugo	Wellness®	Wellness® Premium
					
Page	10	14	18	23	31
Flush on the inner side			✓		
Rise and fall mechanism			✓		
Adjustable zero position					✓
Drill holes in glass	✓	✓	✓	✓	✓
Glass cut-out					
Glass thickness tempered glass (mm)	8 / 10	6 / 8	6 / 8	8	8
Max. door weight (kg)	40	40	36	40	40
Max. door height (mm)	2000	2250	2000	2250	2250
Max. door width (mm)	1000	1000	900	1000	1000
Inspection according to DIN 14428	✓	✓	✓	✓	✓

Bohle Madrid Shower Door Hinges

The Madrid shower door fittings are the elegant solution for shower doors. The hinges are designed for one side opening doors and enable the sealing strips to be directly guided through the hinge. No unsightly screw fittings are visible on the classic square design. In order to avoid the incorrect operation of the door (opening against the opening direction), sealing strips and, if necessary, a stop should be used. The door is kept closed by magnetic seals.



Shower Door Hinge Madrid glass/wall 90°, opens outwards



FINISH	ART. NO.
shiny chrome-plated	BO 5215430
max. door weight per pair	40 kg
max. door height	2000 mm
max. door width	1000 mm
material	brass

i Glass thickness 8, 10 mm · Elongated hole for wall mounting · No glass cut-outs - only drilled holes are required

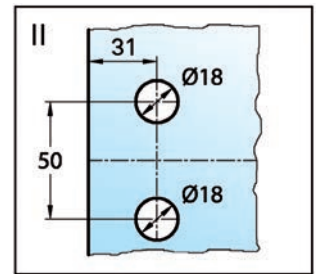
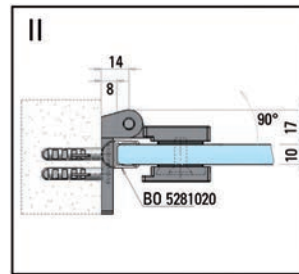
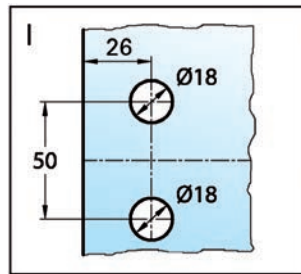
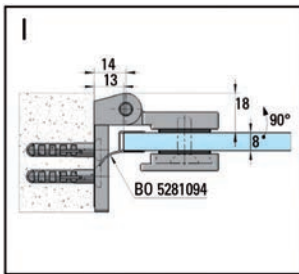
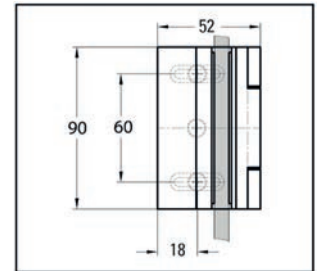
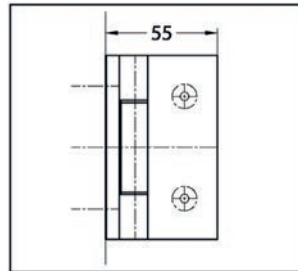

Shower Door Hinge Madrid glass/wall 90° With chamfer, opens outwards



FINISH	ART. NO.
shiny chrome-plated	BO 5215430H
max. door weight per pair	40 kg
max. door height	2000 mm
max. door width	1000 mm
material	brass

i The Madrid shower door hinge is now also available with a chamfer. The concavely curved backplate design allows for the optimal fit of the sealing strip between glass and wall. This sophisticated feature ensures water leaks are kept to a minimum. Trimming the bellows is no longer necessary. · Glass thickness 8, 10 mm · With chamfer · Elongated hole for wall mounting · No glass cut-outs - only drilled holes are required

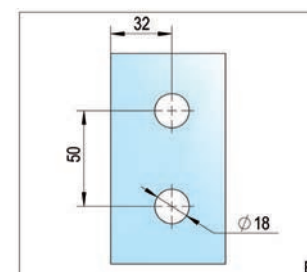
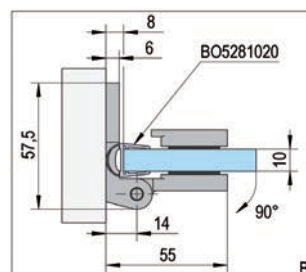
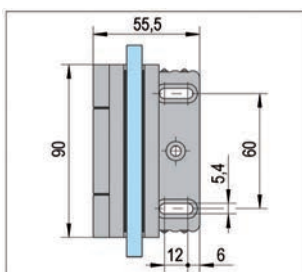
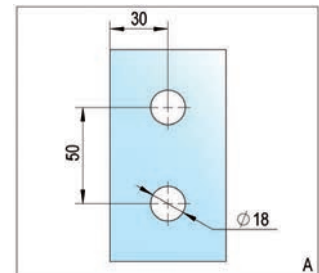
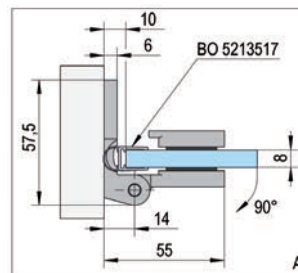

Shower Door Hinge Madrid glass/wall 90°, opens inwards



FINISH	ART. NO.
shiny chrome-plated	BO 5215431
max. door weight per pair	40 kg
max. door height	2000 mm
max. door width	1000 mm
material	brass

i Glass thickness 8, 10 mm · Elongated hole for wall mounting · No glass cut-outs - only drilled holes are required

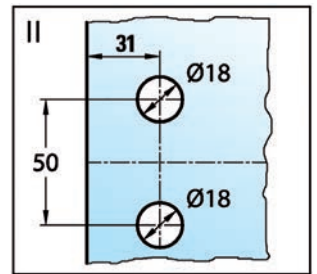
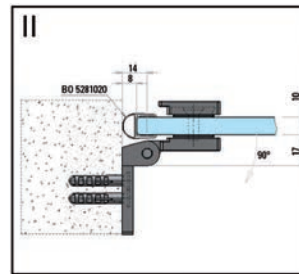
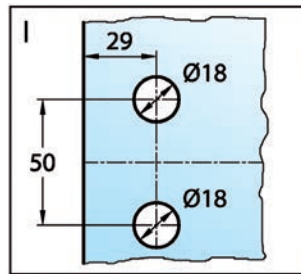
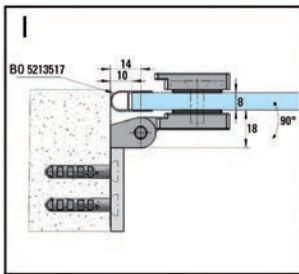
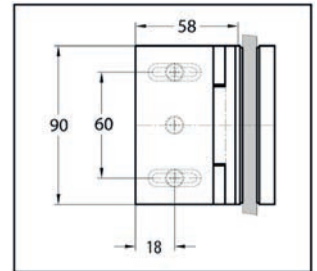
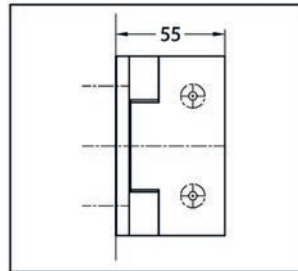

Shower Door Hinge Madrid glass/glass 180°



FINISH	ART. NO.
shiny chrome-plated	BO 5215432
max. door weight per pair	40 kg
max. door height	2000 mm
max. door width	1000 mm
material	brass

i Glass thickness 8, 10 mm · No glass cut-outs - only drilled holes are required

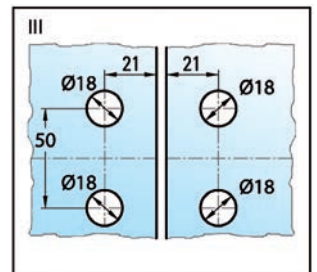
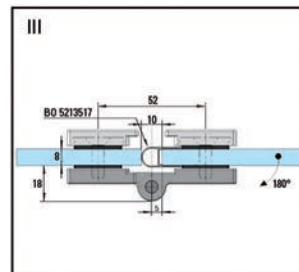
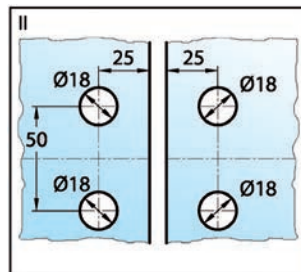
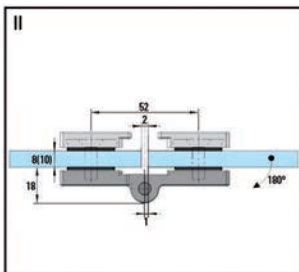
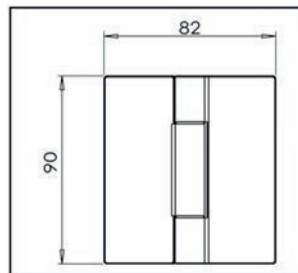

Corner Clamp Madrid glass/wall 90°



FINISH	ART. NO.
shiny chrome-plated	BO 5215433
max. door weight per pair	– kg
max. door height	– mm
max. door width	– mm
material	brass

1 Glass thickness 8, 10 mm · Elongated hole for wall mounting

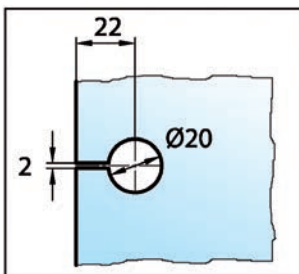
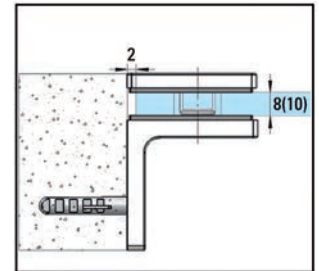
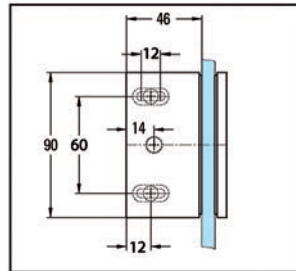

Corner Clamp Madrid glass/glass 90°



FINISH	ART. NO.
shiny chrome-plated	BO 5215434
max. door weight per pair	– kg
max. door height	– mm
max. door width	– mm
material	brass

1 Glass thickness 8, 10 mm

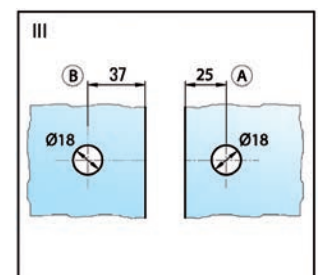
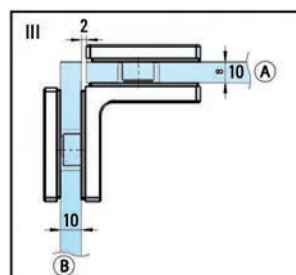
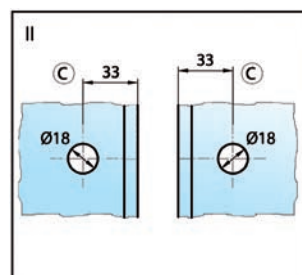
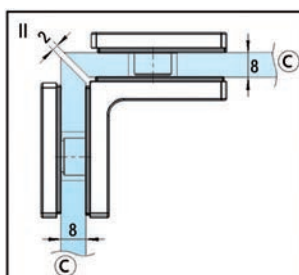
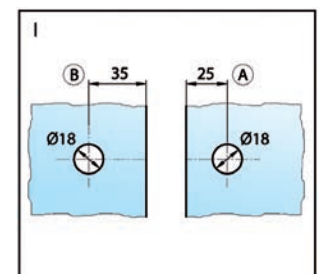
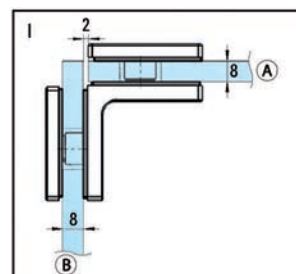

Bella Shower Door Hinges

Simply beautiful – the Bella shower door hinge captivates due to its unobtrusive elegance and perfection. Its discreet appearance ideally adapts to different bathroom styles. The sealing strips can be guided directly through the hinge (by-pass system).



Shower Door Hinge Bella glass/wall 90°, opens outwards



FINISH	ART. NO.
shiny chrome-plated	BK 8101231
max. door weight per pair	40 kg
max. door height	2250 mm
max. door width	1000 mm
material	brass

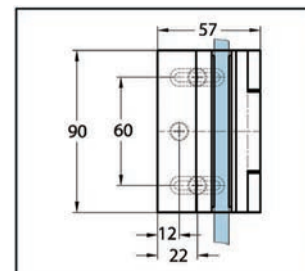
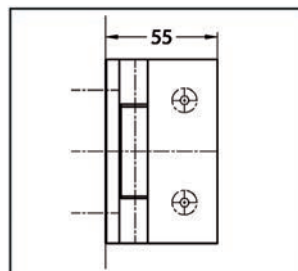

i Glass thickness 6, 8 mm · Elongated hole for wall mounting · No glass cut-outs - only drilled holes are required

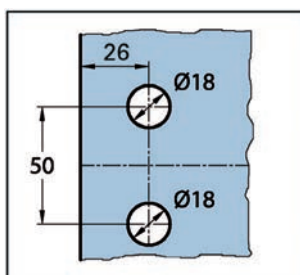
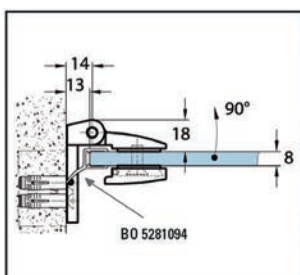

Shower Door Hinge Bella glass/wall 90° With chamfer, opens outwards



FINISH	ART. NO.
shiny chrome-plated	BK 8101431
max. door weight per pair	40 kg
max. door height	2250 mm
max. door width	1000 mm
material	brass

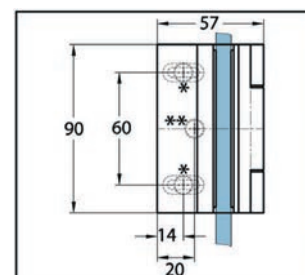
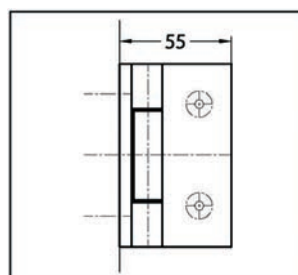

i The design of the groove enables the sealing strip to be simply guided through the hinge. Therefore, cutting the sealing strip or the bellow is no longer required. Glass thickness 6, 8 mm · Elongated hole for wall mounting · No glass cut-outs - only drilled holes are required

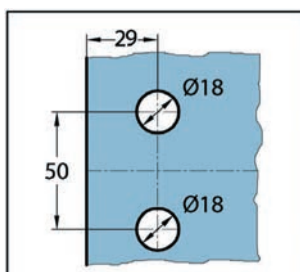
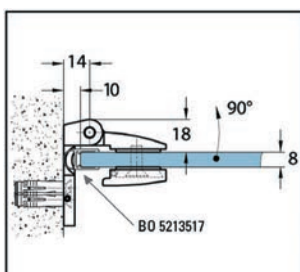

Shower Door Hinge Bella glass/wall 90°, opens inwards



FINISH	ART. NO.
shiny chrome-plated	BK 8101331
max. door weight per pair	40 kg
max. door height	2250 mm
max. door width	1000 mm
material	brass

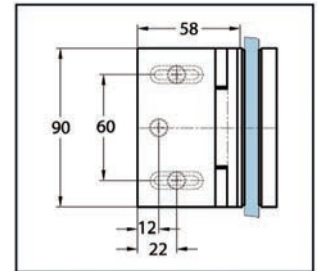
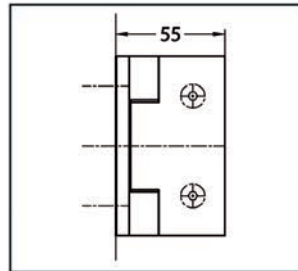

i Glass thickness 6, 8 mm · Elongated hole for wall mounting · No glass cut-outs - only drilled holes are required

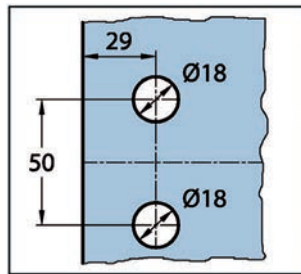
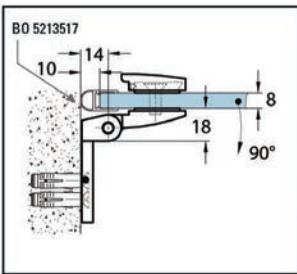

Shower Door Hinge Bella glass/glass 180°



FINISH	ART. NO.
shiny chrome-plated	BK 8103031
max. door weight per pair	40 kg
max. door height	2250 mm
max. door width	1000 mm
material	brass

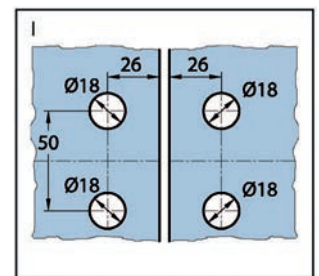
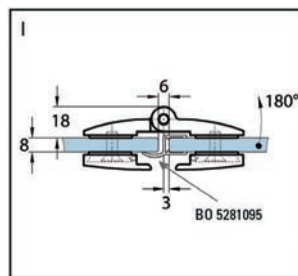

i Glass thickness 6, 8 mm · No glass cut-outs - only drilled holes are required

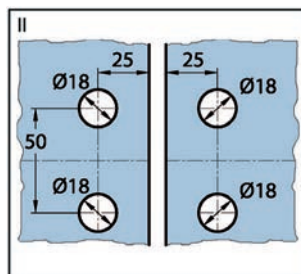
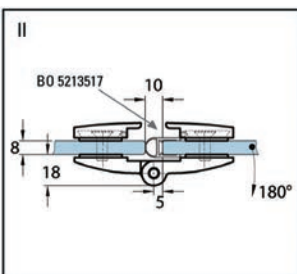

Corner Clamp Bella glass/wall 90°



FINISH	ART. NO.
shiny chrome-plated	BK 8108031
max. door weight per pair	– kg
max. door height	– mm
max. door width	– mm
material	brass

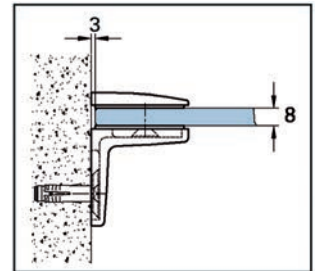
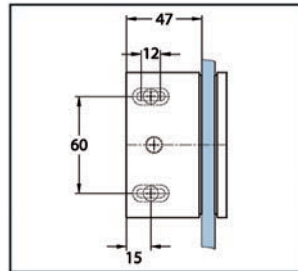

i Glass thickness 6, 8 mm · Elongated hole for wall mounting

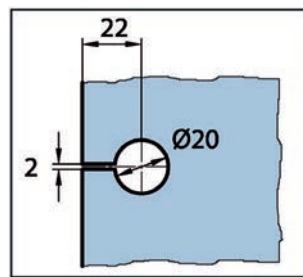
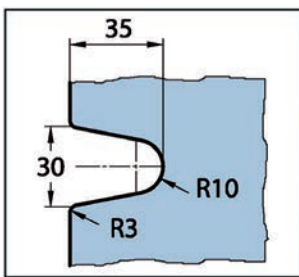

Corner Clamp Bella glass/glass 90°



FINISH	ART. NO.
shiny chrome-plated	BK 8108331
max. door weight per pair	– kg
max. door height	– mm
max. door width	– mm
material	brass

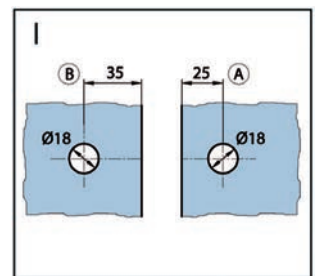
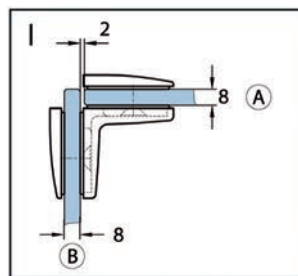

i Glass thickness 6, 8 mm

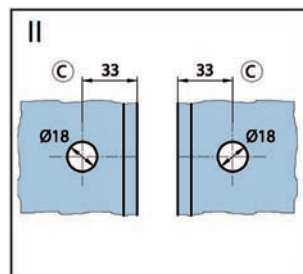
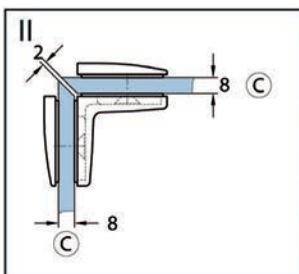

Lugo Shower Door Hinges

An all-rounder for the most diverse bathroom styles. Thanks to its modern and contemporary design, the high quality, all-brass range of fittings fits perfectly into any bathroom design. Its straight-lined design with slightly rounded-off edges makes Lugo an elegant classic. Technical fixings and screws are concealed behind a cover, achieving a clear and unobtrusive design. In addition, the flush installation enables easy cleaning. The rise and fall function offers enhanced comfort - the door fittings close automatically, smoothly and silently. Lugo is therefore the ideal choice for use in barrier-free shower applications. In order to avoid the incorrect operation of the door (opening against the opening direction), sealing strips and, if necessary, a stop should be used.



Shower Door Hinge Lugo glass/wall 90°, opens outwards DIN left



FINISH	ART. NO.
shiny chrome-plated	BO 5240000
max. door weight per pair	36 kg
max. door height	2000 mm
max. door width	900 mm
material	brass

i Glass thickness 6, 8 mm · Lifting height 5 mm · The door is kept closed by magnetic seals.

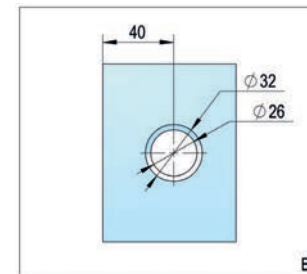
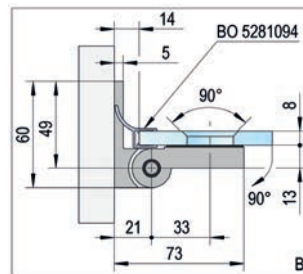
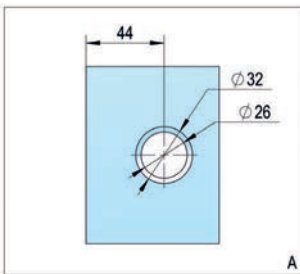
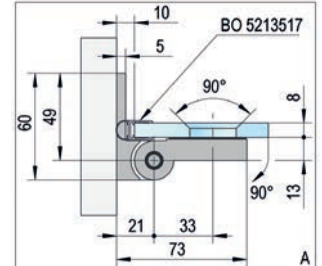
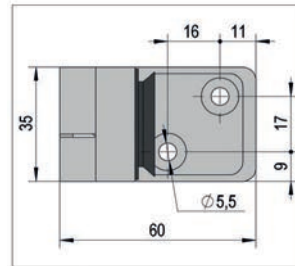

Shower Door Hinge Lugo glass/wall 90°, opens outwards DIN right



FINISH	ART. NO.
shiny chrome-plated	BO 5240001
max. door weight per pair	36 kg
max. door height	2000 mm
max. door width	900 mm
material	brass

i Glass thickness 6, 8 mm · Lifting height 5 mm · The door is kept closed by magnetic seals.

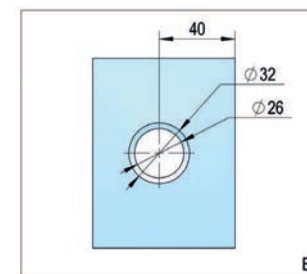
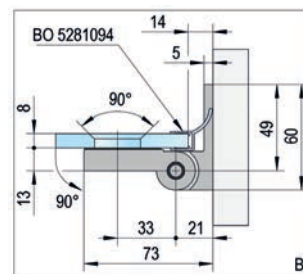
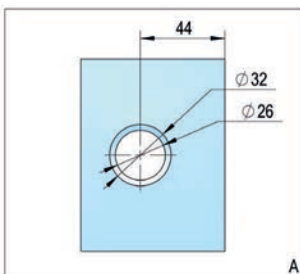
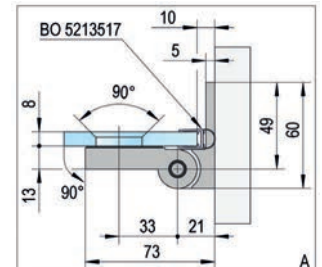
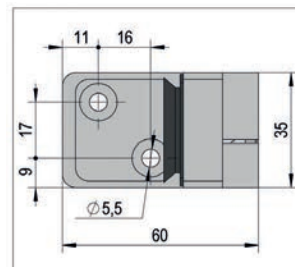

Shower Door Hinge Lugo glass/glass 180°, opens outwards DIN left



FINISH	ART. NO.
shiny chrome-plated	BO 5240002
max. door weight per pair	36 kg
max. door height	2000 mm
max. door width	900 mm
material	brass

i Glass thickness 6, 8 mm · Lifting height 5 mm · The door is kept closed by magnetic seals.

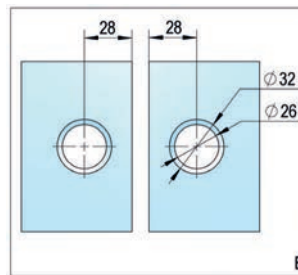
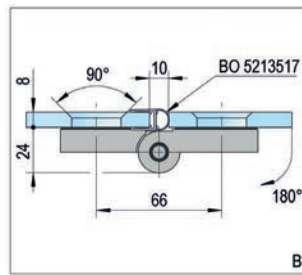
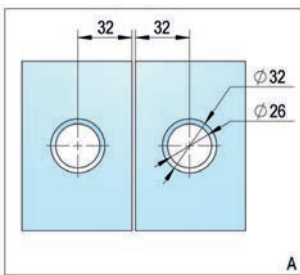
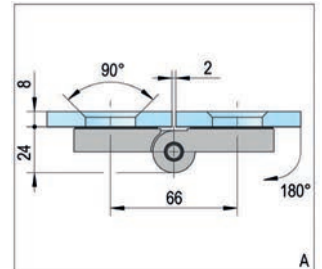
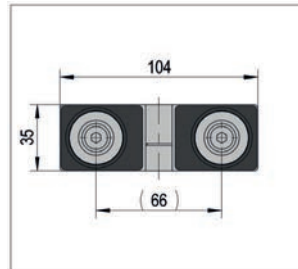

Shower Door Hinge Lugo glass/glass 180°, opens outwards DIN right



FINISH	ART. NO.
shiny chrome-plated	BO 5240003
max. door weight per pair	36 kg
max. door height	2000 mm
max. door width	900 mm
material	brass

i Glass thickness 6, 8 mm · Lifting height 5 mm · The door is kept closed by magnetic seals.

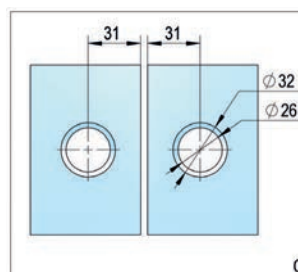
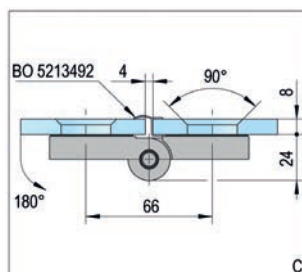
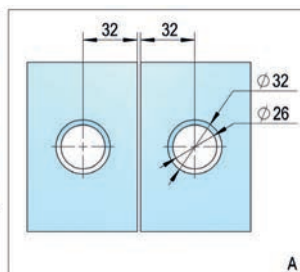
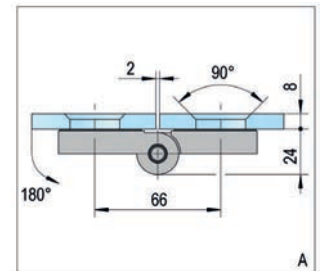
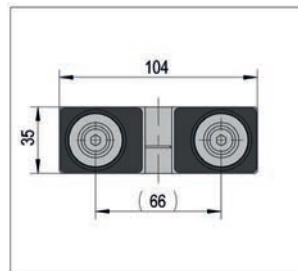

Shower Door Hinge Lugo glass/glass 135°, opens outwards DIN left



FINISH	ART. NO.
shiny chrome-plated	BO 5240004
max. door weight per pair	36 kg
max. door height	2000 mm
max. door width	900 mm
material	brass

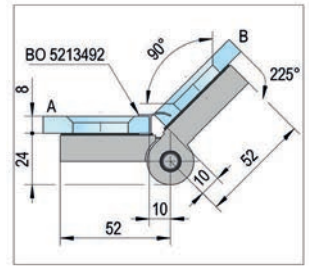
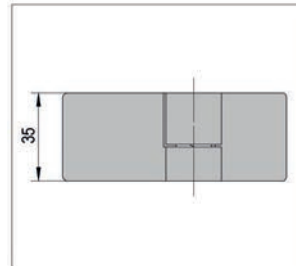

i Glass thickness 6, 8 mm · Lifting height 5 mm · The door is kept closed by magnetic seals.

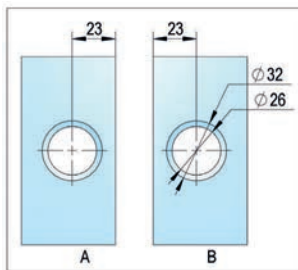

Shower Door Hinge Lugo glass/glass 135°, opens outwards DIN right



FINISH	ART. NO.
shiny chrome-plated	BO 5240005
max. door weight per pair	36 kg
max. door height	2000 mm
max. door width	900 mm
material	brass

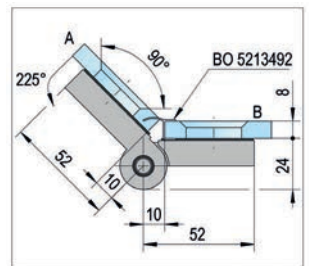
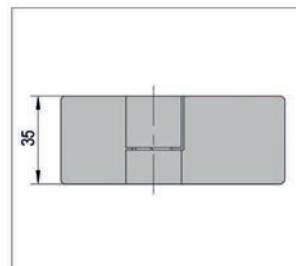

i Glass thickness 6, 8 mm · Lifting height 5 mm · The door is kept closed by magnetic seals.

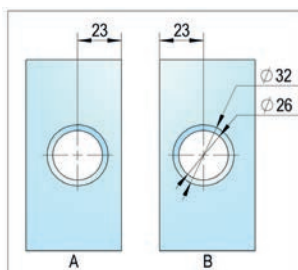

Corner Clamp Lugo glass/wall 90°



i Glass thickness 6, 8 mm

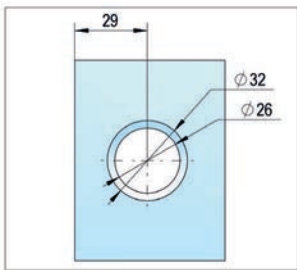

FINISH	ART. NO.
shiny chrome-plated	BO 5240006
max. door weight per pair	– kg
max. door height	– mm
max. door width	– mm
material	brass

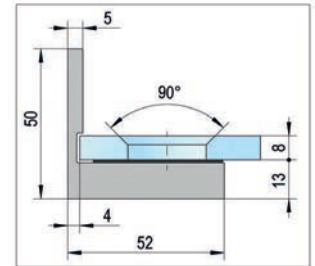
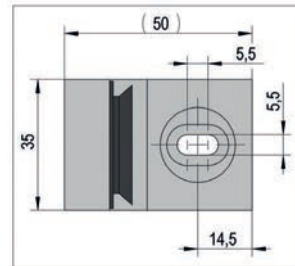

Corner Clamp Lugo glass/glass 90°



i Glass thickness 6, 8 mm

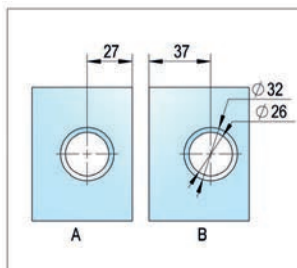

FINISH	ART. NO.
shiny chrome-plated	BO 5240007
max. door weight per pair	– kg
max. door height	– mm
max. door width	– mm
material	brass

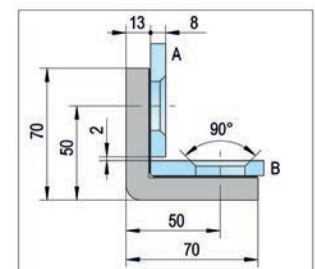
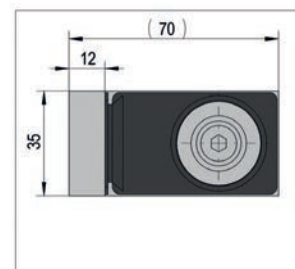

Wellness® Shower Door Hinges

Wellness® fittings offer superior comfort in a flexible shower system. Their use is as versatile as can be: in standard designs, frameless constructions or bi-folding door systems. The door hinges swing freely. The latching function is achieved by magnetic sealing profiles. Sealing profiles can also be guided through the hinge itself (by-pass system). Maximum door weight per pair of hinges: 40 kg, maximum door width: 1000 mm. In order to avoid the incorrect operation of the door (opening against the opening direction), sealing strips and, if necessary, a stop should be used. The door is kept closed by magnetic seals.



Shower Door Hinge Wellness® glass/wall 90°, opens outwards, one side wall mounted



FINISH	ART. NO.
shiny chrome-plated	BK 0641031
max. door weight per pair	40 kg
max. door height	2250 mm
max. door width	1000 mm
material	brass

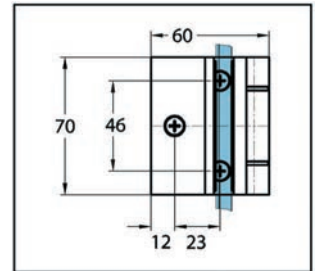
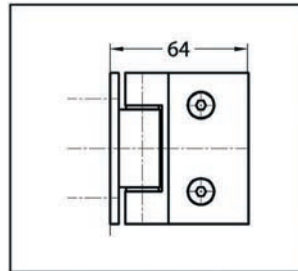

i Glass thickness 8 mm

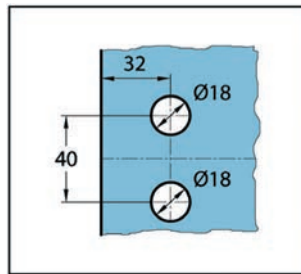
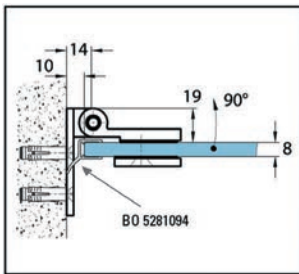

Shower Door Hinge Wellness® glass/wall 90°, opens inwards, one side wall mounted



FINISH	ART. NO.
shiny chrome-plated	BK 0641131
max. door weight per pair	40 kg
max. door height	2250 mm
max. door width	1000 mm
material	brass

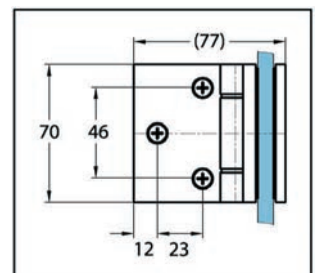
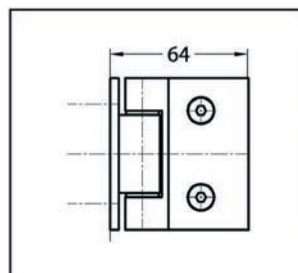

i Glass thickness 8 mm

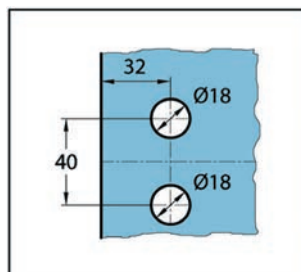
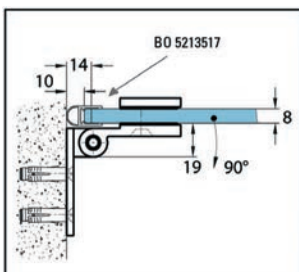

Shower Door Hinge Wellness® glass/wall 90°, opens outwards, elongated mounting plate

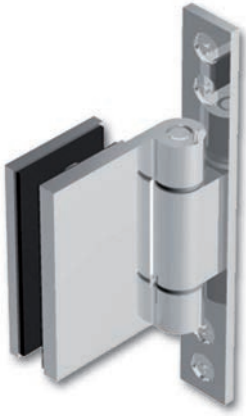

FINISH	ART. NO.
shiny chrome-plated	BK 0641531
max. door weight per pair	40 kg
max. door height	2250 mm
max. door width	1000 mm
material	brass

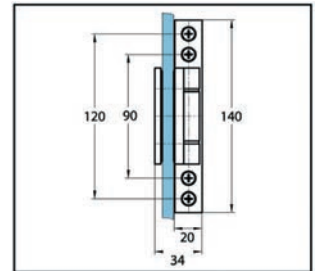
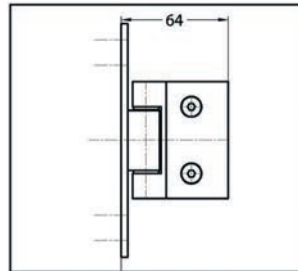

i Glass thickness 8 mm

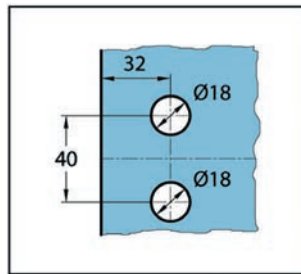
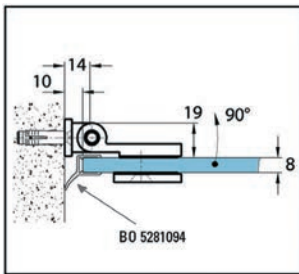

Shower Door Hinge Wellness® glass/wall 90°, opens inwards, elongated mounting plate



FINISH	ART. NO.
shiny chrome-plated	BK 0641631
max. door weight per pair	40 kg
max. door height	2250 mm
max. door width	1000 mm
material	brass

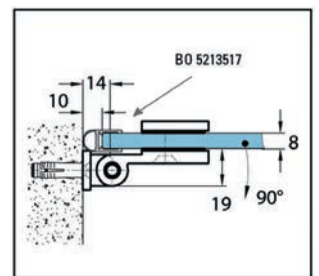
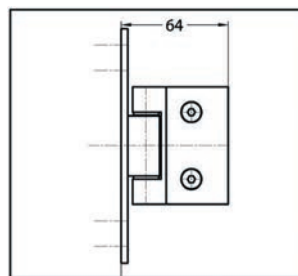

i Glass thickness 8 mm

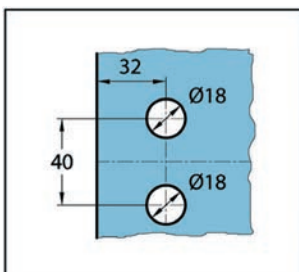

Shower Door Hinge Wellness® glass/glass 180°, opens outwards



i Glass thickness 8 mm

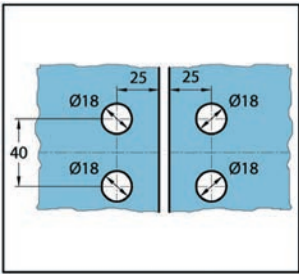

FINISH	ART. NO.
shiny chrome-plated	BK 0643031
max. door weight per pair	40 kg
max. door height	2250 mm
max. door width	1000 mm
material	brass

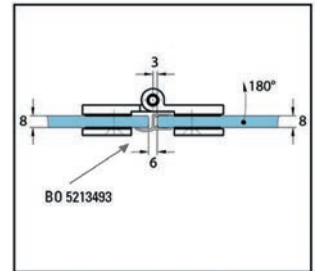
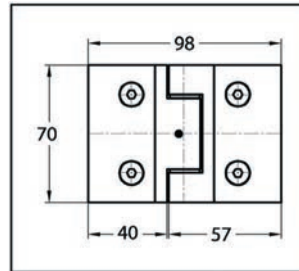

Shower Door Hinge Wellness® glass/glass 180°, opens inwards



i Glass thickness 8 mm

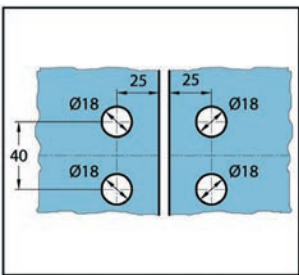

FINISH	ART. NO.
shiny chrome-plated	BK 0643131
max. door weight per pair	40 kg
max. door height	2250 mm
max. door width	1000 mm
material	brass

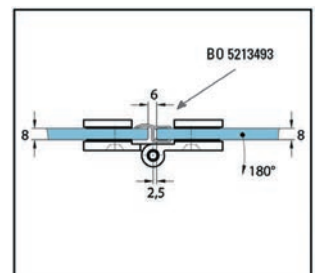
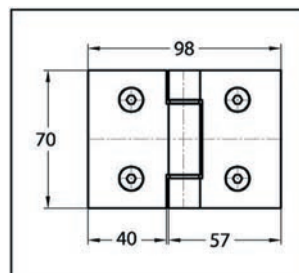

Shower Door Hinge Wellness® glass/glass 135° / 180°, opens outwards



FINISH	ART. NO.
shiny chrome-plated	BK 0647031
max. door weight per pair	40 kg
max. door height	2250 mm
max. door width	1000 mm
material	brass

i Glass thickness 8 mm

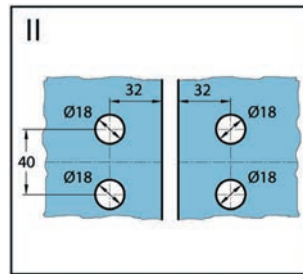
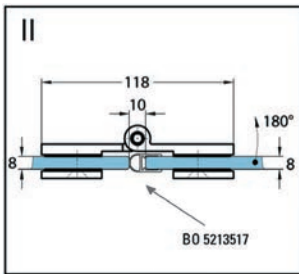
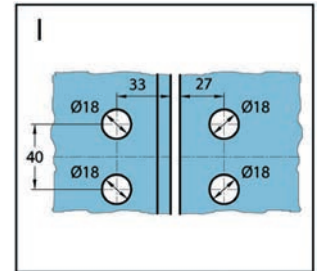
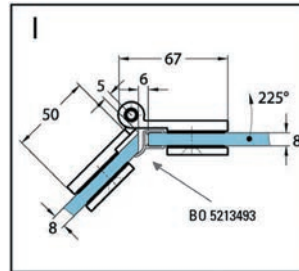

Corner Clamp Wellness® glass/wall 90°



FINISH	ART. NO.
shiny chrome-plated	BK 0648031
max. door weight per pair	– kg
max. door height	– mm
max. door width	– mm
material	brass

i Glass thickness 8 mm

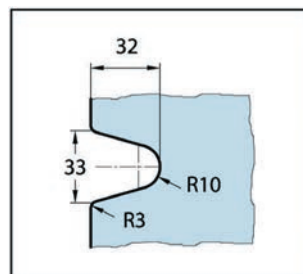
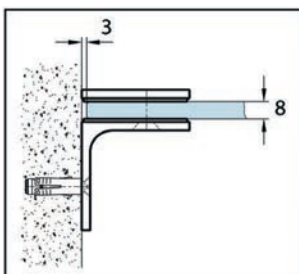
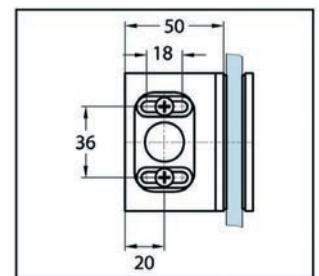
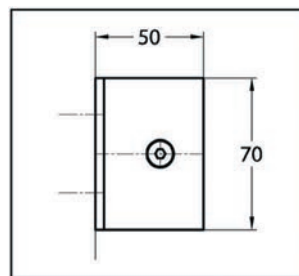

Corner Clamp Wellness® glass/wall 90°



i Glass thickness 8 mm

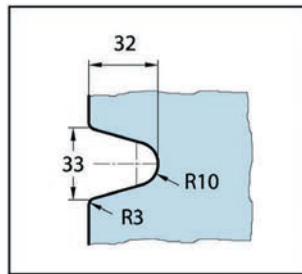
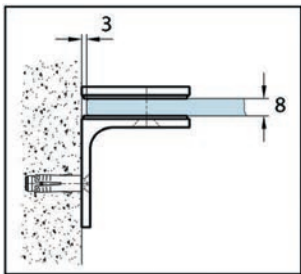

FINISH	ART. NO.
shiny chrome-plated	BK 0648131
max. door weight per pair	– kg
max. door height	– mm
max. door width	– mm
material	brass

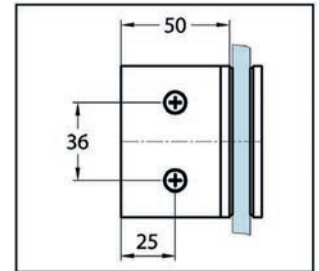
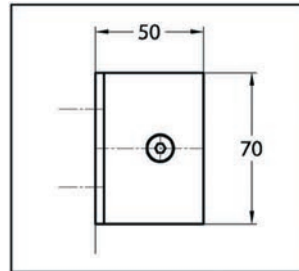

Corner Clamp Wellness® glass/glass 90°



i Glass thickness 8 mm

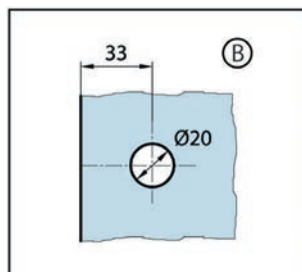
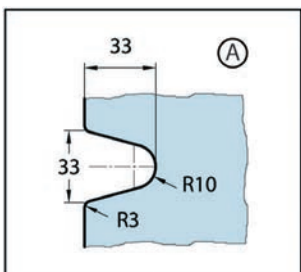

FINISH	ART. NO.
shiny chrome-plated	BK 0648331
max. door weight per pair	– kg
max. door height	– mm
max. door width	– mm
material	brass

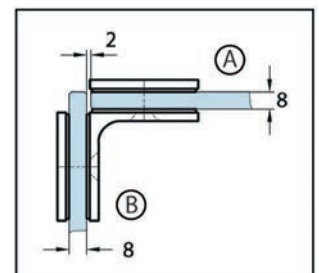
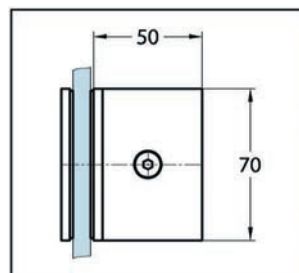

Corner Clamp Wellness® glass/wall 135°



i Glass thickness 8 mm

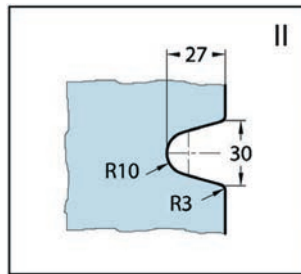
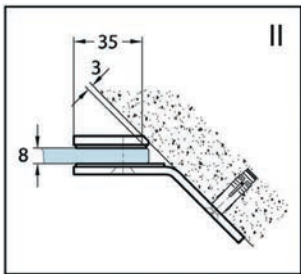

FINISH	ART. NO.
shiny chrome-plated	BK 0648531
max. door weight per pair	- kg
max. door height	- mm
max. door width	- mm
material	brass

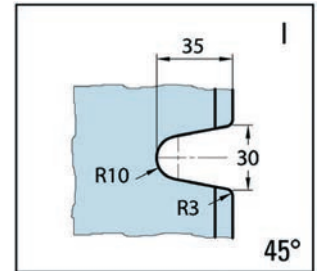
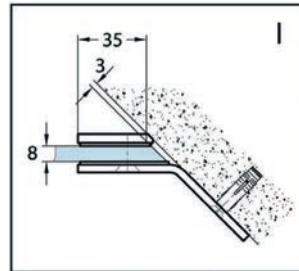

Corner Clamp Wellness® glass/glass 135°



i Glass thickness 8 mm

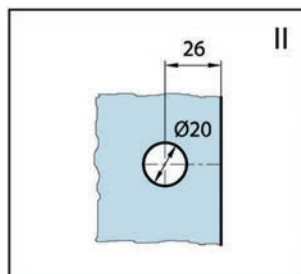
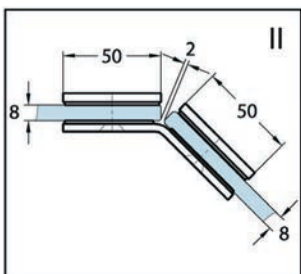

FINISH	ART. NO.
shiny chrome-plated	BK 0648731
max. door weight per pair	- kg
max. door height	- mm
max. door width	- mm
material	brass

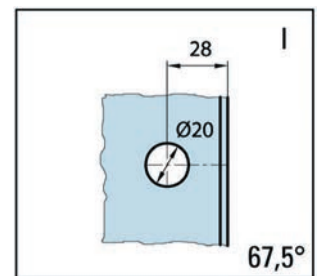
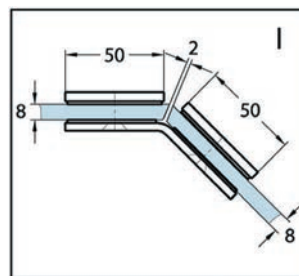

Side Connector Wellness® glass/wall 180°



i Glass thickness 8 mm

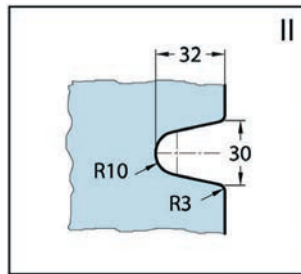
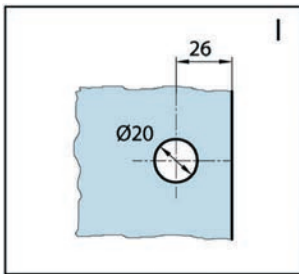

FINISH	ART. NO.
shiny chrome-plated	BK 0647131
max. door weight per pair	– kg
max. door height	– mm
max. door width	– mm
material	brass

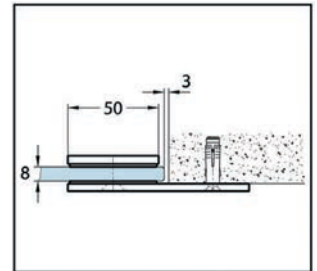
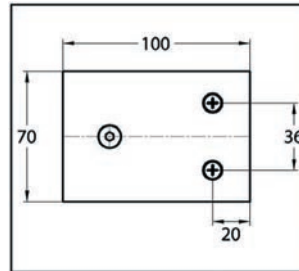

Side Connector Wellness® glass/glass 180°



i Glass thickness 8 mm

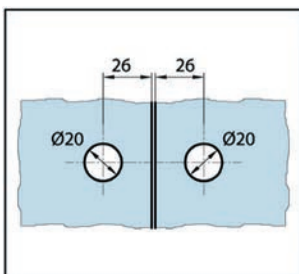

FINISH	ART. NO.
shiny chrome-plated	BK 0647331
max. door weight per pair	– kg
max. door height	– mm
max. door width	– mm
material	brass

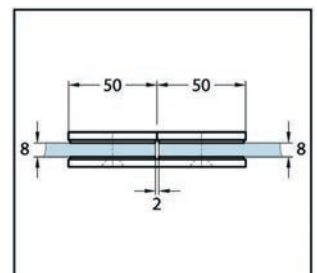
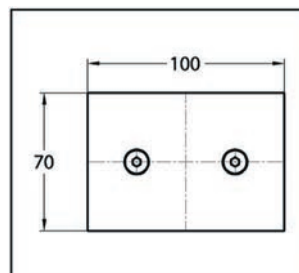

Wellness® Premium Shower Door Hinges

The Wellness® hinge offers comfort in a flexible shower system. It is very versatile and can be installed in a standard design, a frameless concept or in a bi-folding door system. The hinges swing freely. With this hinge, the door is kept closed by magnetic seals. In this case, the sealing strips can be guided through the hinge (by-pass system).

Shower Door Hinge Wellness® Premium glass/wall 90°, opens outwards DIN right



FINISH	ART. NO.
shiny chrome-plated	BK 1641031
max. door weight per pair	40 kg
max. door height	2250 mm
max. door width	1000 mm
material	brass

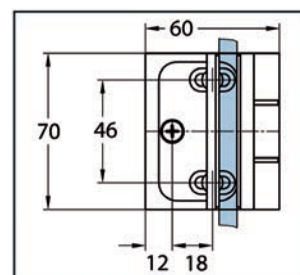
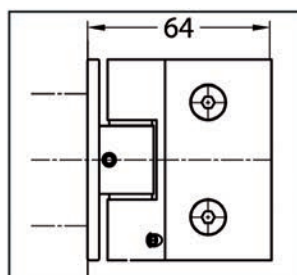

i Glass thickness 8 mm

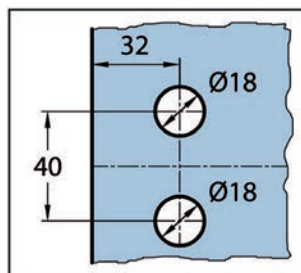
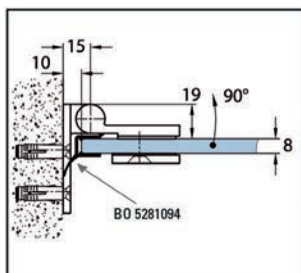

Shower Door Hinge Wellness® Premium glass/wall 90°, opens outwards DIN left



FINISH	ART. NO.
shiny chrome-plated	BK 1641231
max. door weight per pair	40 kg
max. door height	2250 mm
max. door width	1000 mm
material	brass

i Glass thickness 8 mm

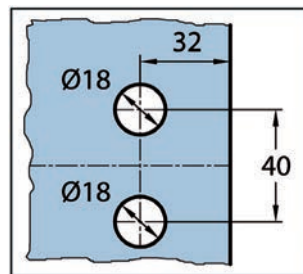
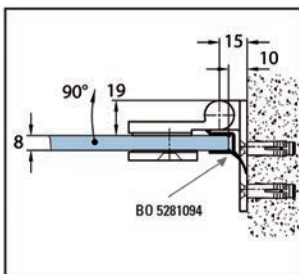
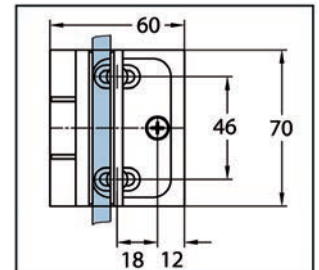
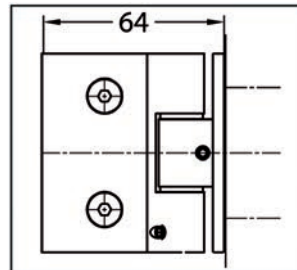

Shower Door Hinge Wellness® Premium glass/wall 90°, opens inwards DIN right



FINISH	ART. NO.
shiny chrome-plated	BK 1641331
max. door weight per pair	40 kg
max. door height	2250 mm
max. door width	1000 mm
material	brass

i Glass thickness 8 mm

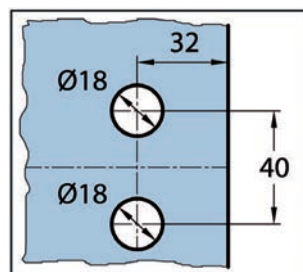
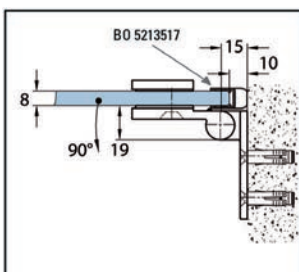
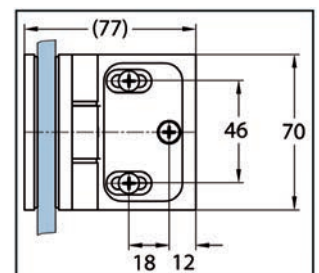
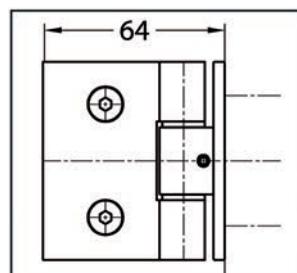

Shower Door Hinge Wellness® Premium glass/wall 90°, opens inwards DIN left



FINISH	ART. NO.
shiny chrome-plated	BK 1641131
max. door weight per pair	40 kg
max. door height	2250 mm
max. door width	1000 mm
material	brass

i Glass thickness 8 mm

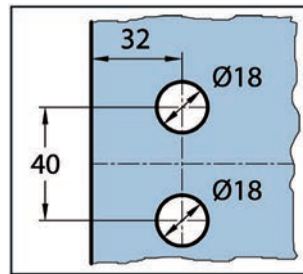
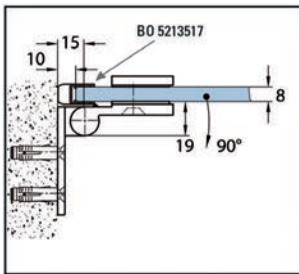
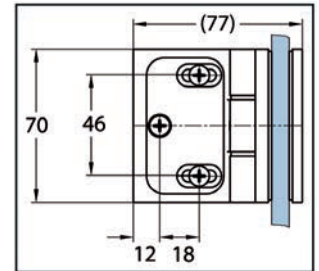
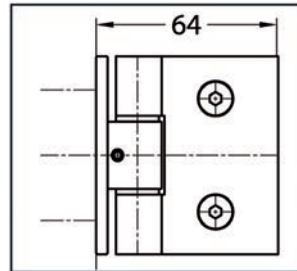

Shower Door Hinge Wellness® Premium glass/glass 180°, opens outwards DIN right



FINISH	ART. NO.
shiny chrome-plated	BK 1643031
max. door weight per pair	40 kg
max. door height	2250 mm
max. door width	1000 mm
material	brass

i Glass thickness 8 mm

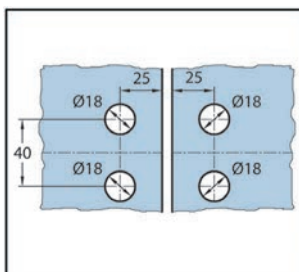
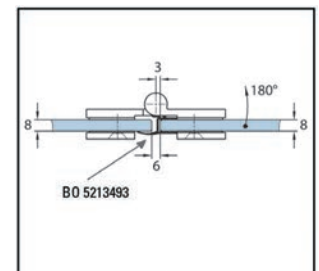
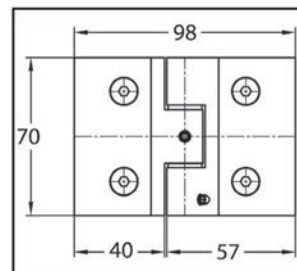

Shower Door Hinge Wellness® Premium glass/glass 180°, opens outwards DIN left



FINISH	ART. NO.
shiny chrome-plated	BK 1643231
max. door weight per pair	40 kg
max. door height	2250 mm
max. door width	1000 mm
material	brass

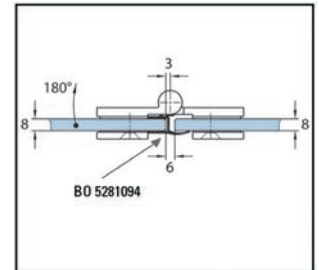
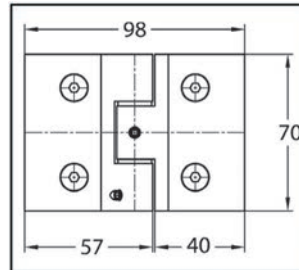

i Glass thickness 8 mm

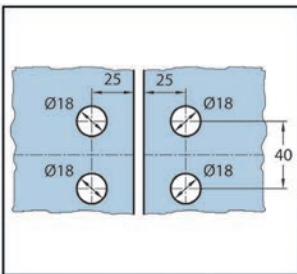

Shower Door Hinge Wellness® Premium glass/glass 180°, opens inwards DIN right



FINISH	ART. NO.
shiny chrome-plated	BK 1643331
max. door weight per pair	40 kg
max. door height	2250 mm
max. door width	1000 mm
material	brass

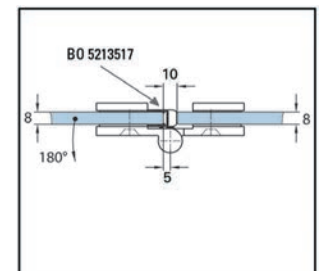
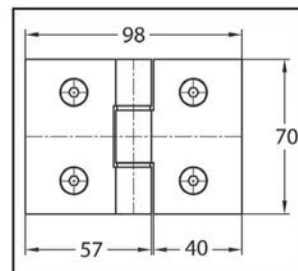

i Glass thickness 8 mm

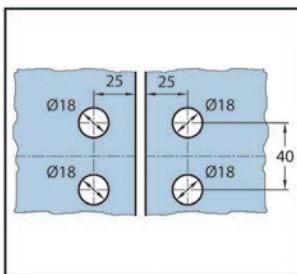

Shower Door Hinge Wellness® Premium glass/glass 180°, opens inwards DIN left



FINISH	ART. NO.
shiny chrome-plated	BK 1643131
max. door weight per pair	40 kg
max. door height	2250 mm
max. door width	1000 mm
material	brass

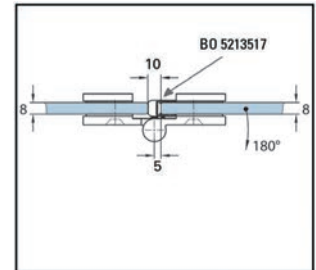
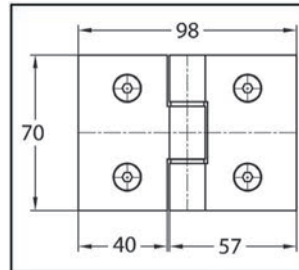

i Glass thickness 8 mm

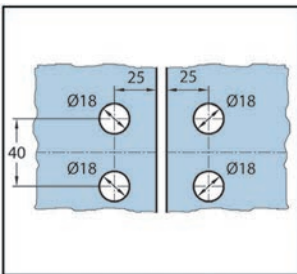

Shower Door Hinge Wellness® Premium glass/glass 135°, opens outwards DIN right





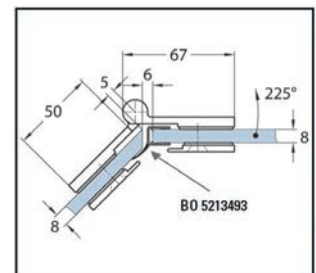
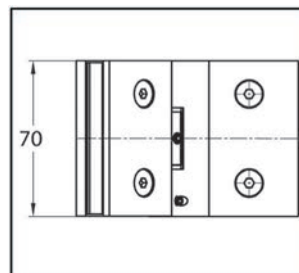

FINISH	ART. NO.
shiny chrome-plated	BK 1647031
max. door weight per pair	40 kg
max. door height	2250 mm
max. door width	1000 mm
material	brass

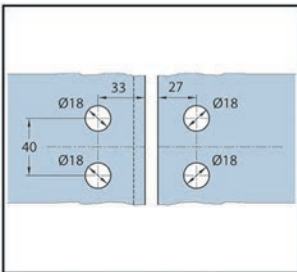

i Glass thickness 8 mm



Swinging Shower Door Hinges

	Bilbao Premium	Bilbao Select	Bilbao	Barcelona Select	Barcelona
					
Page	38	44	50	54	60
Flush on the inner side					
Rise and fall mechanism					
Adjustable zero position	✓	✓		✓	
Drill holes in glass					
Glass cut-out	✓	✓	✓	✓	✓
Glass thickness tempered glass (mm)	8 / 10 / 12	8 / 10 / 12	8 / 10 / 12	8 / 10 / 12	8 / 10 / 12
Max. door weight (kg)	50 / 40	40	36	40	36
Max. door height (mm)	2000	2000	2000	2000	2000
Max. door width (mm)	1000	1000	900	1000	900
Inspection according to DIN 14428	✓				

Milano Original	Europe	Granada	Next	Plan artist	Aqua	Art	Easy
							
64	69	73	78	82	89	92	96
			✓	✓			
			✓	✓	✓		
✓	✓	✓	✓		✓		✓
			✓	✓			
✓	✓	✓	✓	✓		✓	✓
8 / 10	8 / 10	8 / 10	8 / 10	8	6 / 8	6 / 8 / 10	8
50	40	35	40	38	35	35	38
2250 (8)	2000	2000	2250	2100	2187	2000	2250
1000 (8) 850 (10)	1000	900	900	900	800	750	900
✓	✓		✓	✓			✓

Bohle Bilbao Premium Shower Door Hinges

The Bilbao Premium shower door hinge series combines modern, square design with useful technical details. Thanks to its versatility and functionality as well as its outstanding price/performance ratio, the Bilbao Premium range is popular with builders, planners and architects. Bilbao Premium is equipped with a self-closing function starting from an opening angle of approx. $\pm 15^\circ$. Outside this range, the hinge can stop in any position. In addition, the Bilbao Premium benefits from an adjustable zero position, making the alignment of the door much easier for installers.



Shower Door Hinge Bilbao Premium HD glass/wall 90°, one side wall mounted



FINISH	ART. NO.
shiny chrome-plated	BO 5211563
stainless steel look	BO 5211564
max. door weight per pair	50 kg
max. door height	2000 mm
max. door width	1000 mm
material	brass

i Glass thickness 8, 10, 12 mm · Self-closing from 15° · Continuously adjustable zero position · Supplied without mounting hardware

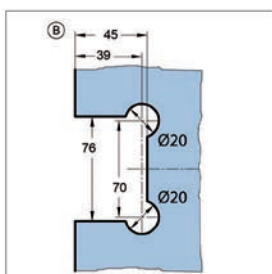
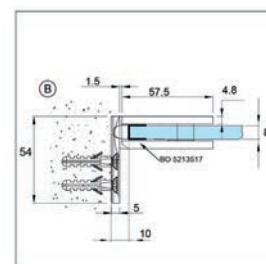
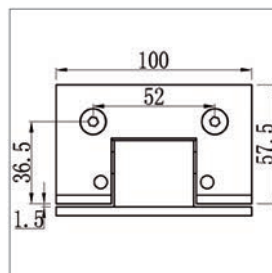

Shower Door Hinge Bilbao Premium glass / wall 90°, one side wall mounted



FINISH	ART. NO.
shiny chrome-plated	BO 5211553
stainless steel look	BO 5211554
max. door weight per pair	40 kg
max. door height	2000 mm
max. door width	1000 mm
material	brass

i Glass thickness 8, 10, 12 mm · Self-closing from 15° · Continuously adjustable zero position · Supplied without mounting hardware

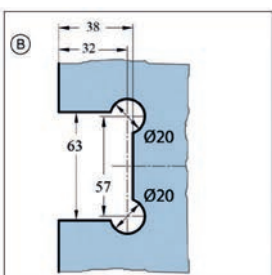
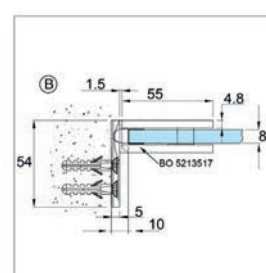
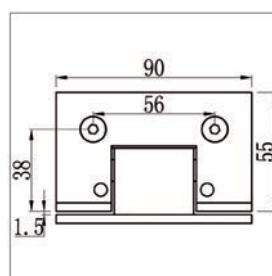

Shower Door Hinge Bilbao Premium HD glass / wall 90°, both sides wall mounted



i Glass thickness 8, 10, 12 mm · Self-closing from 15° · Continuously adjustable zero position · Supplied without mounting hardware

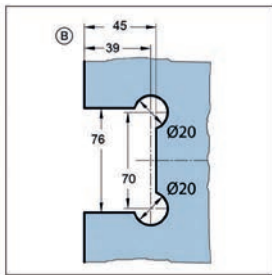

FINISH	ART. NO.
shiny chrome-plated	BO 5211561
stainless steel look	BO 5211562
max. door weight per pair	50 kg
max. door height	2000 mm
max. door width	1000 mm
material	brass

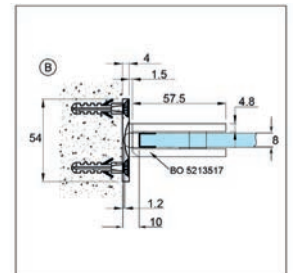
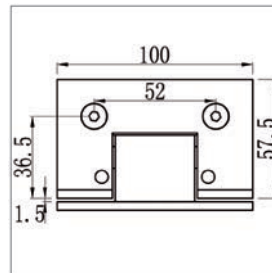

Shower Door Hinge Bilbao Premium glass / wall 90°, both sides wall mounted



i Glass thickness 8, 10, 12 mm · Self-closing from 15° · Continuously adjustable zero position · Supplied without mounting hardware

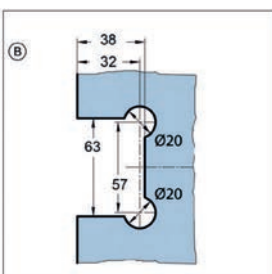

FINISH	ART. NO.
shiny chrome-plated	BO 5211551
stainless steel look	BO 5211552
max. door weight per pair	40 kg
max. door height	2000 mm
max. door width	1000 mm
material	brass

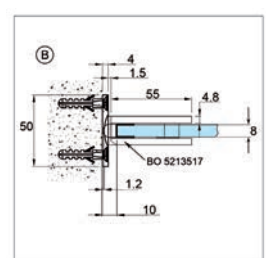
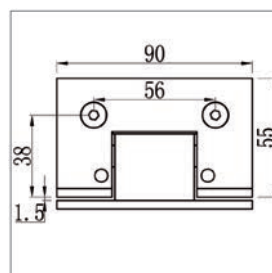

Shower Door Hinge Bilbao Premium glass/glass 90°



FINISH	ART. NO.
shiny chrome-plated	BO 5211557
stainless steel look	BO 5211558
max. door weight per pair	40 kg
max. door height	2000 mm
max. door width	1000 mm
material	brass

i Glass thickness 8, 10, 12 mm · Self-closing from 15° · Continuously adjustable zero position

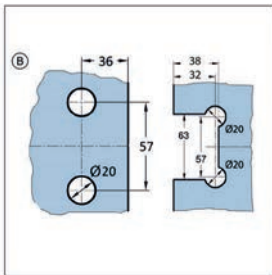
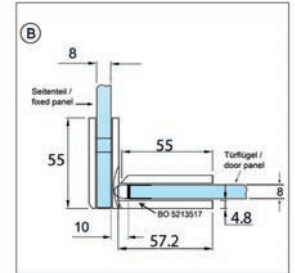
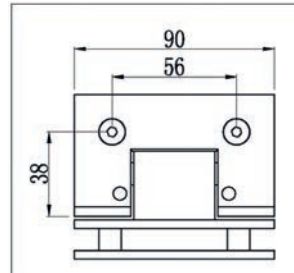

Shower Door Hinge Bilbao Premium HD glass/glass 180°



FINISH	ART. NO.
shiny chrome-plated	BO 5211565
stainless steel look	BO 5211566
max. door weight per pair	50 kg
max. door height	2000 mm
max. door width	1000 mm
material	brass

i Glass thickness 8, 10, 12 mm · Self-closing from 15° · Continuously adjustable zero position

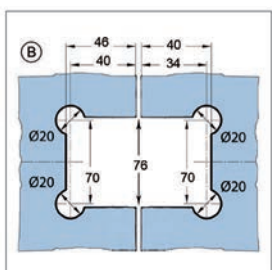
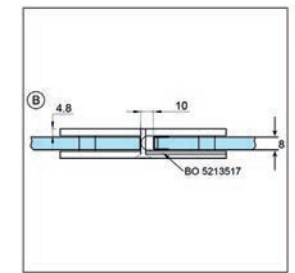
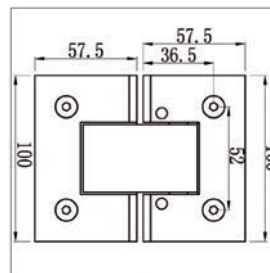

Shower Door Hinge Bilbao Premium glass/glass 180°



FINISH	ART. NO.
shiny chrome-plated	BO 5211555
stainless steel look	BO 5211556
max. door weight per pair	40 kg
max. door height	2000 mm
max. door width	1000 mm
material	brass

i Glass thickness 8, 10, 12 mm · Self-closing from 15° · Continuously adjustable zero position

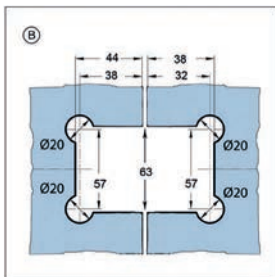
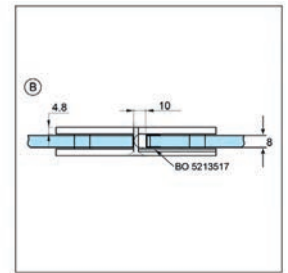
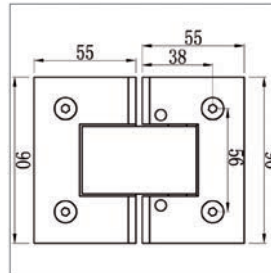

Corner Clamp Bilbao Premium HD glass/wall 90°



FINISH	ART. NO.
shiny chrome-plated	BO 5211567N
stainless steel look	BO 5211568N
max. door weight per pair	– kg
max. door height	– mm
max. door width	– mm
material	brass

i Glass thickness 8, 10, 12 mm · Supplied without mounting hardware

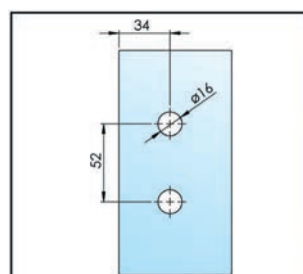
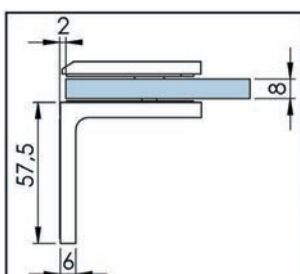
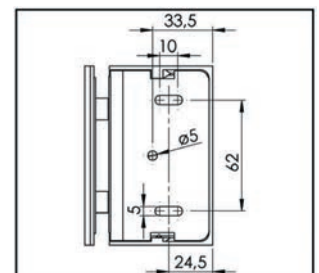
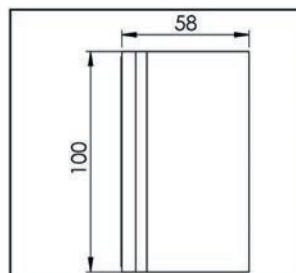

Corner Clamp Bilbao Premium glass/wall 90°



FINISH	ART. NO.
shiny chrome-plated	BO 5211569N
stainless steel look	BO 5211570N
max. door weight per pair	– kg
max. door height	– mm
max. door width	– mm
material	brass

i Glass thickness 8, 10, 12 mm · Supplied without mounting hardware

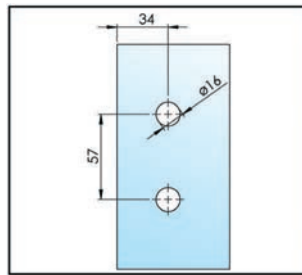
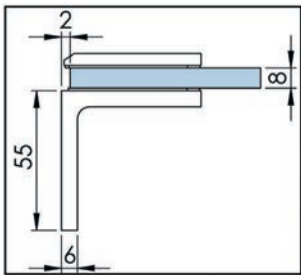
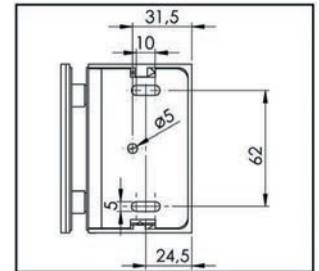
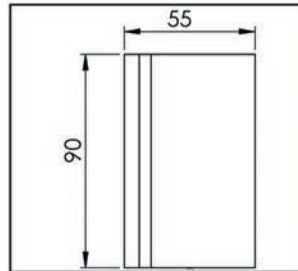

Bohle Bilbao Select Shower Door Hinges

The Bilbao Select shower door hinge series combines modern, square design with useful technical details. Thanks to its versatility and functionality as well as its outstanding price/performance ratio, the Bilbao Select range is popular with builders, planners and architects. Bilbao Select is equipped with a self-closing function starting from an opening angle of approx. $\pm 15^\circ$. Outside this range, the hinge can stop in any position. In addition, the Bilbao Select series benefits from an adjustable zero position, making the alignment of the door much easier for installers.



Shower Door Hinge Bilbao Select glass / wall 90°, one side wall mounted



FINISH	ART. NO.
shiny chrome-plated	BO 5211546
stainless steel look	BO 5211547
max. door weight per pair	40 kg
max. door height	2000 mm
max. door width	1000 mm
material	brass

i Glass thickness 8, 10, 12 mm · Self-closing from 15° · Continuously adjustable zero position · Supplied without mounting hardware

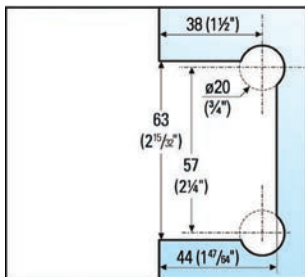
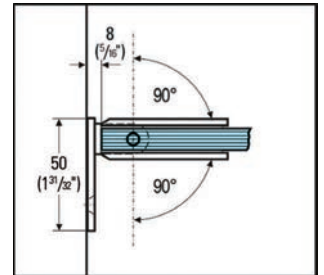
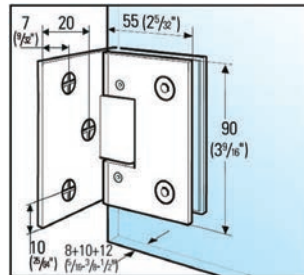

Shower Door Hinge Bilbao Select glass / wall 90°, both sides wall mounted



FINISH	ART. NO.
shiny chrome-plated	BO 5211516
stainless steel look	BO 5211517
max. door weight per pair	40 kg
max. door height	2000 mm
max. door width	1000 mm
material	brass

i Glass thickness 8, 10, 12 mm · Self-closing from 15° · Continuously adjustable zero position · Supplied without mounting hardware

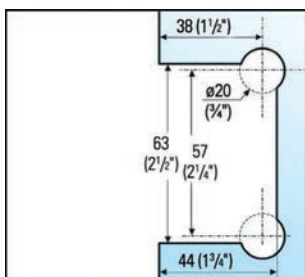
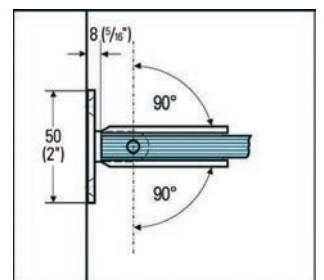
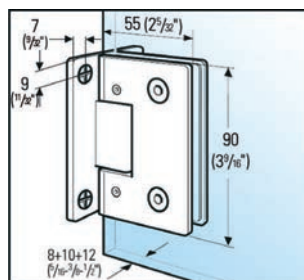

Shower Door Hinge Bilbao Select glass/glass 90°



FINISH	ART. NO.
shiny chrome-plated	BO 5211806
max. door weight per pair	40 kg
max. door height	2000 mm
max. door width	1000 mm
material	brass

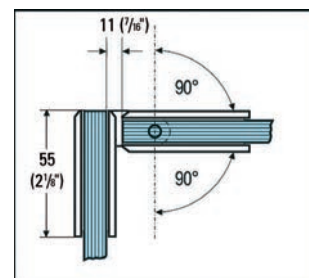
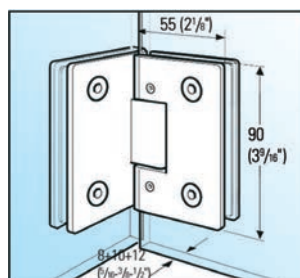

i Glass thickness 8, 10, 12 mm · Self-closing from 15° · Continuously adjustable zero position · For mounting doors to a fixed sidelight

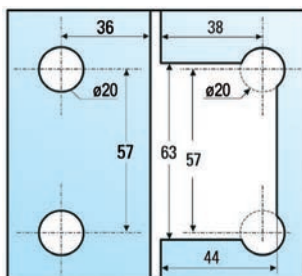

Shower Door Hinge Bilbao Select glass/glass 135°



FINISH	ART. NO.
shiny chrome-plated	BO 5211906
max. door weight per pair	40 kg
max. door height	2000 mm
max. door width	1000 mm
material	brass

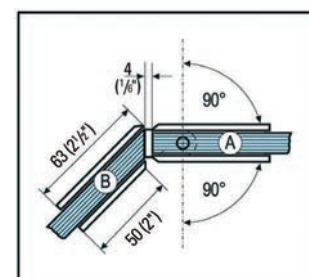
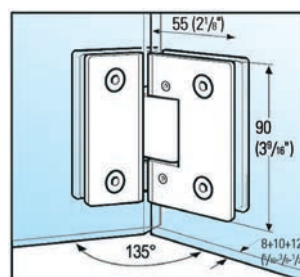

i Glass thickness 8, 10, 12 mm · Self-closing from 15° · Continuously adjustable zero position · For mounting doors to a fixed sidelight

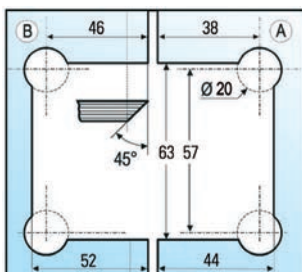

Shower Door Hinge Bilbao Select glass/glass 180°

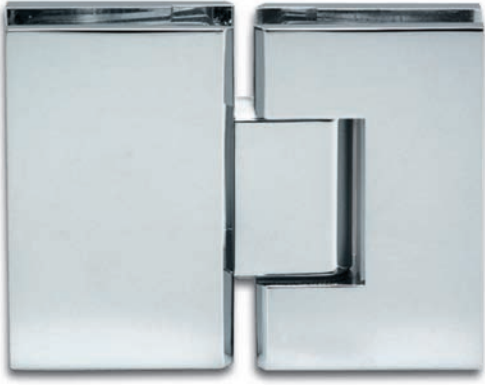

i Glass thickness 8, 10, 12 mm · Self-closing from 15° · Continuously adjustable zero position · For mounting doors to a fixed sidelight

FINISH	ART. NO.
shiny chrome-plated	BO 5211716
stainless steel look	BO 5211717
<hr/>	
max. door weight per pair	40 kg
max. door height	2000 mm
max. door width	1000 mm
material	brass

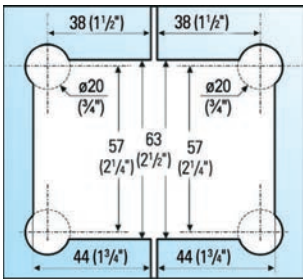
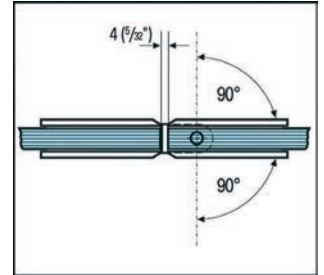
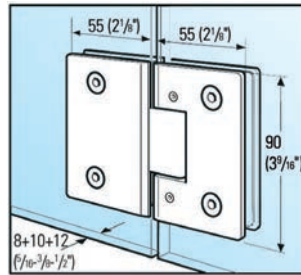

Connector Bilbao glass/wall 90°



i Glass thickness 8, 10, 12 mm · Supplied without mounting hardware · For fixed partitions

FINISH	ART. NO.
shiny chrome-plated	BO 5218420
stainless steel look	BO 5218421
<hr/>	
max. door weight per pair	– kg
max. door height	– mm
max. door width	– mm
material	brass

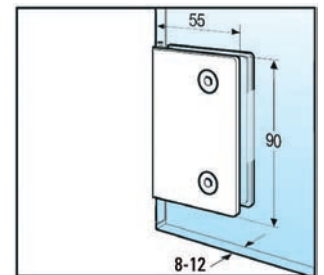
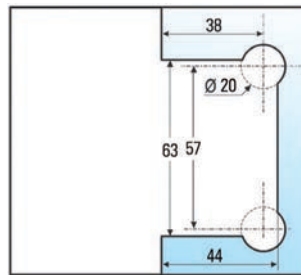

Corner Clamp Bilbao glass/wall 90°



FINISH	ART. NO.
shiny chrome-plated	BO 5213142
stainless steel look	BO 5213143
max. door weight per pair	– kg
max. door height	– mm
max. door width	– mm
material	brass

i Glass thickness 8, 10, 12 mm · Supplied without mounting hardware · For fixed partitions

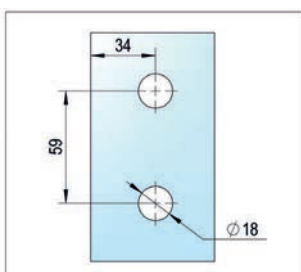
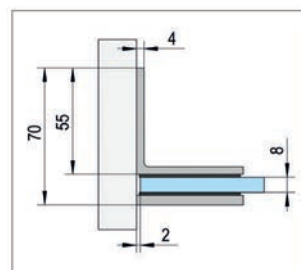
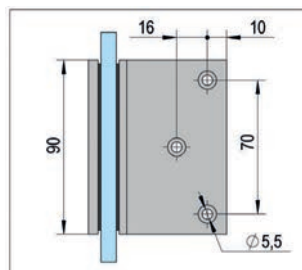

Corner Clamp Bilbao glass/glass 90°



FINISH	ART. NO.
shiny chrome-plated	BO 5213152
stainless steel look	BO 5213153
max. door weight per pair	– kg
max. door height	– mm
max. door width	– mm
material	brass

i Glass thickness 8, 10, 12 mm · For fixed partitions

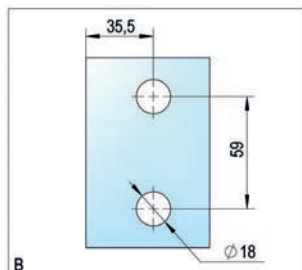
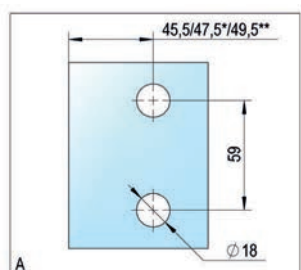
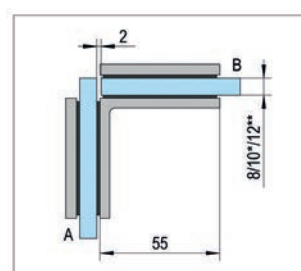
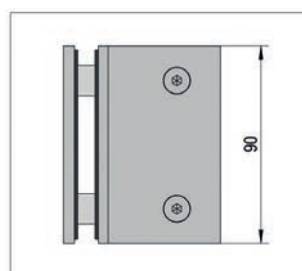

Side Connector Bilbao glass/glass 180°



FINISH	ART. NO.
shiny chrome-plated	BO 5213162
stainless steel look	BO 5213163
max. door weight per pair	– kg
max. door height	– mm
max. door width	– mm
material	brass

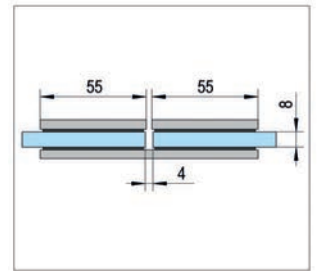
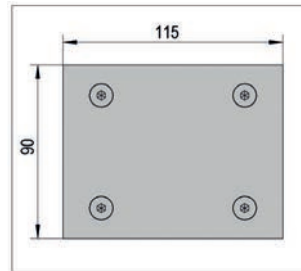

i Glass thickness 8, 10, 12 mm · For fixed partitions

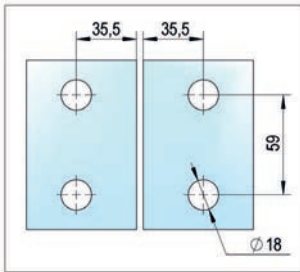

The Bilbao Select, Aqua and Milano Original shower door hinges are now available in a black finish. We also offer suitable reinforcement bars and handles.

You will find the complete product range in our new brochure Black Diamonds.

Please contact our Customer Service Department on 0800 616151 or info@bohle.ltd.uk for more information!

Bohle Bilbao Shower Door Hinges

The Bilbao shower door hinge series combines modern, square design with useful technical details. Thanks to its versatility and functionality as well as its outstanding price/performance ratio, the Bilbao range is popular with builders, planners and architects. Bilbao is equipped with a self-closing function starting from an opening angle of approx. +/-15°. Outside this range, the hinge can stop in any position.

Shower Door Hinge Bilbao glass/wall 90°, one side wall mounted



i Glass thickness 8, 10, 12 mm · Self-closing from 15° · Supplied without mounting hardware

FINISH	ART. NO.
shiny chrome-plated	BO 5211549
stainless steel look	BO 5211550
max. door weight per pair	36 kg
max. door height	2000 mm
max. door width	900 mm
material	brass

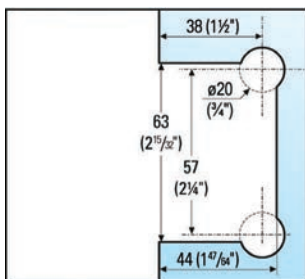
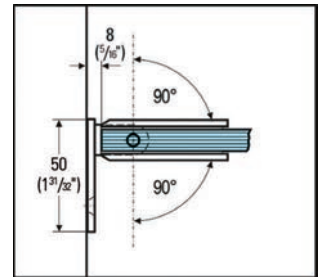
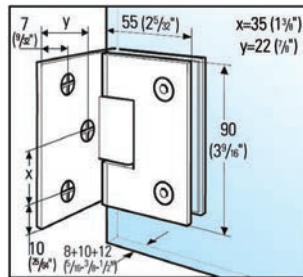

Shower Door Hinge Bilbao glass/glass 180°

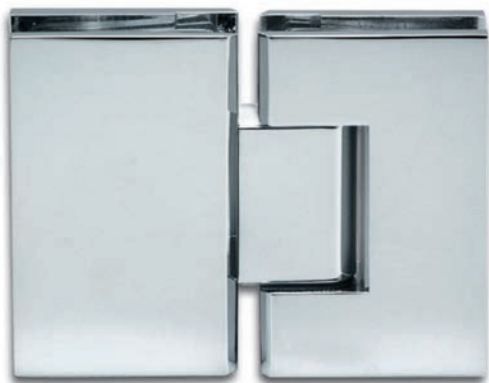

i Glass thickness 8, 10, 12 mm · Self-closing from 15° · For mounting doors to a fixed sidelight

FINISH	ART. NO.
shiny chrome-plated	BO 5218210
stainless steel look	BO 5218211

max. door weight per pair	36 kg
max. door height	2000 mm
max. door width	900 mm
material	brass

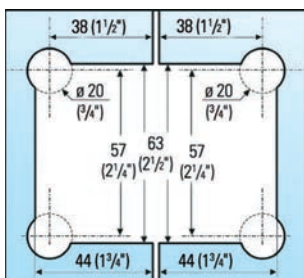
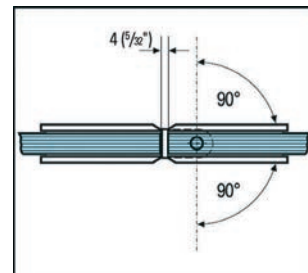
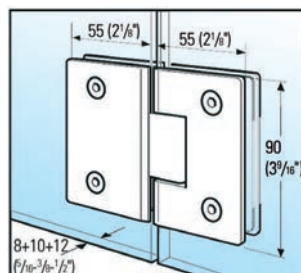

Connector Bilbao glass/wall 90°



i Glass thickness 8, 10, 12 mm · Supplied without mounting hardware · For fixed partitions

FINISH	ART. NO.
shiny chrome-plated	BO 5218420
stainless steel look	BO 5218421

max. door weight per pair	– kg
max. door height	– mm
max. door width	– mm
material	brass

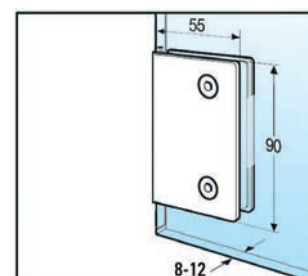
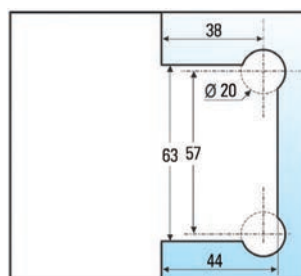

Corner Clamp Bilbao glass/wall 90°



FINISH	ART. NO.
shiny chrome-plated	BO 5213142
stainless steel look	BO 5213143
max. door weight per pair	– kg
max. door height	– mm
max. door width	– mm
material	brass

i Glass thickness 8, 10, 12 mm · Supplied without mounting hardware · For fixed partitions

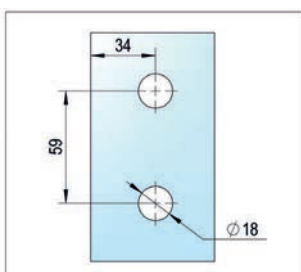
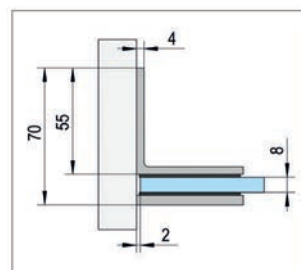
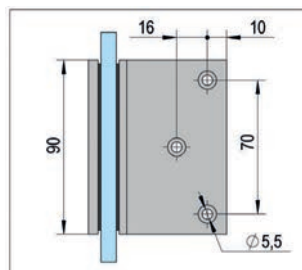

Corner Clamp Bilbao glass/glass 90°



FINISH	ART. NO.
shiny chrome-plated	BO 5213152
stainless steel look	BO 5213153
max. door weight per pair	– kg
max. door height	– mm
max. door width	– mm
material	brass

i Glass thickness 8, 10, 12 mm · For fixed partitions

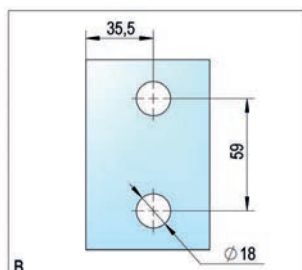
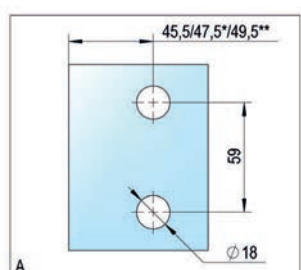
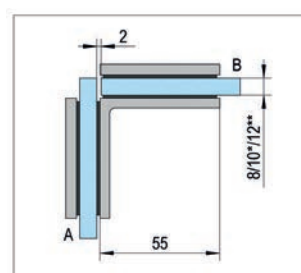
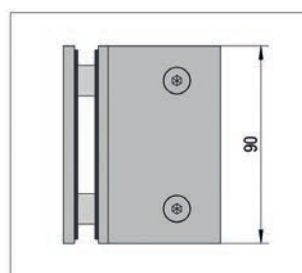

Side Connector Bilbao glass/glass 180°



FINISH	ART. NO.
shiny chrome-plated	BO 5213162
stainless steel look	BO 5213163
max. door weight per pair	– kg
max. door height	– mm
max. door width	– mm
material	brass

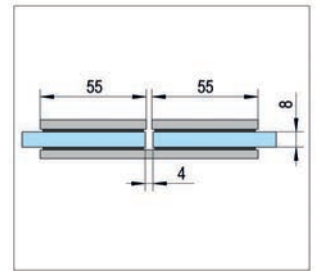
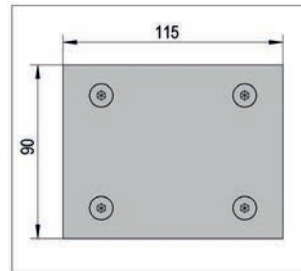

i Glass thickness 8, 10, 12 mm · For fixed partitions

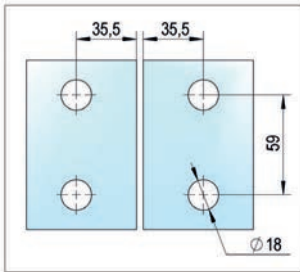

Bohle Barcelona Select Shower Door Hinges

Barcelona Select makes the perfect shower door hinge for the comfortable family bathroom. The harmonious design with rounded-off edges is versatile in use. Barcelona Select is also extremely sturdy and highly functional. Barcelona Select is equipped with a self-closing function starting from an opening angle of approx. $\pm 15^\circ$. Outside this range, the hinge can stop in any position. Unlike Barcelona Basic, Barcelona Select offers an adjustable zero position, making the alignment of the door much easier for installers.



Shower Door Hinge Barcelona Select glass / wall 90°, one side wall mounted



FINISH	ART. NO.
shiny chrome-plated	BO 5219110
stainless steel look	BO 5219111
max. door weight per pair	40 kg
max. door height	2000 mm
max. door width	1000 mm
material	brass

i Glass thickness 8, 10, 12 mm · Self-closing from 15° · Continuously adjustable zero position · Supplied without mounting hardware

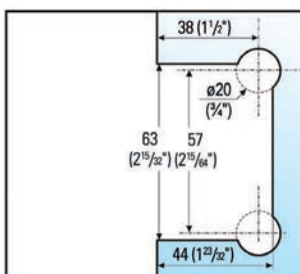
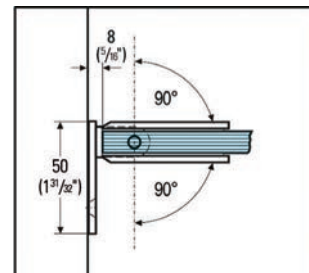
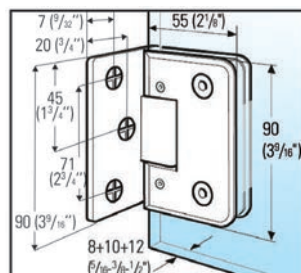

Shower Door Hinge Barcelona Select glass/wall 90°, both sides wall mounted



FINISH	ART. NO.
shiny chrome-plated	BO 5219114
stainless steel look	BO 5219115
max. door weight per pair	40 kg
max. door height	2000 mm
max. door width	1000 mm
material	brass

i Glass thickness 8, 10, 12 mm · Self-closing from 15° · Continuously adjustable zero position · Supplied without mounting hardware

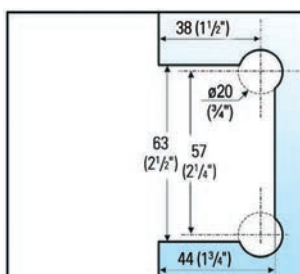
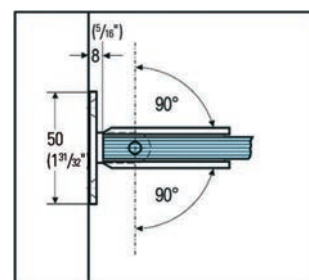
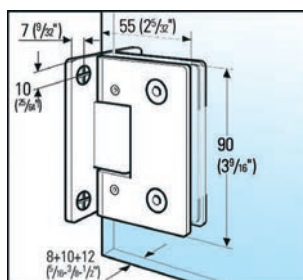

Shower Door Hinge Barcelona Select glass/wall 90°, divided mounting plate



FINISH	ART. NO.
shiny chrome-plated	BO 5219130
stainless steel look	BO 5219131
max. door weight per pair	40 kg
max. door height	2000 mm
max. door width	1000 mm
material	brass

i Glass thickness 8, 10, 12 mm · Self-closing from 15° · Continuously adjustable zero position · Supplied without mounting hardware

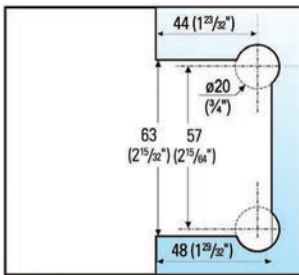
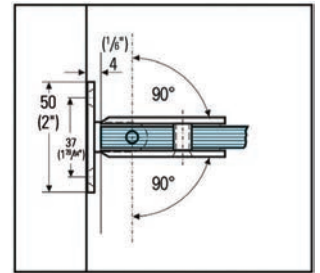
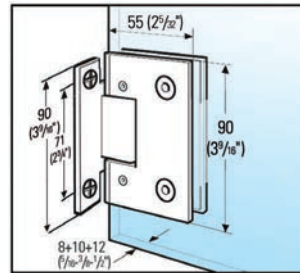

Shower Door Hinge Barcelona Select glass/glass 180°



FINISH	ART. NO.
shiny chrome-plated	BO 5219118
stainless steel look	BO 5219119
max. door weight per pair	40 kg
max. door height	2000 mm
max. door width	1000 mm
material	brass

i Glass thickness 8, 10, 12 mm · Self-closing from 15° · Continuously adjustable zero position · For mounting doors to a fixed sidelight

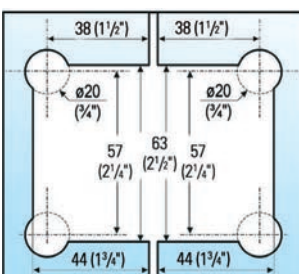
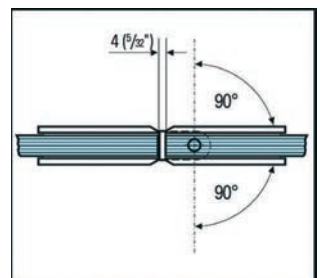
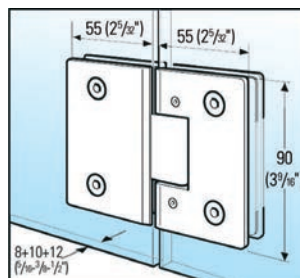

Shower Door Hinge Barcelona Select glass/glass 135°



FINISH	ART. NO.
shiny chrome-plated	BO 5219122
max. door weight per pair	40 kg
max. door height	2000 mm
max. door width	1000 mm
material	brass

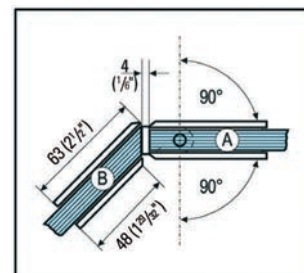
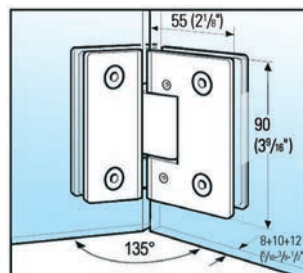

i Glass thickness 8, 10, 12 mm · Self-closing from 15° · Continuously adjustable zero position · For mounting doors to a fixed sidelight

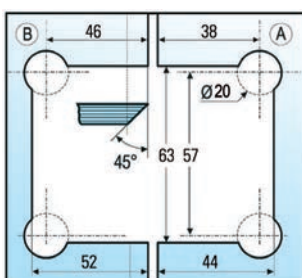

Shower Door Hinge Barcelona Select glass/glass 90°



FINISH	ART. NO.
shiny chrome-plated	BO 5219126
max. door weight per pair	40 kg
max. door height	2000 mm
max. door width	1000 mm
material	brass

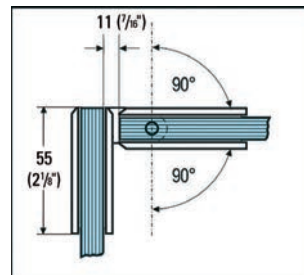
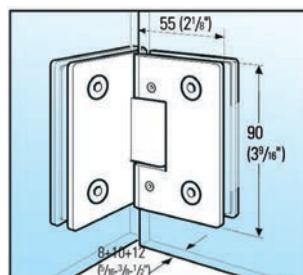

i Glass thickness 8, 10, 12 mm · Self-closing from 15° · Continuously adjustable zero position · For mounting doors to a fixed sidelight

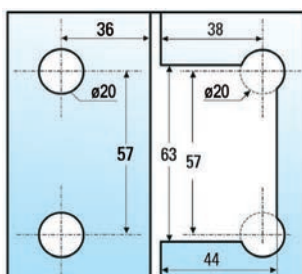

Connector Barcelona glass/wall 90°



i Glass thickness 8, 10, 12 mm · Supplied without mounting hardware · For fixed partitions

FINISH	ART. NO.
shiny chrome-plated	BO 5219050
stainless steel look	BO 5219051
max. door weight per pair	– kg
max. door height	– mm
max. door width	– mm
material	brass

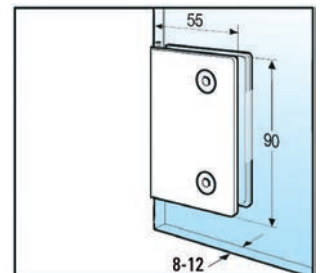
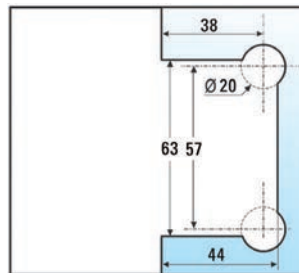

Corner Clamp Barcelona glass/glass 90°



i Glass thickness 8, 10, 12 mm · For fixed partitions · x = glass thickness

FINISH	ART. NO.
shiny chrome-plated	BO 5219060
stainless steel look	BO 5219061
max. door weight per pair	– kg
max. door height	– mm
max. door width	– mm
material	brass

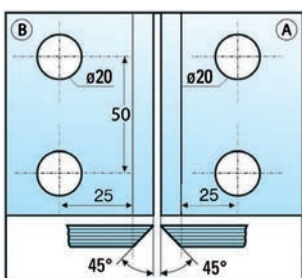
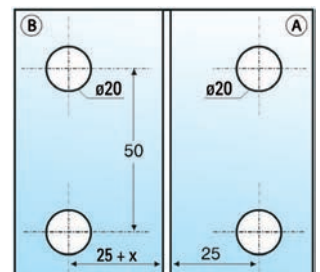
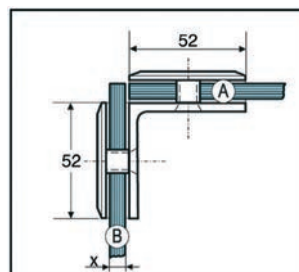

Corner Clamp Barcelona glass/wall 90°



FINISH	ART. NO.
shiny chrome-plated	BO 5219080
stainless steel look	BO 5219081
max. door weight per pair	- kg
max. door height	- mm
max. door width	- mm
material	brass

i Glass thickness 8, 10, 12 mm · Supplied without mounting hardware · For fixed partitions

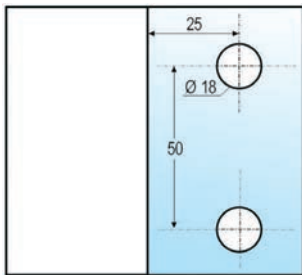
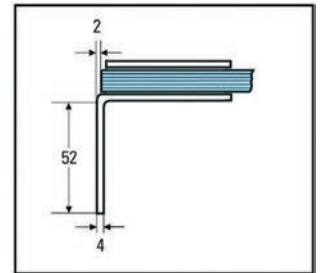
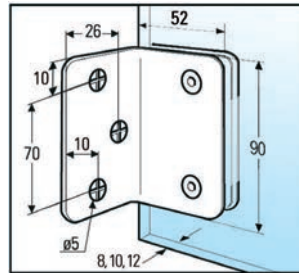

Bohle Barcelona Shower Door Hinges

Barcelona makes the perfect shower door hinge for the comfortable family bathroom. The harmonious design with rounded-off edges is versatile in use. Barcelona is also extremely sturdy and highly functional. Barcelona is equipped with a self-closing function starting from an opening angle of approx. +/-15°. Outside this range, the hinge can stop in any position.

Shower Door Hinge Barcelona glass/wall 90°, one side wall mounted



i Glass thickness 8, 10, 12 mm · Self-closing from 15° · Supplied without mounting hardware

FINISH	ART. NO.
shiny chrome-plated	BO 5218110
stainless steel look	BO 5218111

max. door weight per pair	36 kg
max. door height	2000 mm
max. door width	900 mm
material	brass

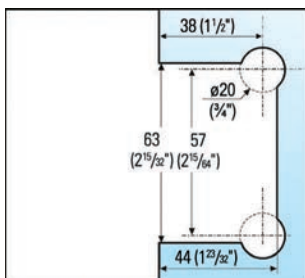
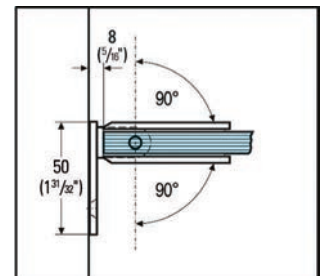
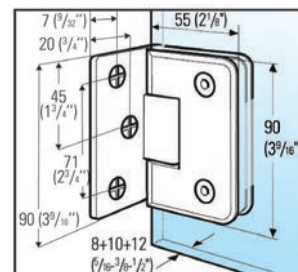

Shower Door Hinge Barcelona glass/wall 90°, both sides wall mounted



FINISH	ART. NO.
shiny chrome-plated	BO 5219010
stainless steel look	BO 5219011
max. door weight per pair	36 kg
max. door height	2000 mm
max. door width	900 mm
material	brass

i Glass thickness 8, 10, 12 mm · Self-closing from 15° · Supplied without mounting hardware

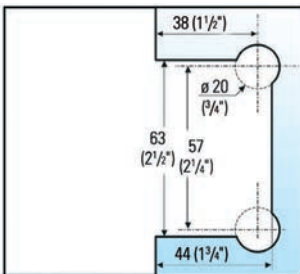
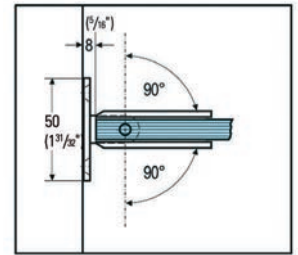
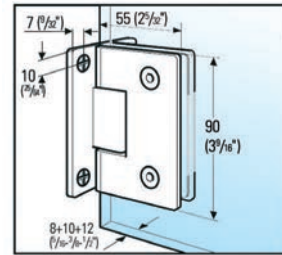

Shower Door Hinge Barcelona glass/glass 180°



FINISH	ART. NO.
shiny chrome-plated	BO 5219210
stainless steel look	BO 5219211
max. door weight per pair	36 kg
max. door height	2000 mm
max. door width	900 mm
material	brass

i For mounting doors to a fixed sidelight · Glass thickness 8, 10, 12 mm · Self-closing from 15°

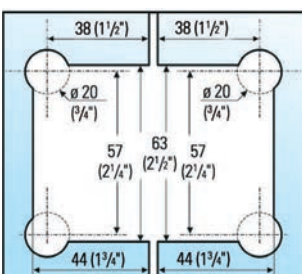
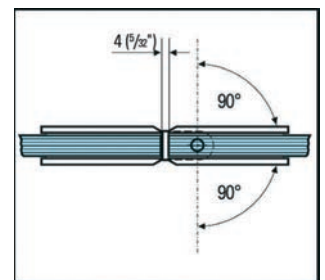
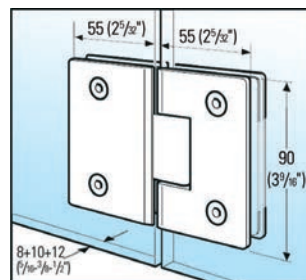

Connector Barcelona glass/wall 90°



i Glass thickness 8, 10, 12 mm · Supplied without mounting hardware · For fixed partitions

FINISH	ART. NO.
shiny chrome-plated	BO 5219050
stainless steel look	BO 5219051
max. door weight per pair	– kg
max. door height	– mm
max. door width	– mm
material	brass

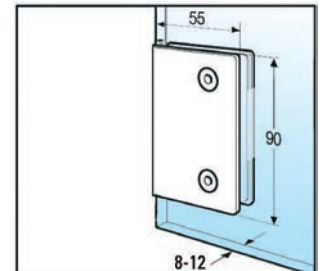
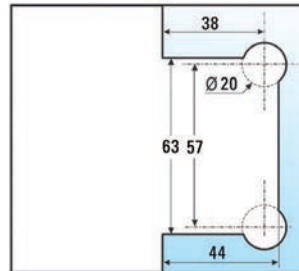

Corner Clamp Barcelona glass/glass 90°



i Glass thickness 8, 10, 12 mm · For fixed partitions · x = glass thickness

FINISH	ART. NO.
shiny chrome-plated	BO 5219060
stainless steel look	BO 5219061
max. door weight per pair	– kg
max. door height	– mm
max. door width	– mm
material	brass

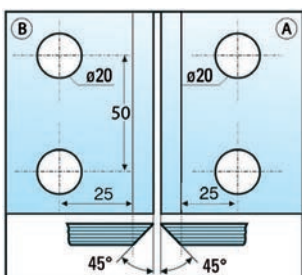
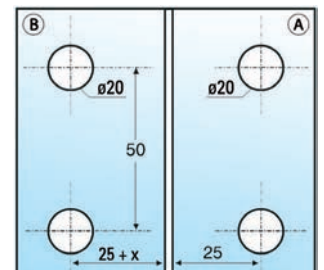
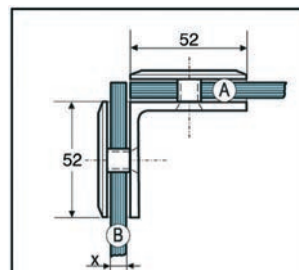

Corner Clamp Barcelona glass/wall 90°



FINISH	ART. NO.
shiny chrome-plated	BO 5219080
stainless steel look	BO 5219081
max. door weight per pair	– kg
max. door height	– mm
max. door width	– mm
material	brass

i Glass thickness 8, 10, 12 mm · Supplied without mounting hardware · For fixed partitions

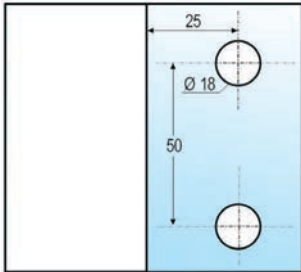
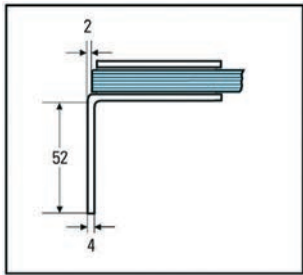
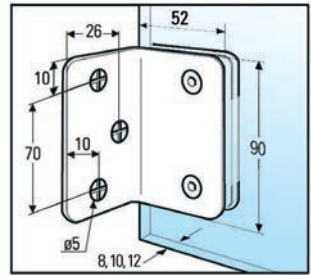

Milano Original Shower Door Hinges

The Milano Original remains impressive, despite its smaller size. This swinging door hinge has covers on both sides so that hardly any screws can be seen. Its angular design lends a modern appearance to any bathroom. The zero position can be adjusted infinitely. Maximum door weight per pair of hinges: 50 kg, maximum door width 1000 mm. In general, Milano Original shower door hinges can be mounted without sealing strips, however, this may lead to increased water leakage.



Shower Door Hinge Milano Original glass/wall 90°, one side wall mounted



FINISH	ART. NO.
shiny chrome-plated	BK 0781231
stainless steel look	BK 0781255
max. door weight per pair	50 kg
max. door height	2250 mm
max. door width	1000 mm (8 mm)
material	brass

i Glass thickness 8, 10 mm · max. door width (for 10 mm glass) 850 mm. · Self-closing function · Continuously adjustable zero position

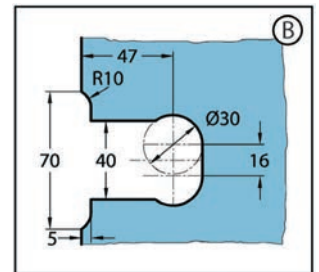
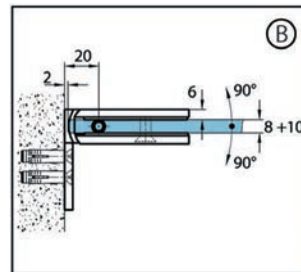
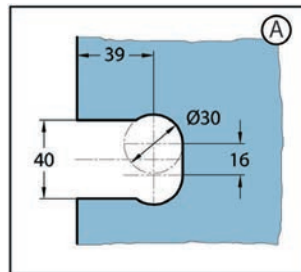
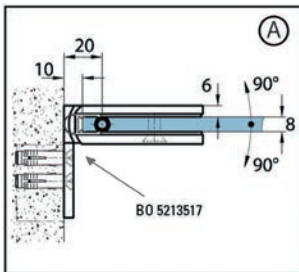
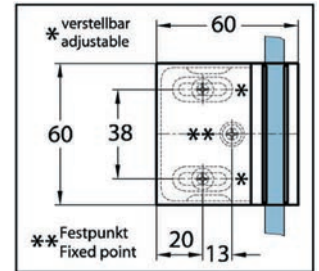
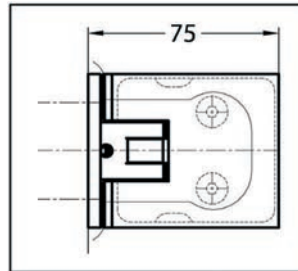

Shower Door Hinge Milano Original glass/glass 180°



FINISH	ART. NO.
shiny chrome-plated	BK 0783031
stainless steel look	BK 0783055
max. door weight per pair	50 kg
max. door height	2250 mm
max. door width	1000 mm (8 mm)
material	brass

i Glass thickness 8, 10 mm · max. door width (for 10 mm glass) 850 mm. · Self-closing function · Continuously adjustable zero position

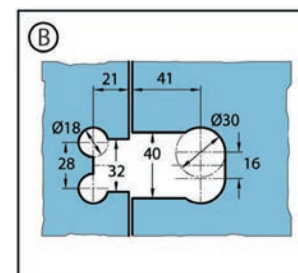
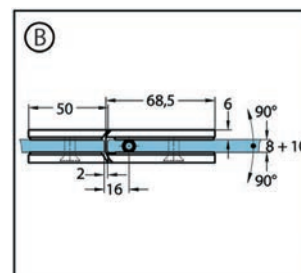
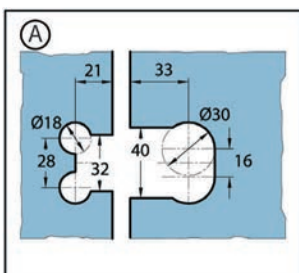
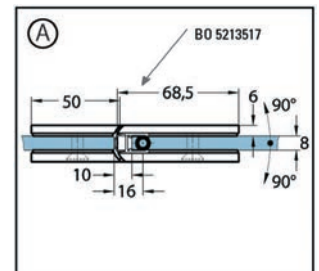
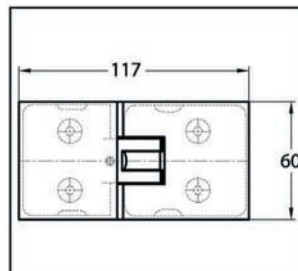

Shower Door Hinge Milano Original glass/glass 90°



FINISH	ART. NO.
shiny chrome-plated	BK 0784031
max. door weight per pair	50 kg
max. door height	2250 mm
max. door width	1000 mm (8 mm)
material	brass

① Glass thickness 8, 10 mm · max. door width (for 10 mm glass) 850 mm. · Self-closing function · Continuously adjustable zero position

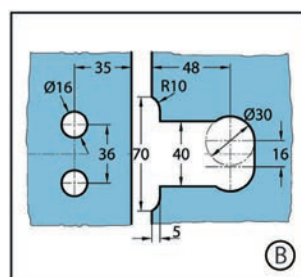
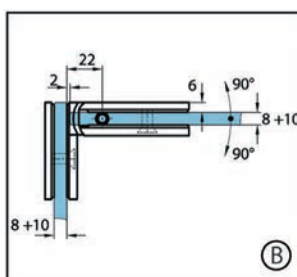
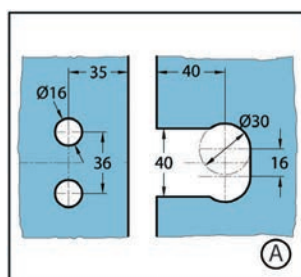
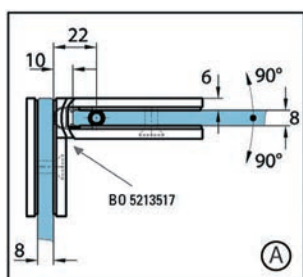
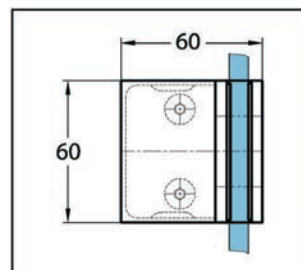
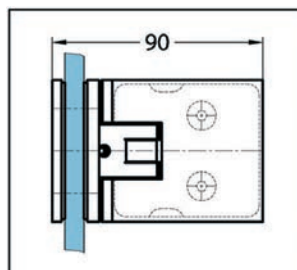

Shower Door Hinge Milano Original glass/glass 135°



FINISH	ART. NO.
shiny chrome-plated	BK 0787031
max. door weight per pair	50 kg
max. door height	2250 mm
max. door width	1000 mm (8 mm)
material	brass

① Glass thickness 8, 10 mm · max. door width (for 10 mm glass) 850 mm. · Self-closing function · Continuously adjustable zero position

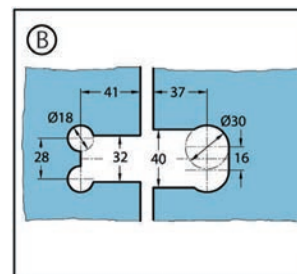
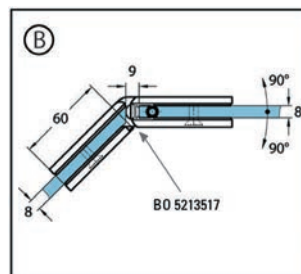
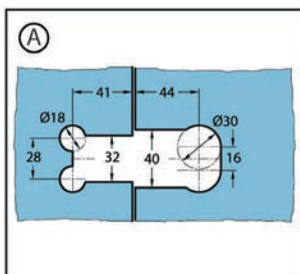
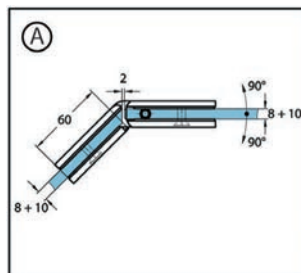
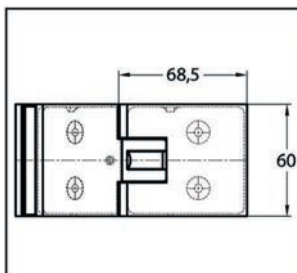

Corner Clamp Milano Original / Milano Premium glass/wall 90°



FINISH	ART. NO.
shiny chrome-plated	BK 0749031
stainless steel look	BK 0749055
max. door weight per pair	– kg
max. door height	– mm
max. door width	– mm
material	brass

i Glass thickness 8, 10 mm

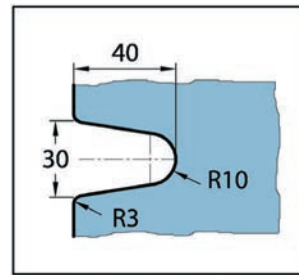
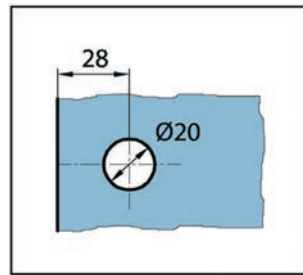
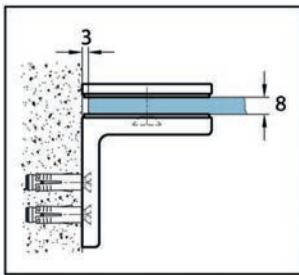
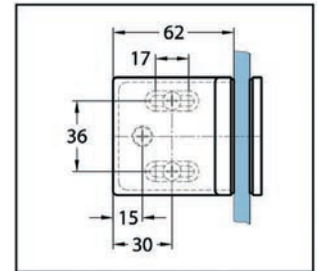
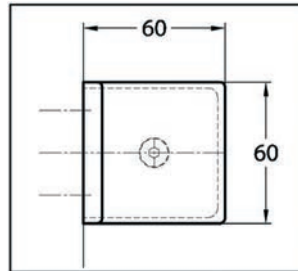

Corner Clamp Milano Original / Milano Premium glass/glass 90°



FINISH	ART. NO.
shiny chrome-plated	BK 0749331
stainless steel look	BK 0749355
max. door weight per pair	– kg
max. door height	– mm
max. door width	– mm
material	brass

i Glass thickness 8, 10 mm

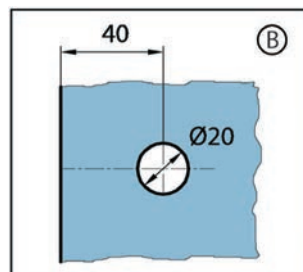
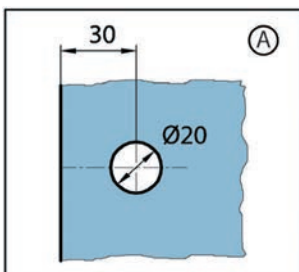
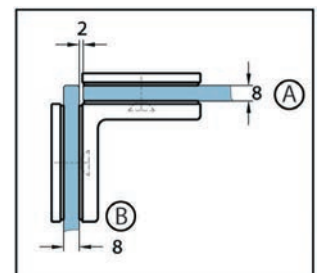
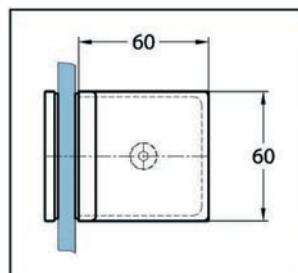

Side Connector Milano Original / Milano Premium glass/glass 180°



FINISH	ART. NO.
shiny chrome-plated	BK 0749931
stainless steel look	BK 0749955
max. door weight per pair	– kg
max. door height	– mm
max. door width	– mm
material	brass

i Glass thickness 8, 10 mm

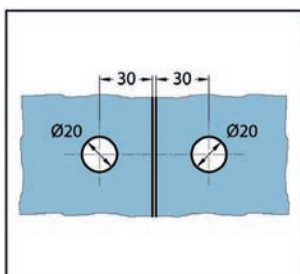
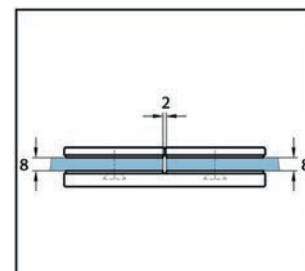
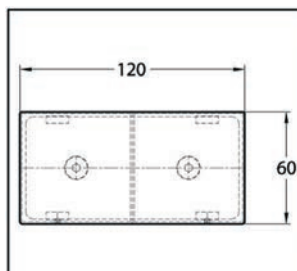

The Bilbao Select, Aqua and Milano Original shower door hinges are now available in a black finish. We also offer suitable reinforcement bars and handles.

You will find the complete product range in our new brochure Black Diamonds.

Please contact our Customer Service Department on 0800 616151 or info@bohle.ltd.uk for more information!

Bohle Europe Shower Door Hinges

The Europe series of shower door hinges was developed by Bohle, taking both functionality and aesthetics into account. This product range has a timeless design which fits perfectly in modern bathrooms. The zero position is adjustable by $\pm 5^\circ$ and can easily be reset at any time. The Europe series is suitable for 8 or 10 mm glass and door weights up to 40 kg with a maximum door width of 1000 mm (for 8 mm glass).



Shower Door Hinge Europe glass/wall 90°, one side wall mounted



FINISH	ART. NO.
shiny chrome-plated	BO 540001
max. door weight per pair	40 kg
max. door height	2000 mm
max. door width	1000 mm
material	zinc

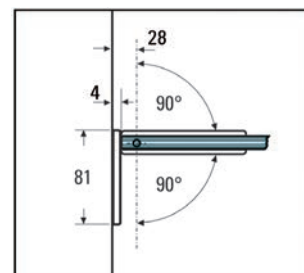
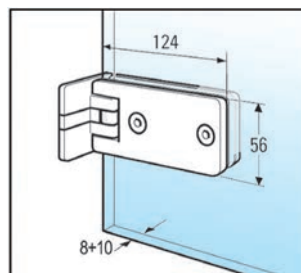

i Glass thickness 8, 10 mm · Zero position adjustable $\pm 5^\circ$ · Supplied without mounting hardware

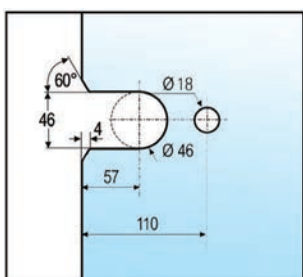

Shower Door Hinge Europe glass/wall 90°, both sides wall mounted



FINISH	ART. NO.
shiny chrome-plated	BO 5400011
max. door weight per pair	40 kg
max. door height	2000 mm
max. door width	1000 mm
material	zinc

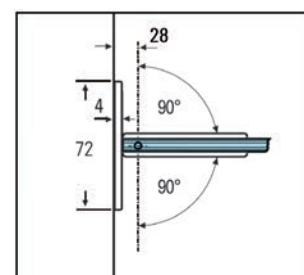
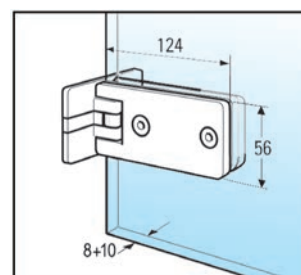

i Glass thickness 8, 10 mm · Zero position adjustable $\pm 5^\circ$ · Supplied without mounting hardware

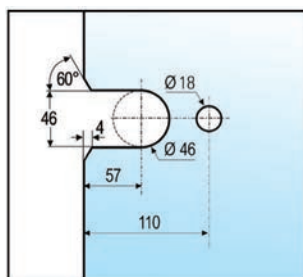

Shower Door Hinge Europe glass/glass 180°



i Glass thickness 8, 10 mm · Zero position adjustable $\pm 5^\circ$ · For mounting doors to a fixed sidelight

FINISH	ART. NO.
shiny chrome-plated	BO 5400021
max. door weight per pair	40 kg
max. door height	2000 mm
max. door width	1000 mm
material	zinc

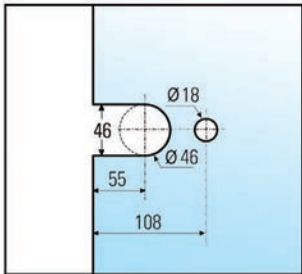
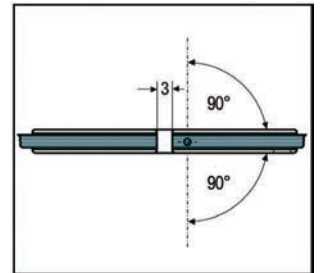
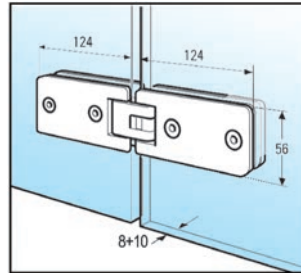

Connector Europe glass/wall 90°



i Glass thickness 8, 10 mm · Supplied without mounting hardware · For vertical partitions

FINISH	ART. NO.
shiny chrome-plated	BO 5400061
max. door weight per pair	– kg
max. door height	– mm
max. door width	– mm
material	brass

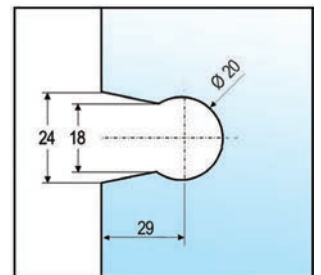
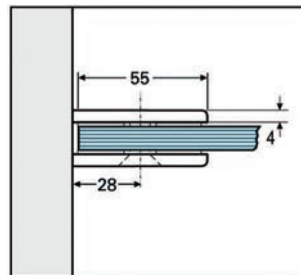

Corner Clamp Europe glass/wall 90°



i Glass thickness 8, 10 mm · Supplied without mounting hardware · For vertical partitions

FINISH	ART. NO.
shiny chrome-plated	BO 5400071
max. door weight per pair	– kg
max. door height	– mm
max. door width	– mm
material	brass

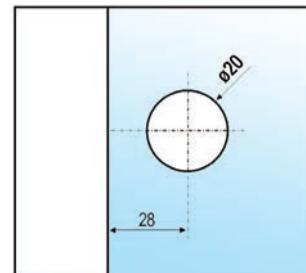
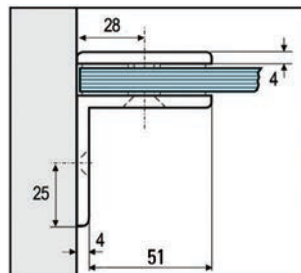

Corner Clamp Europe glass/glass 90°



i Glass thickness 8, 10 mm · For vertical partitions · $x = 29 \text{ mm} + \text{glass thickness}$

FINISH	ART. NO.
shiny chrome-plated	BO 5400081
max. door weight per pair	– kg
max. door height	– mm
max. door width	– mm
material	brass

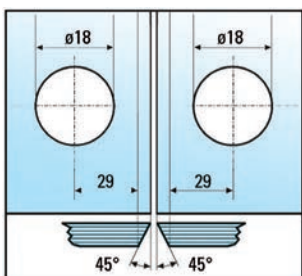
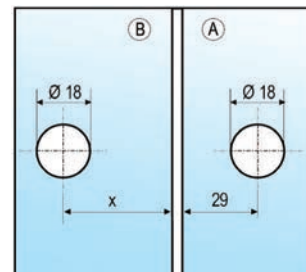
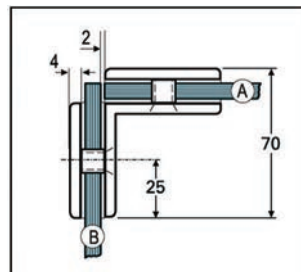

Our Europe shower door hinges are also available with coloured PVD coating. Five different colours with two different surfaces provide a large design selection for planners and architects. Please contact our Customer Service Department on 0800 616151 or info@bohle.ltd.uk for more information!

Bohle Granada Shower Door Hinges

Expressive and highly functional – the Granada shower door hinge has a subtle design. Its horizontal layout with rounded-off edges complements its style perfectly. Granada is equipped with a self-closing function starting from an opening angle of approx. $\pm 15^\circ$. Outside this range, the hinge can stop in any position. In addition, the Granada series offers an adjustable zero position, making the alignment of the door much easier for installers.



Shower Door Hinge Granada glass/wall 90°, one side wall mounted



FINISH	ART. NO.
shiny chrome-plated	BO 5214058
stainless steel look	BO 5214046
max. door weight per pair	35 kg
max. door height	2000 mm
max. door width	900 mm
material	brass

i Glass thickness 8, 10 mm · Self-closing from 15° · Continuously adjustable zero position · Supplied without mounting hardware

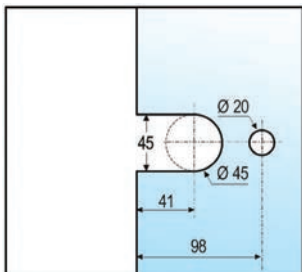
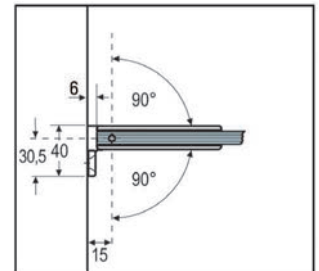
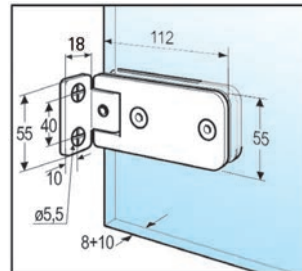

Shower Door Hinge Granada glass/wall 90°, both sides wall mounted



FINISH	ART. NO.
shiny chrome-plated	BO 5214050
stainless steel look	BO 5214045
max. door weight per pair	35 kg
max. door height	2000 mm
max. door width	900 mm
material	brass

i Glass thickness 8, 10 mm · Self-closing from 15° · Continuously adjustable zero position · Supplied without mounting hardware

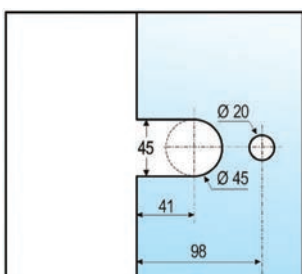
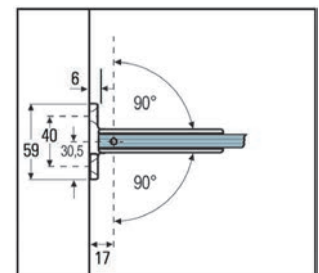
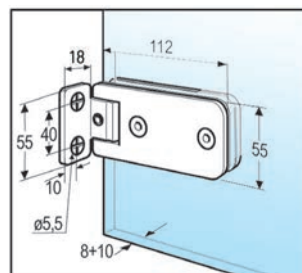

Shower Door Hinge Granada glass/glass 90°



FINISH	ART. NO.
shiny chrome-plated	BO 5214056
stainless steel look	BO 5214049
<hr/>	
max. door weight per pair	35 kg
max. door height	2000 mm
max. door width	900 mm
material	brass

i Glass thickness 8, 10 mm · Self-closing from 15° · Continuously adjustable zero position · For mounting doors to a fixed sidelight

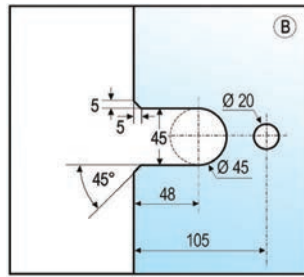
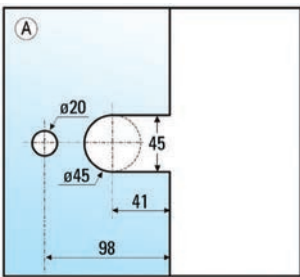
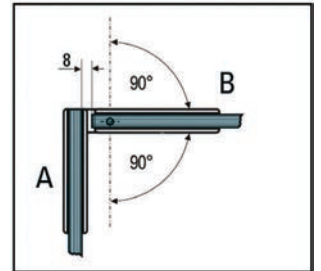
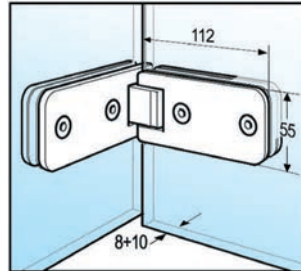

Shower Door Hinge Granada glass/glass 135°



FINISH	ART. NO.
shiny chrome-plated	BO 5214054
stainless steel look	BO 5214048
<hr/>	
max. door weight per pair	35 kg
max. door height	2000 mm
max. door width	900 mm
material	brass

i Glass thickness 8, 10 mm · Self-closing from 15° · Continuously adjustable zero position · For mounting doors to a fixed sidelight

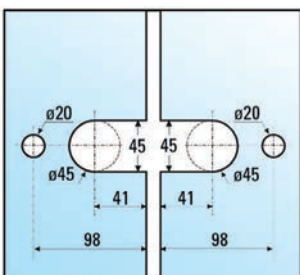
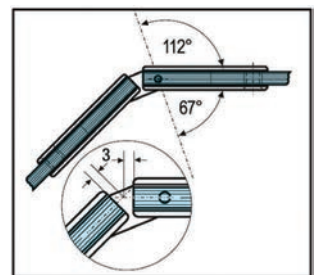
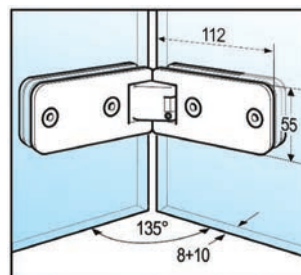

Shower Door Hinge Granada glass/glass 180°



i Glass thickness 8, 10 mm · Self-closing from 15° · Continuously adjustable zero position · For mounting doors to a fixed sidelight

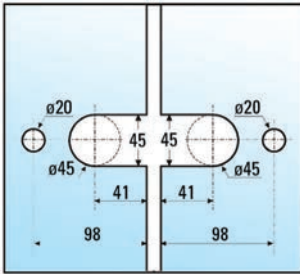

FINISH	ART. NO.
shiny chrome-plated	BO 5214052
stainless steel look	BO 5214047
max. door weight per pair	35 kg
max. door height	2000 mm
max. door width	900 mm
material	brass

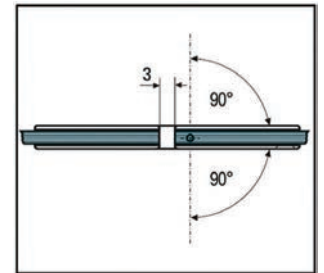
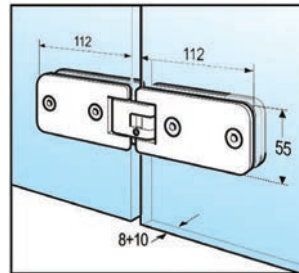

Corner Clamp Granada glass/wall 90°



i Glass thickness 8, 10 mm · Supplied without mounting hardware

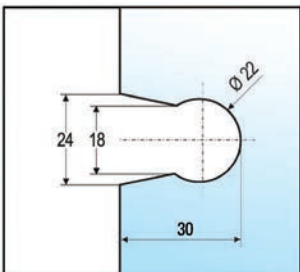

FINISH	ART. NO.
shiny chrome-plated	BO 5213116
stainless steel look	BO 5213115
max. door weight per pair	– kg
max. door height	– mm
max. door width	– mm
material	brass

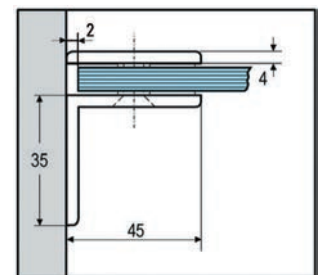
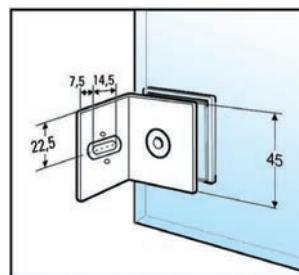

Corner Clamp Granada glass/glass 90°



i Glass thickness 8, 10 mm · For vertical partitions

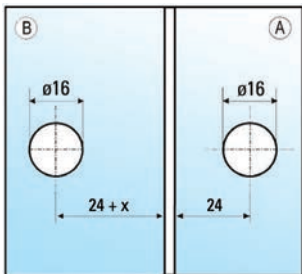

FINISH	ART. NO.
shiny chrome-plated	BO 5213622
max. door weight per pair	– kg
max. door height	– mm
max. door width	– mm
material	brass

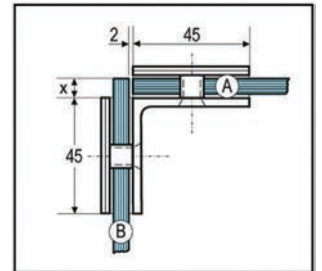
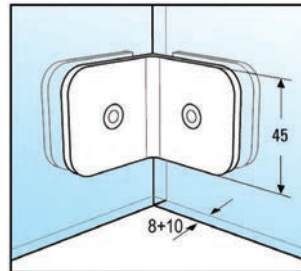

Connector Granada 90° glass/wall



i For vertical partitions

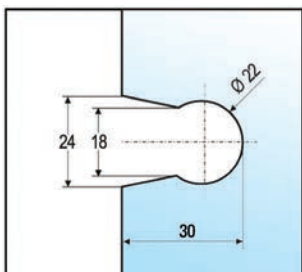

FINISH	ART. NO.
stainless steel look	BO 5213605
shiny chrome-plated	BO 5213606
material	brass

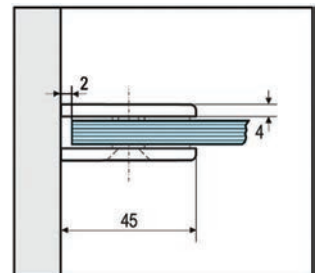
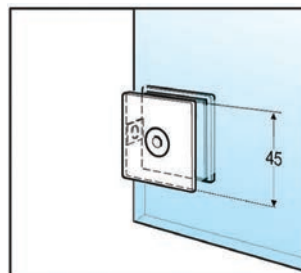

Next Shower Door Hinges

Perfection down to the last detail – the square-angled design of the Next shower door hinge gives the hinge a minimalistic look which perfectly integrates into modern bathroom settings. Both the screws of the wall fixing and the screws on the hinge are concealed – so nothing interferes with the minimalistic design. The integrated rise and fall function provides supreme comfort.



Shower Door Hinge Next glass/wall 90° DIN right



FINISH	ART. NO.
shiny chrome-plated	BK 8141231
max. door weight per pair	40 kg
max. door height	2250 mm
max. door width	900 mm
material	brass

i Glass thickness 8, 10 mm · Lifting height 5 mm · Elongated hole for wall mounting

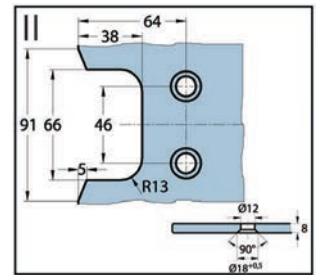
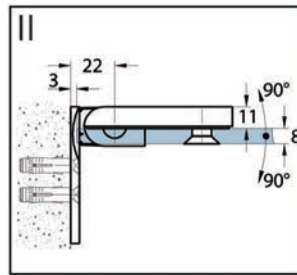
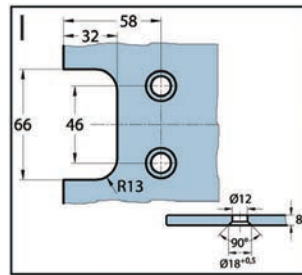
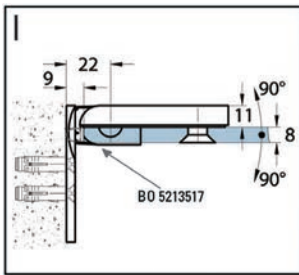
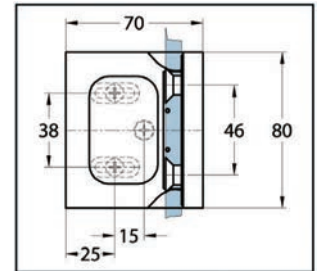
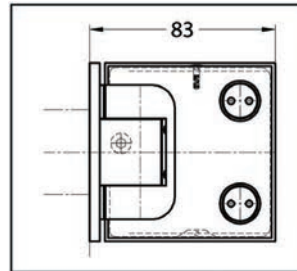

Shower Door Hinge Next glass/wall 90° DIN left



FINISH	ART. NO.
shiny chrome-plated	BK 8141331
max. door weight per pair	40 kg
max. door height	2250 mm
max. door width	900 mm
material	brass

i Glass thickness 8, 10 mm · Lifting height 5 mm · Elongated hole for wall mounting

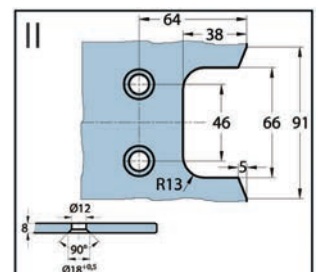
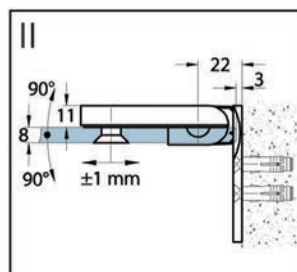
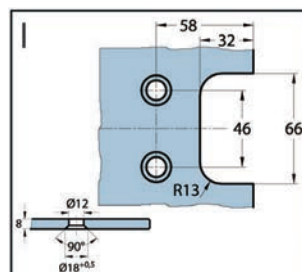
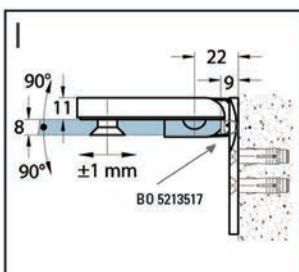
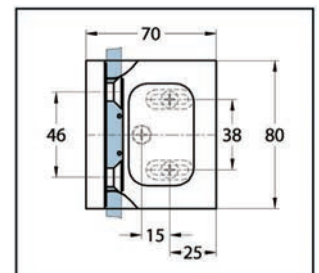
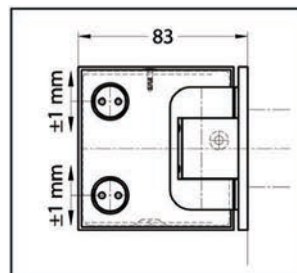

Shower Door Hinge Next glass/glass 180° DIN right



FINISH	ART. NO.
shiny chrome-plated	BK 8143031
max. door weight per pair	40 kg
max. door height	2250 mm
max. door width	900 mm
material	brass

i Glass thickness 8, 10 mm · Lifting height 5 mm

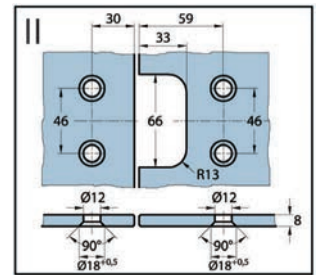
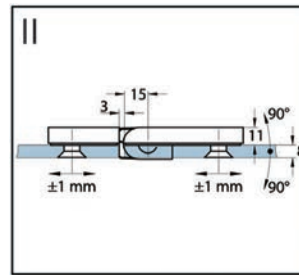
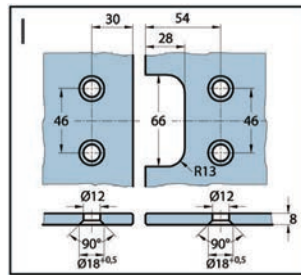
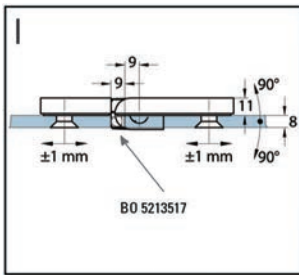
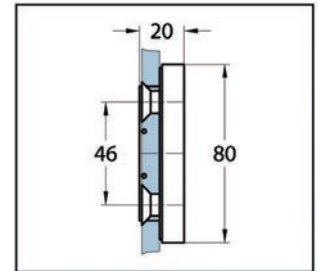
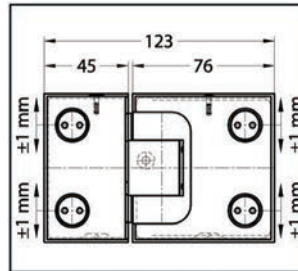

Shower Door Hinge Next glass/glass 180° DIN left



FINISH	ART. NO.
shiny chrome-plated	BK 8143131
max. door weight per pair	40 kg
max. door height	2250 mm
max. door width	900 mm
material	brass

i Glass thickness 8, 10 mm · Lifting height 5 mm

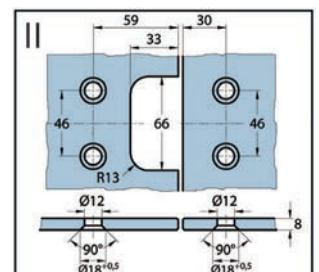
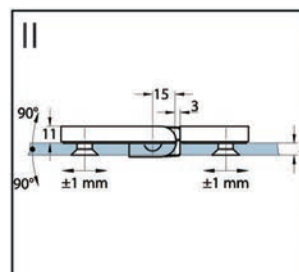
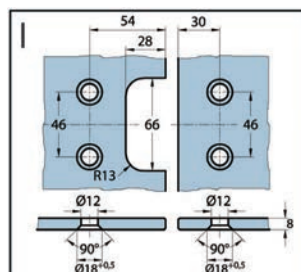
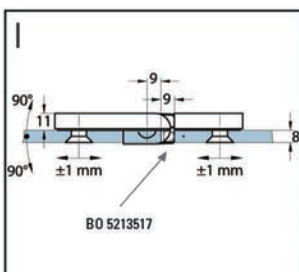
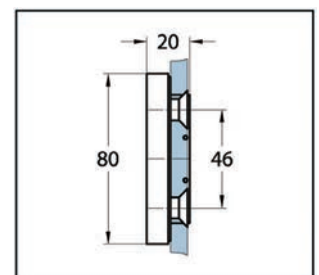
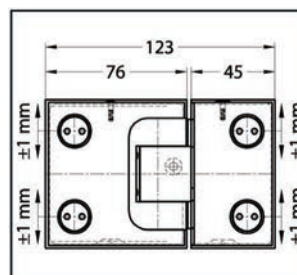

Corner Clamp Next glass/wall 90°

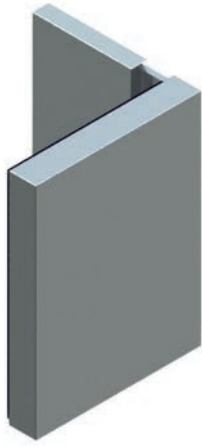

FINISH	ART. NO.
shiny chrome-plated	BK 8149131
max. door weight per pair	- kg
max. door height	- mm
max. door width	- mm
material	brass

i Glass thickness 8, 10 mm

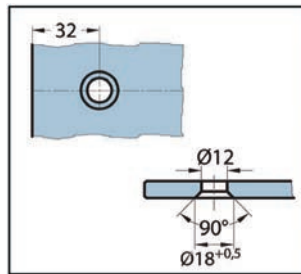
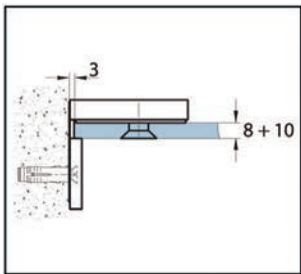
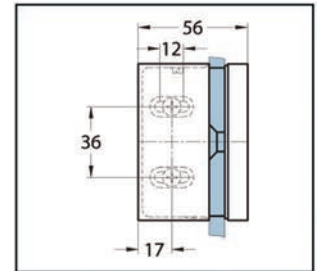
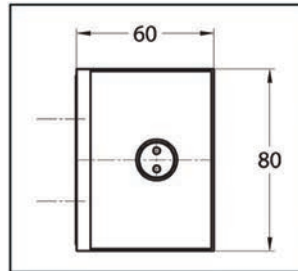

Plan Artist Shower Door Hinges

Even double doors can be opened inwards and outwards with Plan artist. The perfect solution for barrier-free showers or sophisticated bathroom design in limited spaces. The Plan artist shower door hinges are flush on the inside and equipped with the unique rise and fall mechanism. Plan artist shower door fittings must always be mounted together with sealing strips, which can be guided through the hinge.



Shower Door Hinge Plan Artist glass/wall 90° DIN left



FINISH	ART. NO.
shiny chrome-plated	BO 5215601
stainless steel look	BO 5215603

max. door weight per pair	38 kg
max. door height	2100 mm
max. door width	900 mm
material	brass

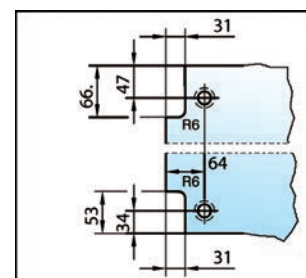
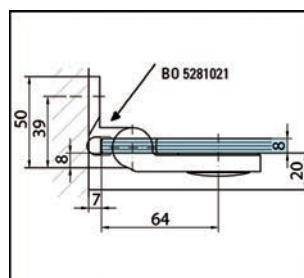

i Glass thickness 8 mm · Lifting height 5 mm · The deduction dimension of 13 mm has already been taken into account in the glass cut-out for inserting the water deflector BO 5213494. If another water deflector is used, the cut-out must be adapted accordingly.

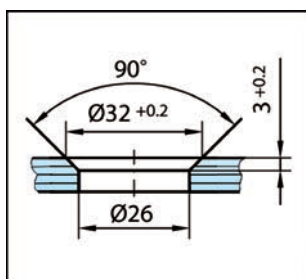

Shower Door Hinge Plan Artist glass/wall 90° DIN right



FINISH	ART. NO.
shiny chrome-plated	BO 5215604
stainless steel look	BO 5215606

max. door weight per pair	38 kg
max. door height	2100 mm
max. door width	900 mm
material	brass

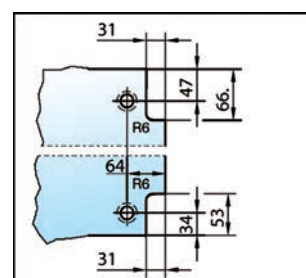
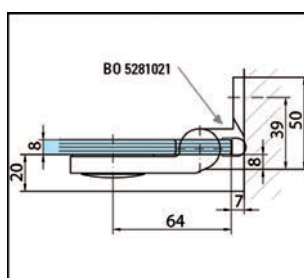

i Glass thickness 8 mm · Lifting height 5 mm · The deduction dimension of 13 mm has already been taken into account in the glass cut-out for inserting the water deflector BO 5213494. If another water deflector is used, the cut-out must be adapted accordingly.

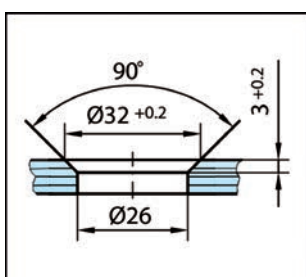

Shower Door Hinge Plan Artist glass/glass 180° DIN left



FINISH	ART. NO.
shiny chrome-plated	BO 5215607
stainless steel look	BO 5215609

max. door weight per pair	38 kg
max. door height	2100 mm
max. door width	900 mm
material	brass

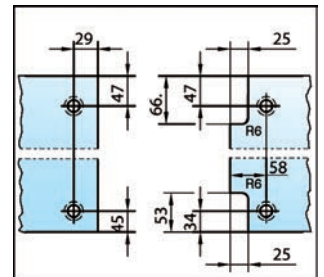
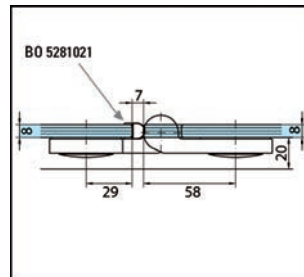

i Glass thickness 8 mm · Lifting height 5 mm · The deduction dimension of 13 mm has already been taken into account in the glass cut-out for inserting the water deflector BO 5213494. If another water deflector is used, the cut-out must be adapted accordingly.

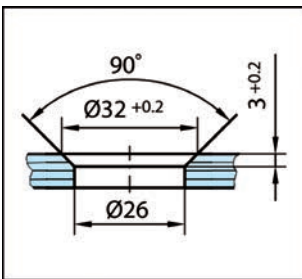

Shower Door Hinge Plan Artist glass/glass 180° DIN right



FINISH	ART. NO.
shiny chrome-plated	BO 5215611
stainless steel look	BO 5215613

max. door weight per pair	38 kg
max. door height	2100 mm
max. door width	900 mm
material	brass

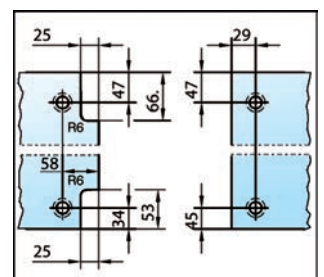
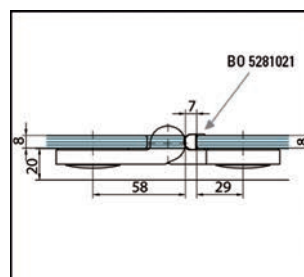

i Glass thickness 8 mm · Lifting height 5 mm · The deduction dimension of 13 mm has already been taken into account in the glass cut-out for inserting the water deflector BO 5213494. If another water deflector is used, the cut-out must be adapted accordingly.

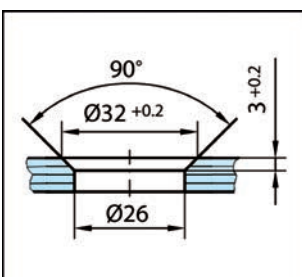

Shower Door Hinge Plan Artist glass/glass 135° DIN left



FINISH	ART. NO.
shiny chrome-plated	BO 5215614
stainless steel look	BO 5215616

max. door weight per pair	38 kg
max. door height	2100 mm
max. door width	900 mm
material	brass

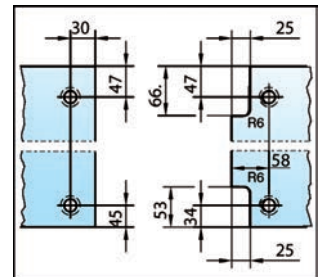
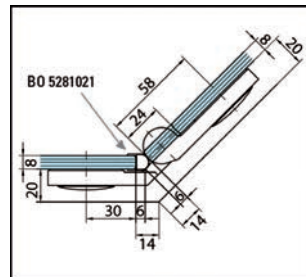

i Glass thickness 8 mm · Lifting height 5 mm · The deduction dimension of 13 mm has already been taken into account in the glass cut-out for inserting the water deflector BO 5213494. If another water deflector is used, the cut-out must be adapted accordingly.

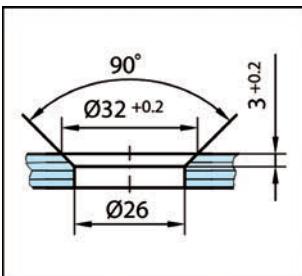

Shower Door Hinge Plan Artist glass/glass 135° DIN right



FINISH	ART. NO.
shiny chrome-plated	BO 5215617
stainless steel look	BO 5215619

max. door weight per pair	38 kg
max. door height	2100 mm
max. door width	900 mm
material	brass

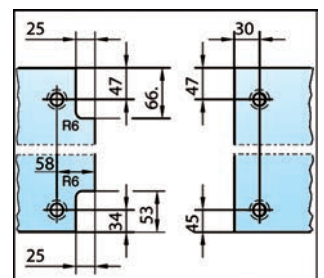
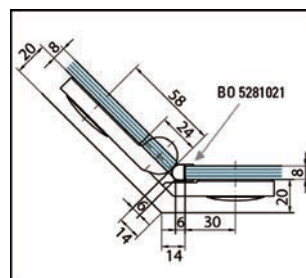

i Glass thickness 8 mm · Lifting height 5 mm · The deduction dimension of 13 mm has already been taken into account in the glass cut-out for inserting the water deflector BO 5213494. If another water deflector is used, the cut-out must be adapted accordingly.

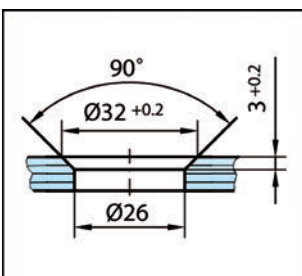

Shower Door Hinge Plan Artist glass/glass 90° DIN left



i Glass thickness 8 mm · Lifting height 5 mm · The deduction dimension of 13 mm has already been taken into account in the glass cut-out for inserting the water deflector BO 5213494. If another water deflector is used, the cut-out must be adapted accordingly.

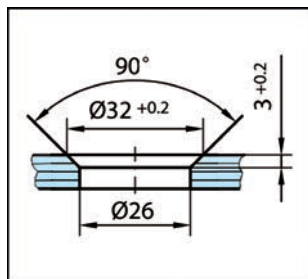

FINISH	ART. NO.
shiny chrome-plated	BO 5215621
stainless steel look	BO 5215623

max. door weight per pair	38 kg
max. door height	2100 mm
max. door width	900 mm
material	brass

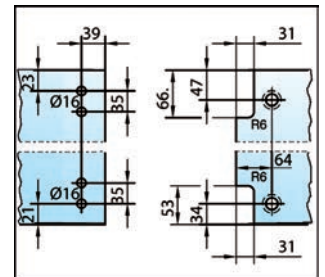
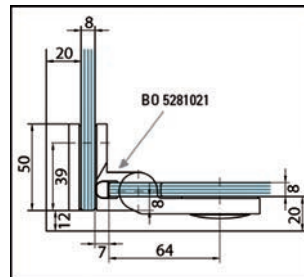

Shower Door Hinge Plan Artist glass/glass 90° DIN right



i Glass thickness 8 mm · Lifting height 5 mm · The deduction dimension of 13 mm has already been taken into account in the glass cut-out for inserting the water deflector BO 5213494. If another water deflector is used, the cut-out must be adapted accordingly.

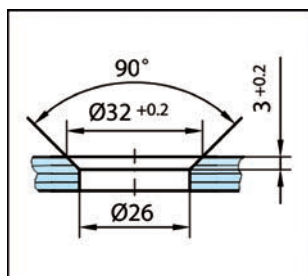

FINISH	ART. NO.
shiny chrome-plated	BO 5215624
stainless steel look	BO 5215626

max. door weight per pair	38 kg
max. door height	2100 mm
max. door width	900 mm
material	brass

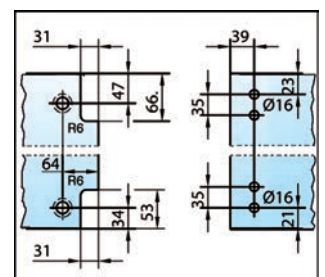
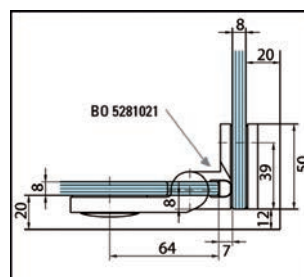

Corner Clamp Plan Artist glass/wall 90° Screw-on plate inwards

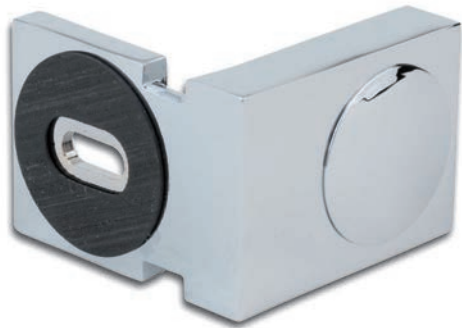

FINISH	ART. NO.
shiny chrome-plated	BO 5215581
stainless steel look	BO 5215583

max. door weight per pair	– kg
max. door height	– mm
max. door width	– mm
material	brass

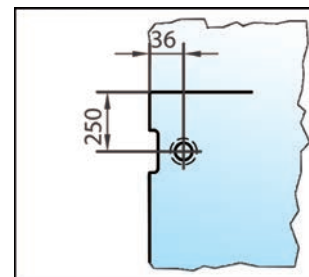
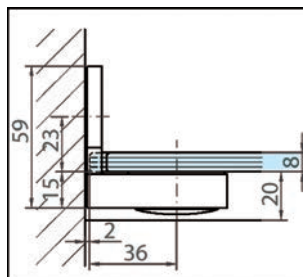

i Glass thickness 8 mm

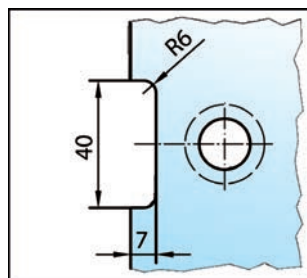
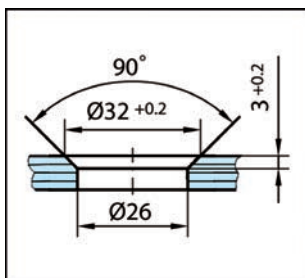

Corner Clamp Plan Artist glass/wall 90° Screw-on plate outwards

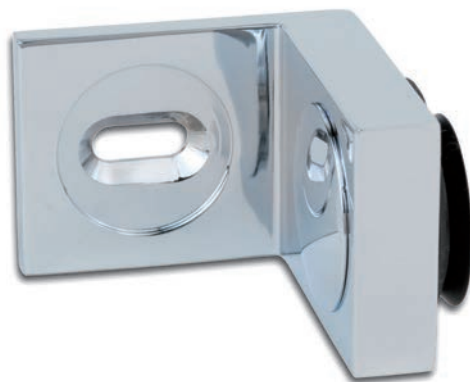

FINISH	ART. NO.
shiny chrome-plated	BO 5215584
stainless steel look	BO 5215586

max. door weight per pair	– kg
max. door height	– mm
max. door width	– mm
material	brass

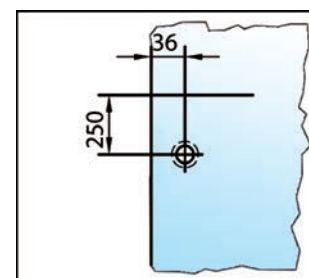
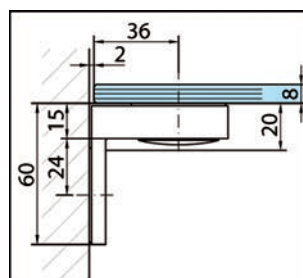

i Glass thickness 8 mm

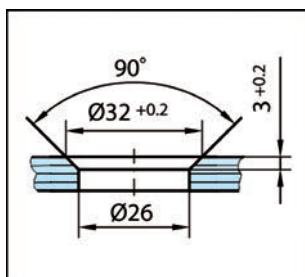

Corner Clamp Plan Artist glass/glass 90°



i Glass thickness 8 mm

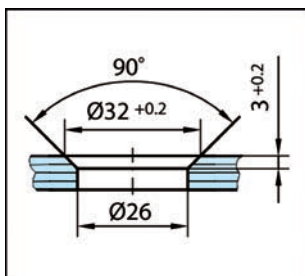

FINISH	ART. NO.
shiny chrome-plated	BO 5215587
stainless steel look	BO 5215589

max. door weight per pair	– kg
max. door height	– mm
max. door width	– mm
material	brass

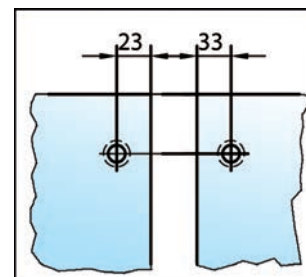
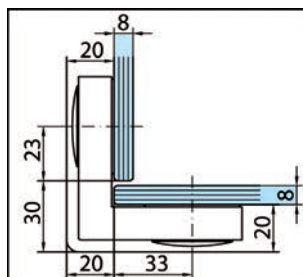

Corner Clamp Plan Artist glass/glass 135°



i Glass thickness 8 mm

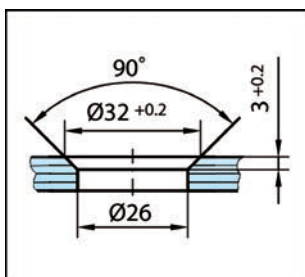

FINISH	ART. NO.
shiny chrome-plated	BO 5215591
stainless steel look	BO 5215593

max. door weight per pair	– kg
max. door height	– mm
max. door width	– mm
material	brass

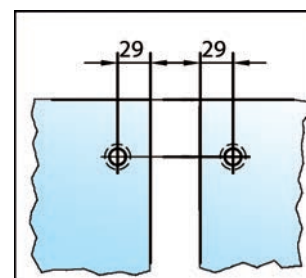
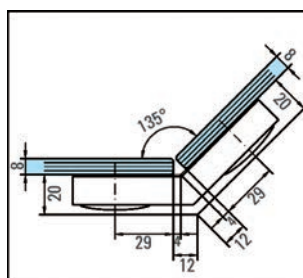

Aqua Shower Door Hinges

Bohle Aqua shower door fittings are the perfect alternative to all conventional shower door hinges. The full length aluminium profile system combines a simple and elegant design with all the technical standards of today: an infinitely adjustable zero position, a raising/lowering mechanism as well as a ± 6 mm vertical shim. In addition, the glass is bonded with silicone so no glass processing is required.



Shower Door Hinge Aqua glass/wall 90° for 6 mm



i Glass thickness 6 mm · Lifting height 5 mm · Hold position both sides at 90° · Profile length 2200 mm · Can be cut to the desired length · Please order two sets for double door applications. · Special profiles are also available as accessories for connecting to sidelights. · The deduction dimension of 13 mm has already been taken into account in the glass deduction for inserting the water deflector BO 5213494. If another water deflector is used, the deduction must be adapted accordingly.

INCLUDED IN DELIVERY:

1x	Wall profile
1x	Intermediate profile with brush strips
1x	Glass profile
1x	Accessory set incl. end stops

FINISH	ART. NO.
aluminium-coloured anodised E6/EV1	BO 5200405
polished anodised E3/EV1	BO 5200406
max. door weight per pair	35 kg
max. door height	2187 mm
max. door width	800 mm
material	aluminium

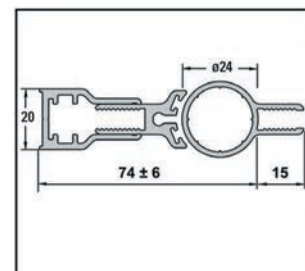
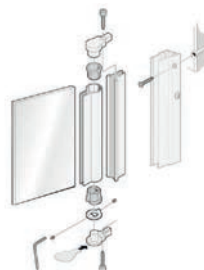

Shower Door Hinge Aqua glass/wall 90° for 8 mm



i Glass thickness 8 mm · Lifting height 5 mm · Hold position both sides at 90° · Profile length 2200 mm · Can be cut to the desired length · Please order two sets for double door applications. · Special profiles are also available as accessories for connecting to sidelights. · The deduction dimension of 13 mm has already been taken into account in the glass deduction for inserting the water deflector BO 5213494. If another water deflector is used, the deduction must be adapted accordingly.

INCLUDED IN DELIVERY:

1x	Wall profile
1x	Intermediate profile with brush strips
1x	Glass profile
1x	Accessory set incl. end stops

FINISH	ART. NO.
aluminium-coloured anodised E6/EV1	BO 5200407
polished anodised E3/EV1	BO 5200408
max. door weight per pair	35 kg
max. door height	2187 mm
max. door width	800 mm
material	aluminium

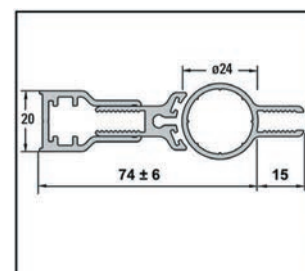

Aqua Adapter Profile for fixed sidelight for 6 mm



i Glass thickness 6 mm · Profile length 2200 mm · Can be cut to the desired length · Profiles for glass-floor connection of the sidelight are not included and must be ordered separately.

FINISH	ART. NO.
aluminium-coloured anodised E6/EV1	BO 5200409
polished anodised E3/EV1	BO 5200410
max. door weight per pair	– kg
max. door height	– mm
max. door width	– mm
material	aluminium

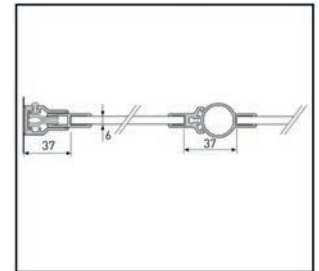
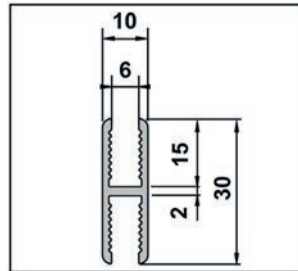

Aqua Adapter Profile for fixed sidelight for 8 mm



i Glass thickness 8 mm · Profile length 2200 mm · Can be cut to the desired length · Profiles for glass-floor connection of the sidelight are not included and must be ordered separately.

FINISH	ART. NO.
aluminium-coloured anodised E6/EV1	BO 5200416
polished anodised E3/EV1	BO 5200417
max. door weight per pair	– kg
max. door height	– mm
max. door width	– mm
material	aluminium

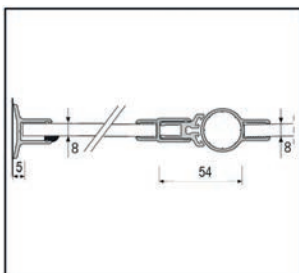
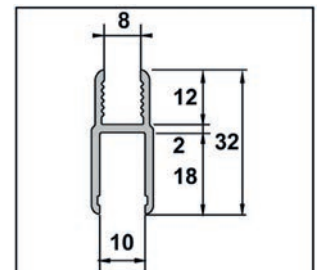
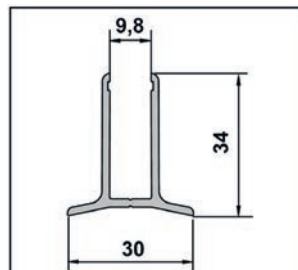

INCLUDED IN DELIVERY:

- 1x
- 1x
- 1x
- 1x

- 8 mm wall connection profile
- Rubber profile
- 8 mm adapter profile
- Installation kit

Art Shower Door Hinges

The Art shower door hinge is a classical design element making a particular statement with its rounded-off plate. It fits perfectly into any setting where a modern yet elegant design is required.



Shower Door Hinge Art glass/wall 90°, one side wall mounted



FINISH	ART. NO.
shiny chrome-plated	BK 8041031
max. door weight per pair	35 kg
max. door height	2000 mm
max. door width	750 mm
material	brass

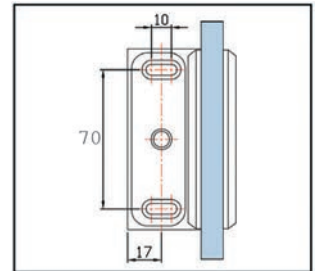
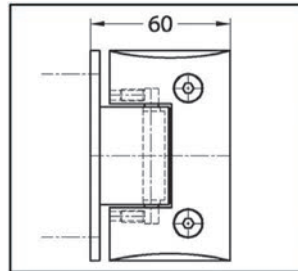

i Glass thickness 6, 8, 10 mm · Supplied without mounting hardware

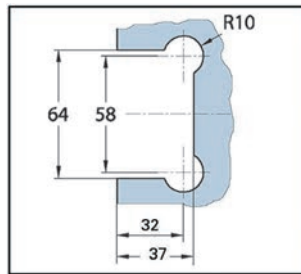
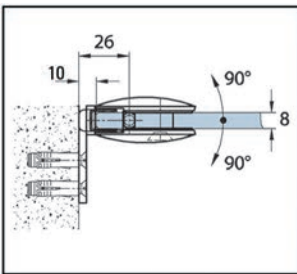

Shower Door Hinge Art glass/wall 90°, both sides wall mounted



FINISH	ART. NO.
shiny chrome-plated	BK 8042031
max. door weight per pair	35 kg
max. door height	2000 mm
max. door width	750 mm
material	brass

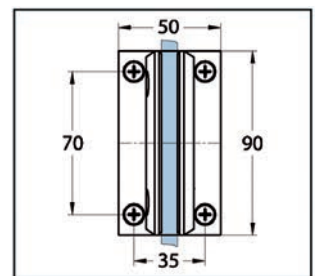
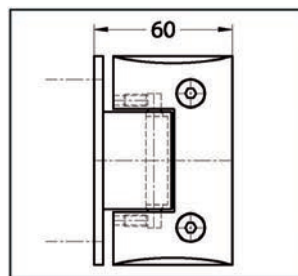

i Glass thickness 6, 8, 10 mm · Supplied without mounting hardware

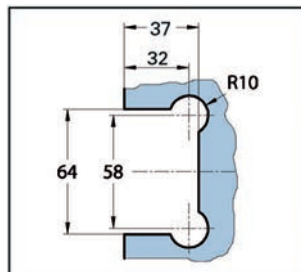
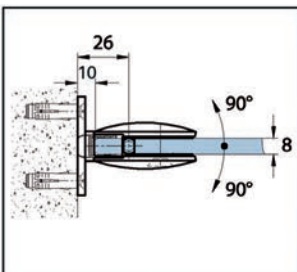

Shower Door Hinge Art glass/glass 180°



FINISH	ART. NO.
shiny chrome-plated	BK 8043031
max. door weight per pair	35 kg
max. door height	2000 mm
max. door width	750 mm
material	brass

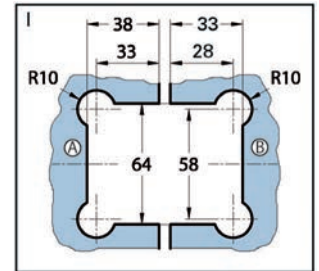
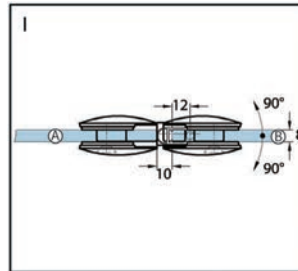

i Glass thickness 6, 8, 10 mm

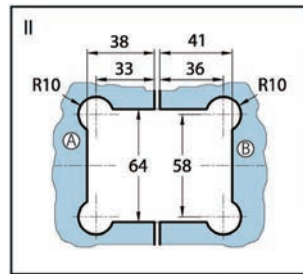
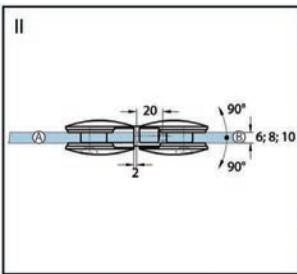

Corner Clamp Art glass / wall 90°



FINISH	ART. NO.
shiny chrome-plated	BK 8048131
max. door weight per pair	- kg
max. door height	- mm
max. door width	- mm
material	brass

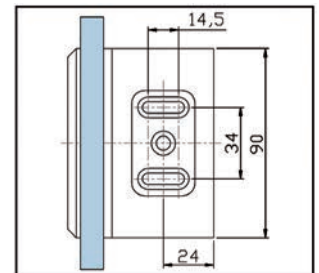
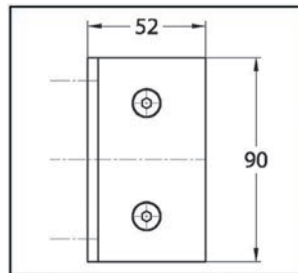

i Glass thickness 6, 8, 10 mm · Supplied without mounting hardware

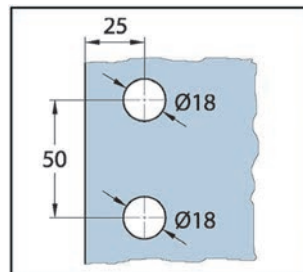
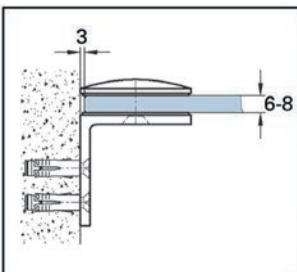

Corner Clamp Art glass/glass 90°



FINISH	ART. NO.
shiny chrome-plated	BK 8048331
max. door weight per pair	- kg
max. door height	- mm
max. door width	- mm
material	brass

i Glass thickness 6, 8, 10 mm

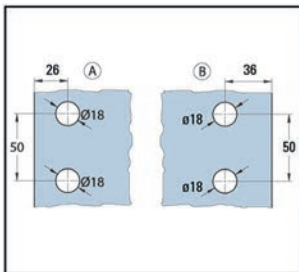
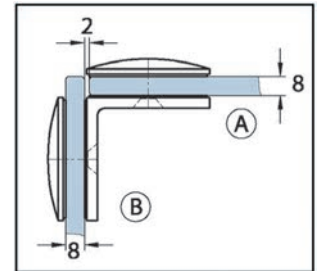
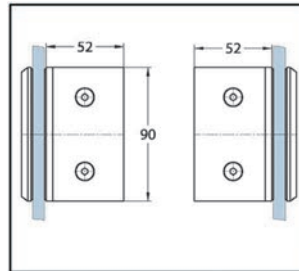

Easy Shower Door Hinges

Easy is a versatile shower door hinge – highly compact and unobtrusively designed. Due to its rounded-off edges, it adds a classy appearance to any bathroom without dominating the design.



Shower Door Hinge Easy glass/wall 90°, one side wall mounted



FINISH	ART. NO.
shiny chrome-plated	BK 8011031
max. door weight per pair	38 kg
max. door height	2250 mm
max. door width	900 mm
material	brass

i Glass thickness 8 mm · Self-closing from 15° · Continuously adjustable zero position · Supplied without mounting hardware

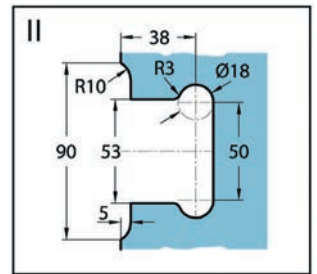
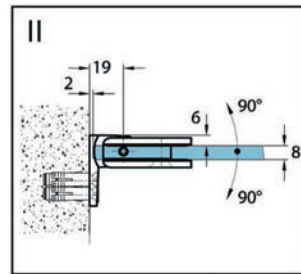
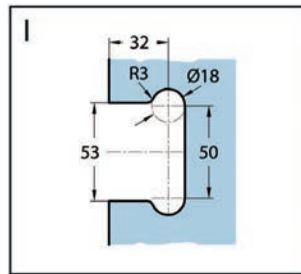
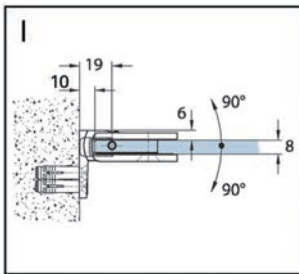
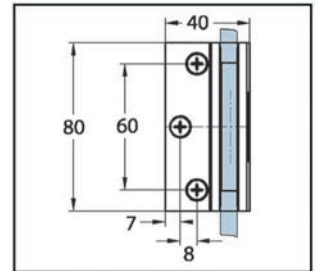
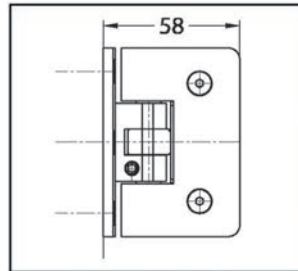

Shower Door Hinge Easy glass/glass 135°



FINISH	ART. NO.
shiny chrome-plated	BK 8017031
max. door weight per pair	38 kg
max. door height	2250 mm
max. door width	900 mm
material	brass

i Glass thickness 8 mm · Self-closing from 15° · Continuously adjustable zero position

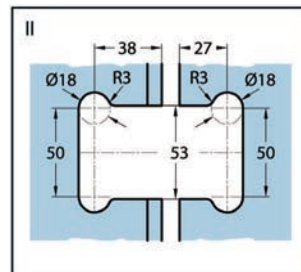
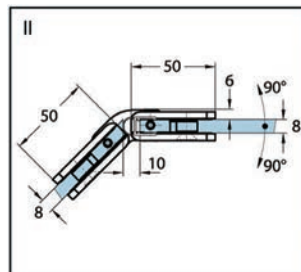
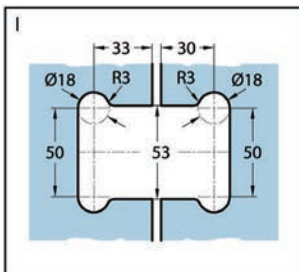
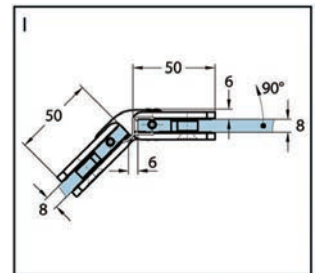
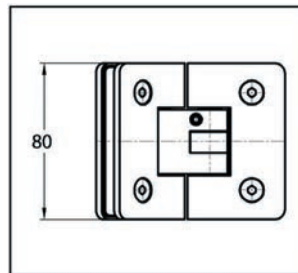

Shower Door Hinge Easy glass/glass 180°



i Glass thickness 8 mm · Self-closing from 15° · Continuously adjustable zero position

FINISH	ART. NO.
shiny chrome-plated	BK 8013031
max. door weight per pair	38 kg
max. door height	2250 mm
max. door width	900 mm
material	brass

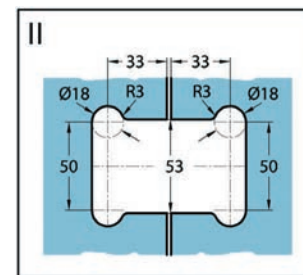
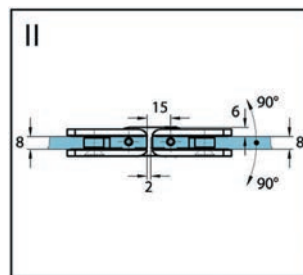
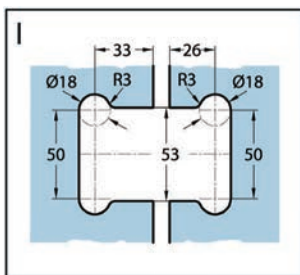
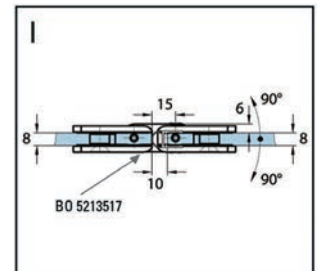
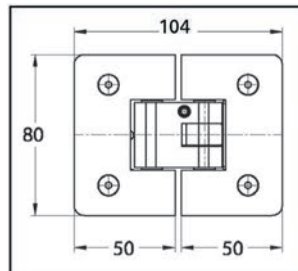

Corner Clamp Easy glass/wall 90°



i Glass thickness 8 mm · Supplied without mounting hardware

FINISH	ART. NO.
shiny chrome-plated	BK 8086131
max. door weight per pair	– kg
max. door height	– mm
max. door width	– mm
material	brass

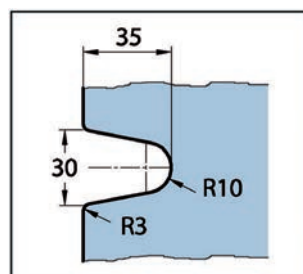
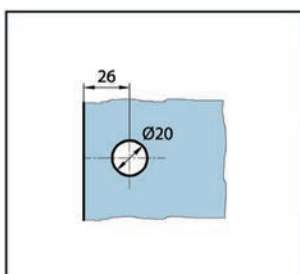
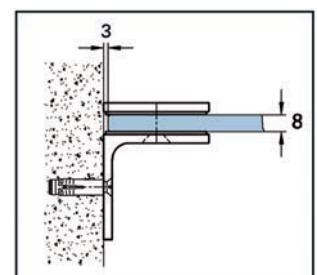
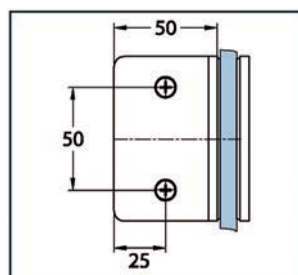

Corner Clamp Easy glass/glass 90°



FINISH	ART. NO.
shiny chrome-plated	BK 8086331
max. door weight per pair	- kg
max. door height	- mm
max. door width	- mm
material	brass

i Glass thickness 8 mm

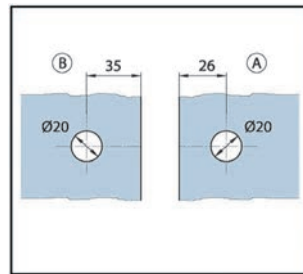
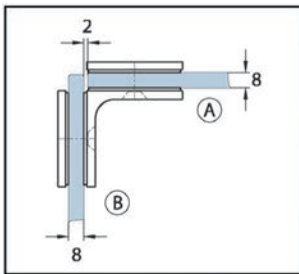
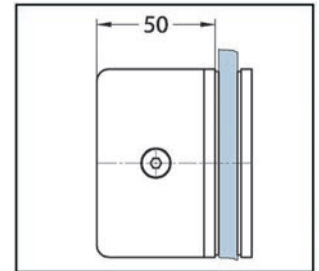
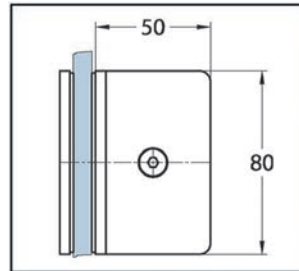

Sliding Door Systems For Showers

	Premium Slide SH	Aquant 40
		
Page	101	105
Recess application single door (max. mm)	1500	1550
Recess application double doors (max. mm)		2050
Corner application single door (max. mm)	1500 x 1100	1150 x 1150
Corner application double doors (max. mm)	1000 x 1000	1150 x 1150
Glass thickness tempered glass (mm)	8 / 10	8
max. door weight (kg)	60	40

Bohle Premium Slide SH Sliding Shower Door System

The Premium Slide SH sliding door system for all-glass showers stands out due to its unobtrusive elegance and supreme quality stainless steel. Whether in the private or commercial sector, the Premium Slide SH sliding door system lives up to demands for the highest quality. Bohle offers the following systems as a standard: double door corner application, single door corner application with sidelight, single door recess application.



Premium Slide SH Set, recess application, single door



i Glass thickness 8, 10 mm · With threshold · The U-profiles included in the delivery are made of aluminium.

FINISH	ART. NO.
brushed	BO 5214891
max. door weight	60 kg
max. door height	2200 mm
max. door width	775 mm
material	stainless steel

INCLUDED IN DELIVERY:

1x	Top track
2x	Sliding track holder
2x	Fixed sidelight point fixing
2x	Door point fixing
2x	Stoppers
1x	Bottom guide
2x	Aluminium U-profile
1x	Cover profile

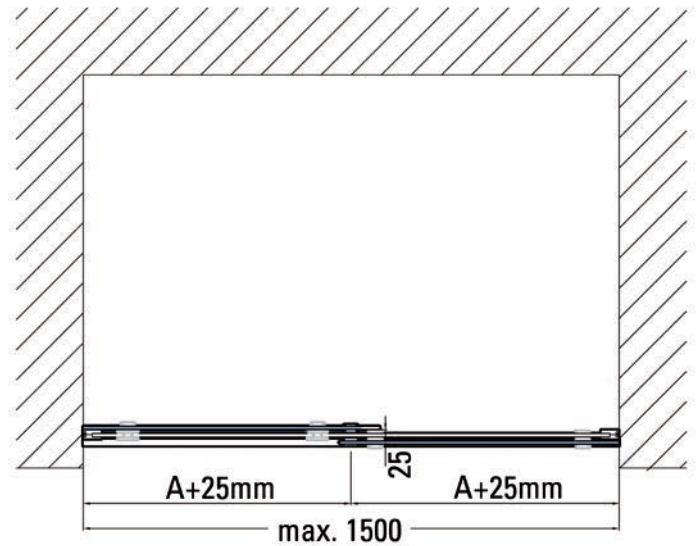
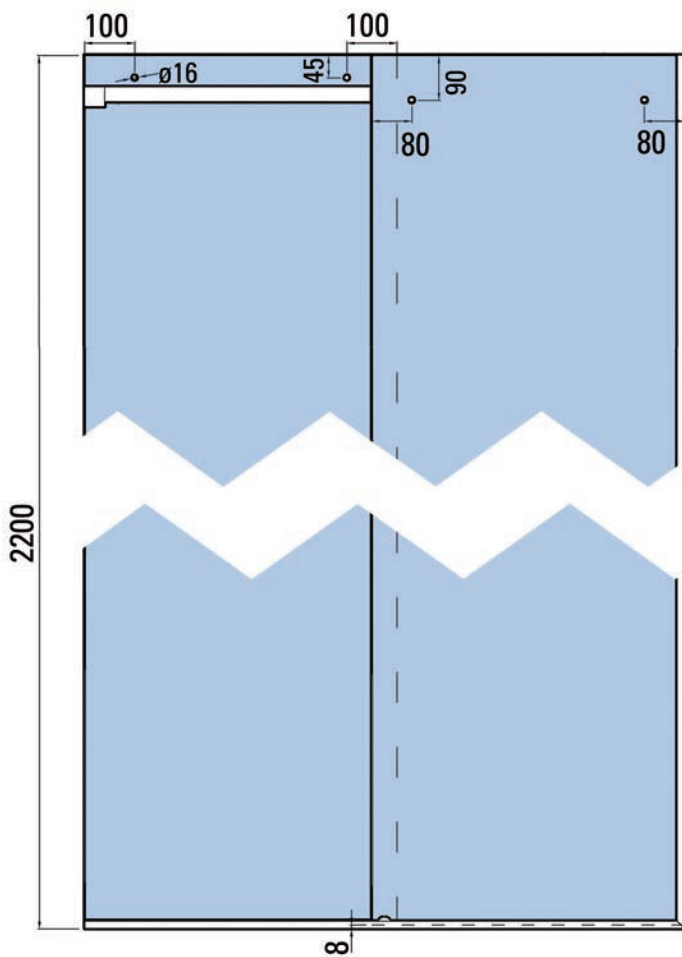

Premium Slide SH Set, corner application, single door, with sidelight



FINISH	ART. NO.
brushed	BO 5214892
max. door weight	60 kg
max. door height	2200 mm
max. door width	775 mm
material	stainless steel

INCLUDED IN DELIVERY:

1x	Top track
2x	Sliding track holder
2x	Fixed sidelight point fixing
2x	Door point fixing
2x	Stoppers
1x	Bottom guide
4x	Aluminium U-profile
1x	Cover profile

i Glass thickness 8, 10 mm · With threshold · The U-profiles included in the delivery are made of aluminium.

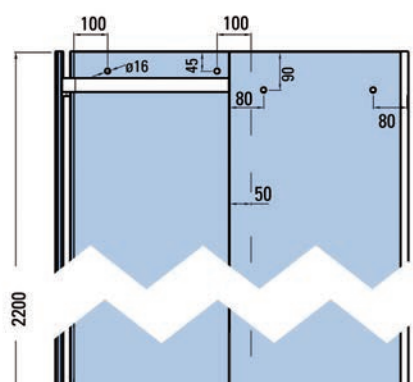
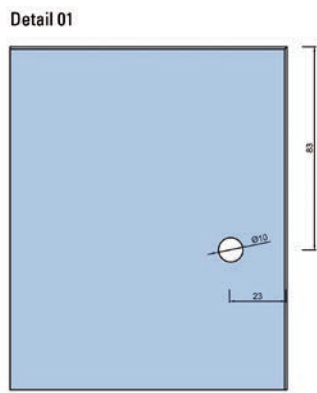
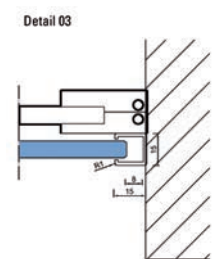
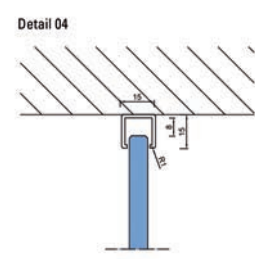
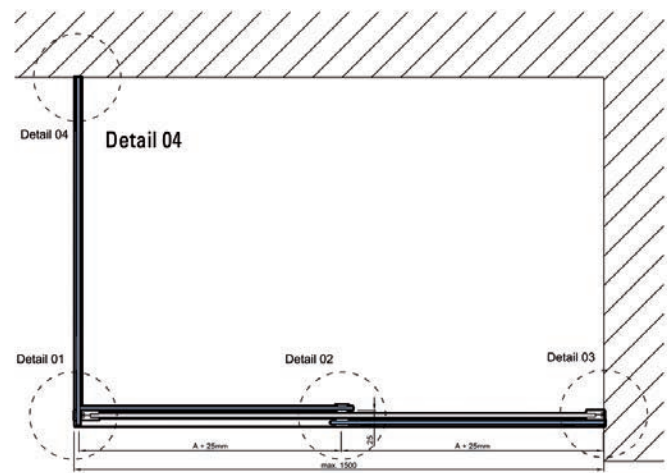
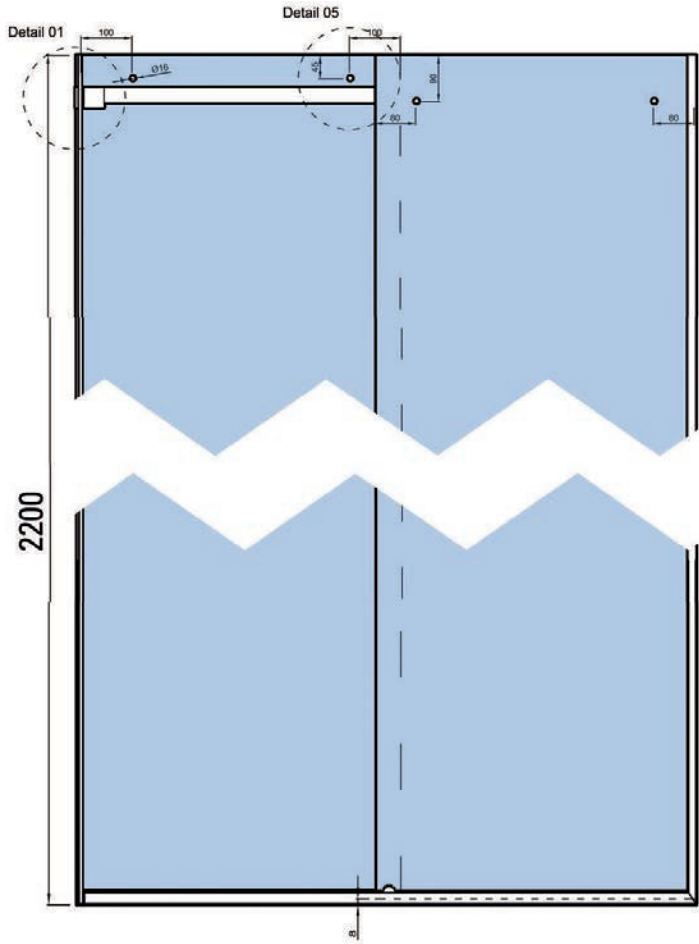

Willach Aquant 40 Sliding Door System

The innovative Aquant 40 glass sliding door fitting is a true miracle in the compact use of space. Despite a cushioning and retraction system on both sides of each sliding sash and completely covered roller assemblies, the slimline profile is only 50 mm high and 57 mm deep. Thanks to sturdy wall brackets and intelligently reinforced profiles, there is no need for ceiling suspension, even with corner and U-showers. As the roller runs above the centre of gravity of the fixed sash, no torque is applied to the track profile; this prevents twisting of the profile. Aquant 40 is suitable for corner, recess or U-showers. It can be used for showers with either one or two sliding sashes. Extension solutions to or on bathtubs are also possible.



Aquant 40 Set, corner application with damping mechanism, single door



MAX. DOOR WEIGHT · LENGTH	ART. NO.
40 kg · 1150 x 1150 mm	BO 5215086
max. door height	2500 mm
max. door width	– mm
material	aluminium
finish	polished

i Glass thickness 8 mm · min. door width 380 mm · Note: Please order bulb seal BO 5215190 or BO 5215191 separately.

INCLUDED IN DELIVERY:

2x	Profile set	Running track, cover, bedding profile for fixed glazing, water deflector
1x	Accessory kit door sash	2x carriages, 2x end stops, 1x damping mechanism for both sides, 2x bottom guides (left, right)
1x	Accessory installation	2x wall holders with screws/dowels, 1x mounting aid set, 1x mounting instructions
1x	Accessory kit corner bracket	1x corner piece, 1x stainless steel cover cap for end piece, 2x holders for end piece

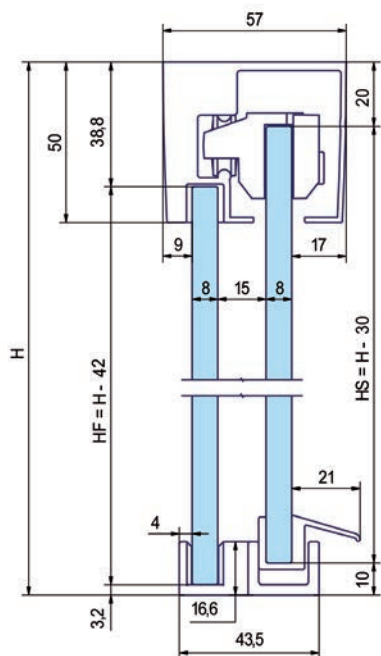

Aquant 40 Set, corner application with damping mechanism, double doors



MAX. DOOR WEIGHT · LENGTH	ART. NO.
20 kg · 950 x 950 mm	BO 5215087
40 kg · 1150 x 1150 mm	BO 5215088
max. door height	2500 mm
max. door width	– mm
material	aluminium
finish	polished

i Glass thickness 8 mm · min. door width 380 mm · Note: Please order bulb seal BO 5215190 or BO 5215191 separately.

INCLUDED IN DELIVERY:

2x	Profile set	Running track, cover, bedding profile for fixed glazing, water deflector
2x	Accessory kit door sash	2x carriages, 2x end stops, 1x damping mechanism for both sides, 2x bottom guides (left, right)
1x	Accessory installation	2x wall holders with screws/dowels, 1x mounting aid set, 1x mounting instructions
1x	Accessory kit corner bracket	1x corner piece, 1x stainless steel cover cap for end piece, 2x holders for end piece

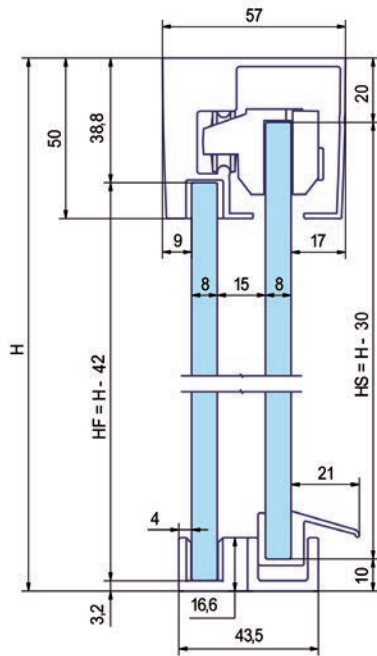

Aquant 40 Set, recess application with damping mechanism, single door



MAX. DOOR WEIGHT · LENGTH	ART. NO.
40 kg · 1150 mm	BO 5215089
40 kg · 1550 mm	BO 5215090
max. door height	2500 mm
max. door width	– mm
material	aluminium
Finish	polished

i Glass thickness 8 mm · min. door width 380 mm · Note: Please order bulb seal BO 5215190 or BO 5215191 separately.

INCLUDED IN DELIVERY:

1x	Profile set	Running track, cover, bedding profile for fixed glazing, water deflector
1x	Accessory kit door sash	Carriage, damping mechanism, bottom guide
1x	Accessory installation	2x wall holders with screws/dowels, 1x mounting aid set, 1x mounting instructions

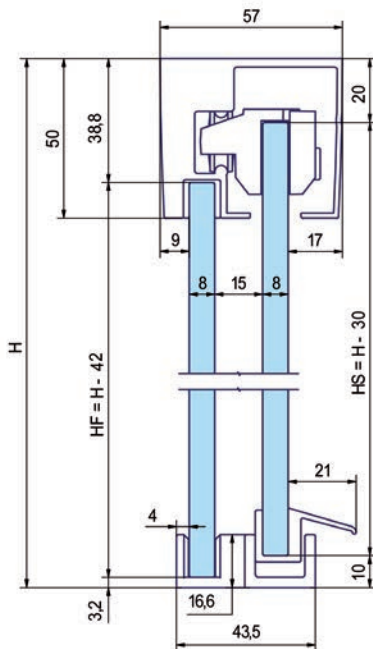

Aquant 40 Set, recess application with damping mechanism, double doors



MAX. DOOR WEIGHT · LENGTH	ART. NO.
20 kg · 2050 mm	BO 5215091
max. door height	2500 mm
max. door width	– mm
material	aluminium
Finish	polished

i Glass thickness 8 mm · min. door width 380 mm · Note: Please order bulb seal BO 5215190 or BO 5215191 separately.

INCLUDED IN DELIVERY:

1x	Profile set	Running track, cover, bedding profile for fixed glazing, water deflector
2x	Accessory kit door sash	Carriage, damping mechanism, bottom guide
1x	Accessory installation	2x wall holders with screws/dowels, 1x mounting aid set, 1x mounting instructions

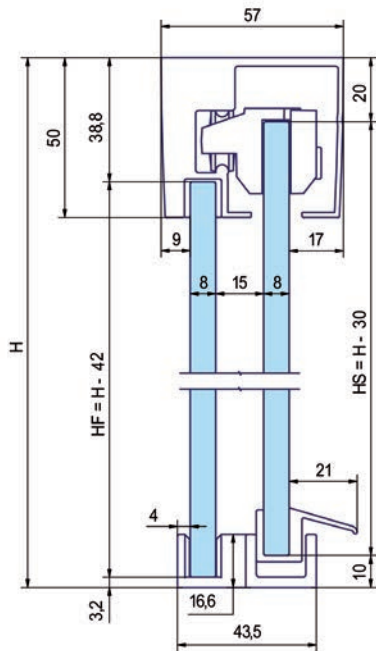

Aquant 40 Profile Set



LENGTH	ART. NO.
950 mm	BO 5215092
1150 mm	BO 5215093
1550 mm	BO 5215094
2050 mm	BO 5215095
Finish	polished
material	aluminium

i Glass thickness 8 mm · min. door width 380 mm · max. widths and heights: for recess showers with one door and a width of up to 1700 mm and with two doors and a width of up to 2000 mm · for corner and U-showers up to 1500 x 1500 mm, corner shower as one-sided application with two doors, also up to 2000 x 1200 mm

INCLUDED IN DELIVERY:

1x	Top track
1x	Cover
1x	Bedding profile for fixed glazing
1x	Water deflector

Aquant 40 Accessory Kit Door Sash

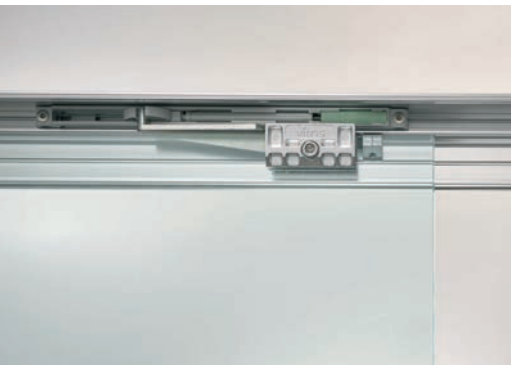

MAX. DOOR WEIGHT	ART. NO.
20 kg	BO 5215096
40 kg	BO 5215097

i Glass thickness 8 mm · min. door width 380 mm

INCLUDED IN DELIVERY:

2x	Carriages
2x	End stops
2x	Damping mechanism for both sides
1x	Bottom guide left
1x	Bottom guide right

Aquant 40 Accessory Installation



ART. NO.

BO 5215098

i Glass thickness 8 mm · min. door width 380 mm · Accessory set for running track installation

INCLUDED IN DELIVERY:

2x	Wall holder with screws/dowels
1x	Mounting aid set
1x	Mounting instructions

Aquant 40 Handle Ø 39 mm



FINISH

ART. NO.

brushed

BO 5215194

Depth

12 mm

material

stainless steel

i Glass thickness 8 mm

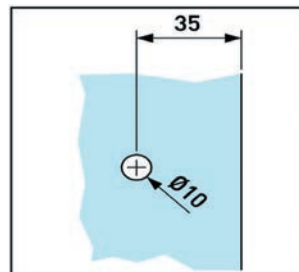

Aquant 40 Accessory Kit Corner Bracket



i Accessory set for connecting running tracks in recess applications

ART. NO.

BO 5215099

INCLUDED IN DELIVERY:

1x	Corner bracket
1x	Stainless steel cover cap for corner piece
2x	Support for corner piece

Aquant 40 bulb seal for recess shower application

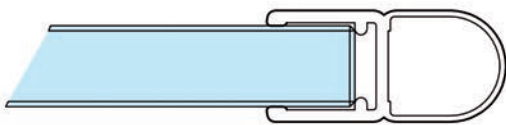

i Glass thickness 8 mm · The glass deduction dimension amounts to 14 mm.

LENGTH

ART. NO.

2000 mm

BO 5215190

2490 mm

BO 5215191

Aquant 40 vertical sealing strips

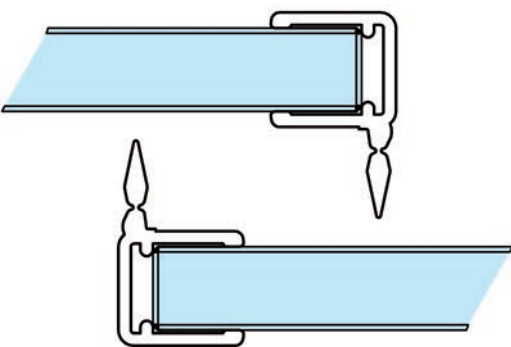

i Glass thickness 8 mm · sealing strips between fixed sidelight and sliding door · Packaging unit 1 pair

LENGTH

ART. NO.

2000 mm

BO 5215192

2490 mm

BO 5215193

Aquant 40 Clamp-on Profile for Wall Connection

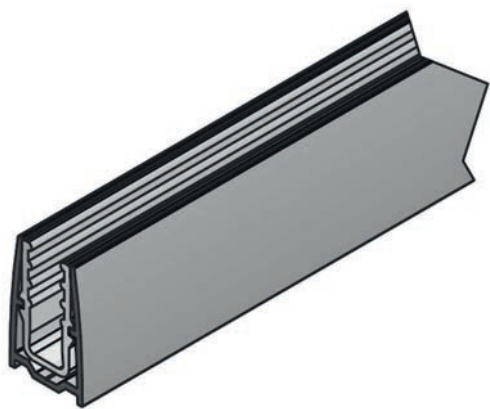

LENGTH	ART. NO.
2000 mm	BO 5215196
2490 mm	BO 5215197
Finish	polished

i Glass thickness 8 mm · Suitable for use with Aquant 40 sliding doors systems · incl. plastic insert, no sealing required

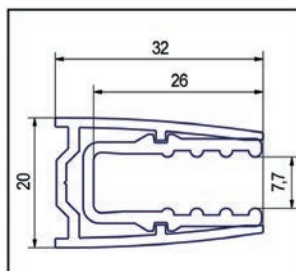

INCLUDED IN DELIVERY:

1x	Clamp-on profile
1x	Clamping insert

Sealing Strip with 90° Magnetic Profile for 6 - 8 mm

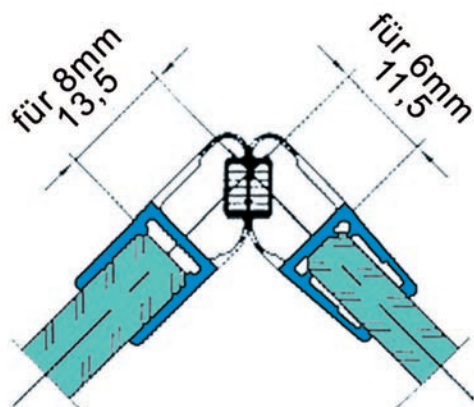

	ART. NO.
	BO 5213529
Length	2160 mm

i Glass thickness 6 - 8 mm · material PVC

Bohle Vigo Walk-In Shower

The Bohle Vigo Walk-In shower offers a clear design for the highest demands. Any long glass panels are simply placed in the retaining bars, which can be individually adjusted and fixed with hidden screws between the floor and ceiling. No reinforcement bar is required. Barrier-free – double-sided access suitable for wheelchair users. Ideal for rooms with angled surfaces and sophisticated open designs



Bohle Vigo Walk-In Set



SHAPE · FINISH	ART. NO.
square · brushed	BO 5215435
round · brushed	BO 5215437
round · polished	BO 5215438

Length	2800 mm
--------	---------

i Glass thickness 8, 10 mm · The profiles Can be cut to the desired lengths.

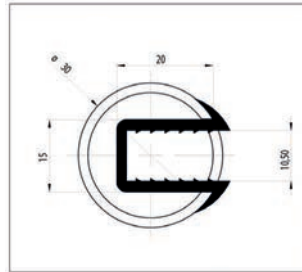
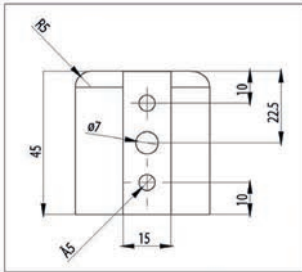
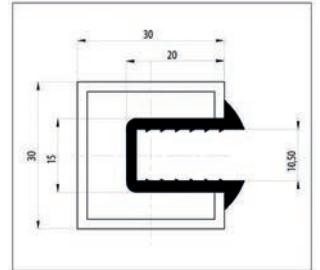
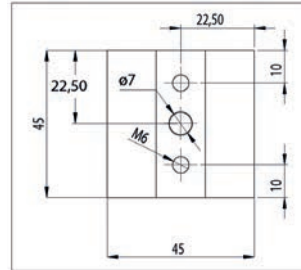

INCLUDED IN DELIVERY:

- 1x Stainless steel profile incl. mounting accessories
- 1x Rubber profile for 8 and 10 mm

Bohle Vigo Walk-In Bonding Plate



i Bonding plate for screwless floor mounting · with corrugated bottom surface for optimum distribution of the adhesive · only one stabilising bore hole in the floor needed

FINISH	ART. NO.
brushed	BO 5215700

material	stainless steel
Length	– mm

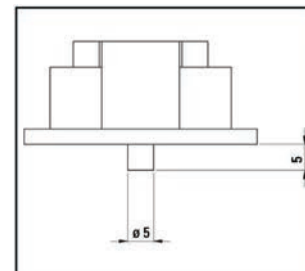
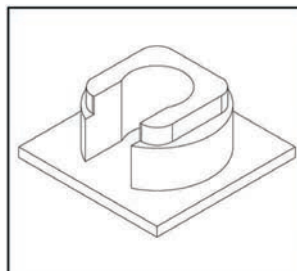

Bohle Vigo Walk-In Bonding Plate



i Bonding plate for screwless floor mounting · with corrugated bottom surface for optimum distribution of the adhesive · only one stabilising bore hole in the floor needed

FINISH	ART. NO.
brushed	BO 5215702
polished	BO 5215703

material	stainless steel
Length	– mm

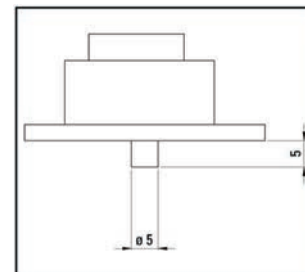
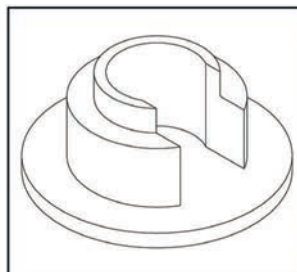

Reinforcement Bars

Bohle square

Timelessly modern. With Basic square, Bohle has achieved the perfect mix of form and function. The wide array of models enables almost any kind of customised construction project. Available in mirror polished and matt brushed stainless steel.



Bohle square 15 x 15 mm

Reinforcement Bar Set Bohle square 15x15 glass/wall 90°



i Glass thickness 6, 8, 10 mm

FINISH	ART. NO.
brushed	BO 5420240
polished	BO 5420241
Size	15 x 15 mm
Material	stainless steel
Length	963 mm

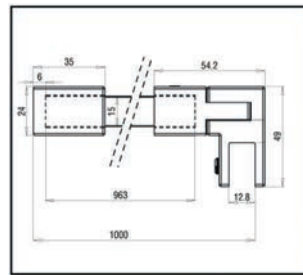
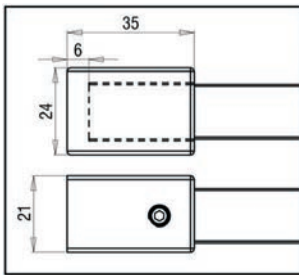
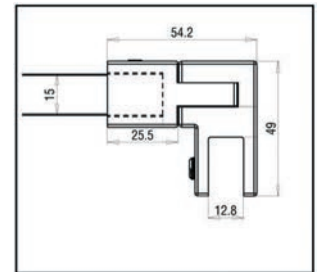
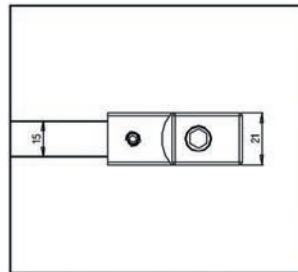

Reinforcement Bar Set Bohle square 15x15 glass/glass



FINISH	ART. NO.
polished	BO 5420237
Size	15 x 15 mm
Material	stainless steel
Length	953 mm

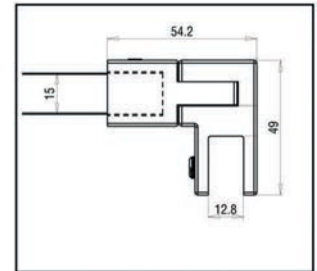
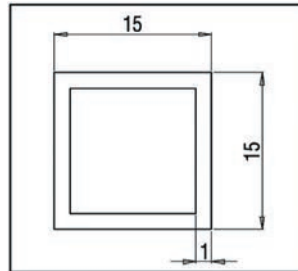

i Glass thickness 6, 8, 10 mm

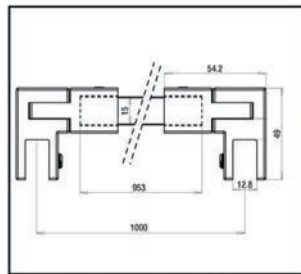
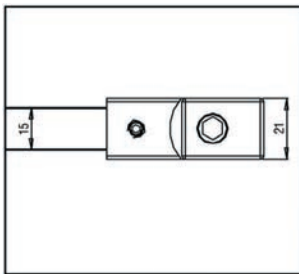

Reinforcement Bar Set Bohle square 15x15 glass/wall 45°



FINISH	ART. NO.
brushed	BO 5420238
polished	BO 5420239
Size	15 x 15 mm
Material	stainless steel
Length	451 mm

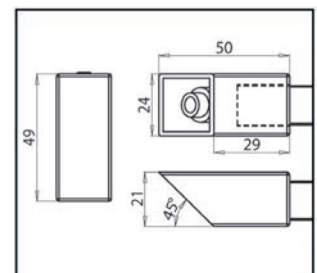
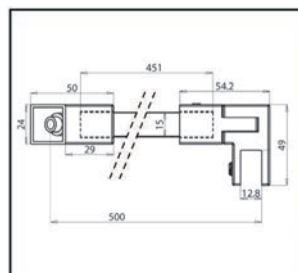

i Glass thickness 6, 8, 10 mm

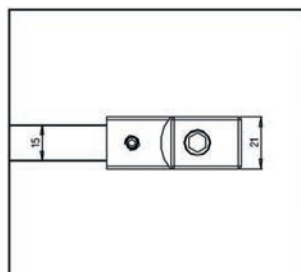
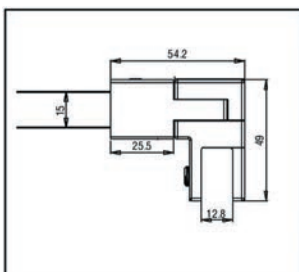

Wall Connector 90° Bohle square 15x15



FINISH	ART. NO.
brushed	BO 5420242
polished	BO 5420243
Size	15 x 15 mm
Material	stainless steel
Length	- mm

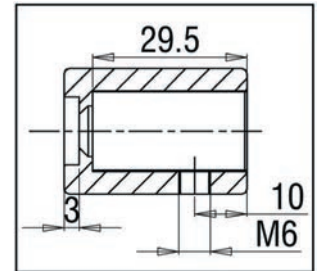
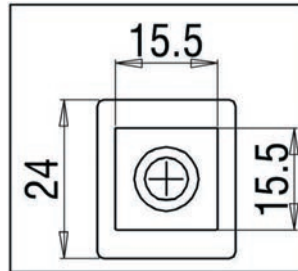

Wall Connector 45° Bohle square 15x15



FINISH	ART. NO.
brushed	BO 5420244
polished	BO 5420245
Size	15 x 15 mm
Material	stainless steel
Length	- mm

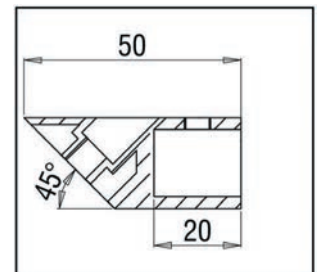
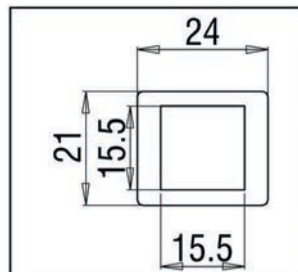

Wall connector adjustable 90° Bohle square 15x15

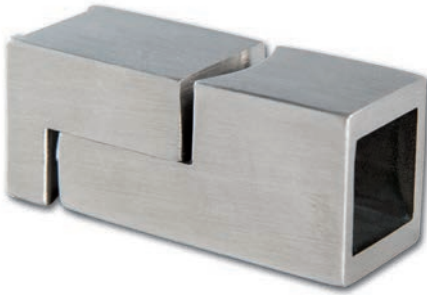

FINISH	ART. NO.
brushed	BO 5420246
polished	BO 5420247
Size	15 x 15 mm
Material	stainless steel
Length	- mm

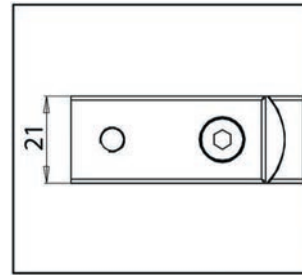
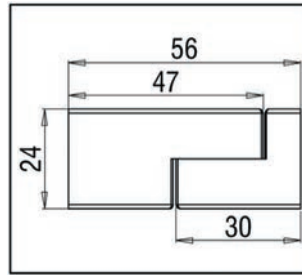
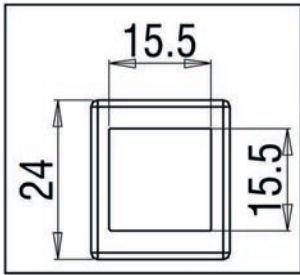

Connector 180° with Glass Connector Bohle square 15x15



FINISH	ART. NO.
brushed	BO 5420248
polished	BO 5420249
Size	15 x 15 mm
Material	stainless steel
Length	- mm

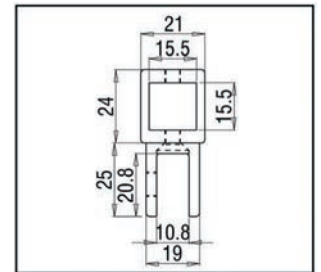
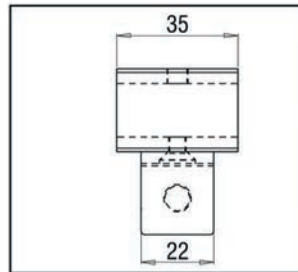

i Glass thickness 6, 8, 10 mm

Three-Point Connector Bohle square 15x15

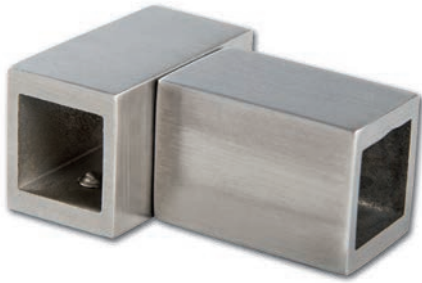

FINISH	ART. NO.
brushed	BO 5420250
polished	BO 5420251
Size	15 x 15 mm
Material	stainless steel
Length	- mm

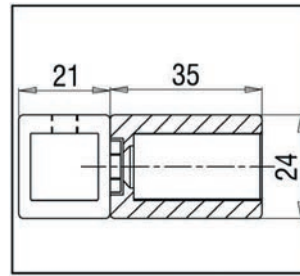
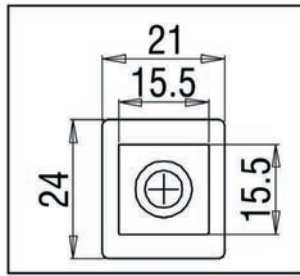
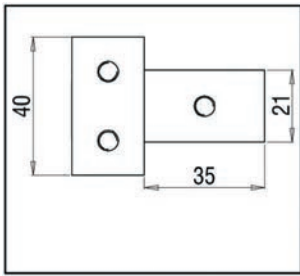

Corner Connector adjustable 90°-180° Bohle square 15x15



FINISH	ART. NO.
brushed	BO 5420252
polished	BO 5420253
Size	15 x 15 mm
Material	stainless steel
Length	- mm

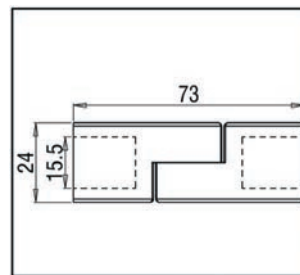
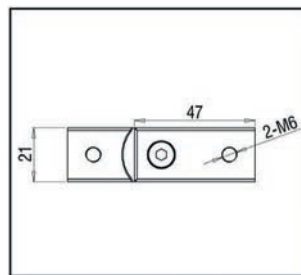
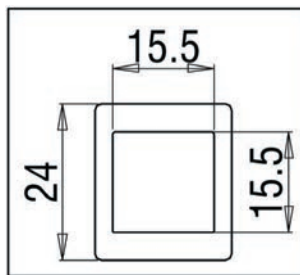

Corner Connector adjustable with Glass Connector Bohle square 15x15

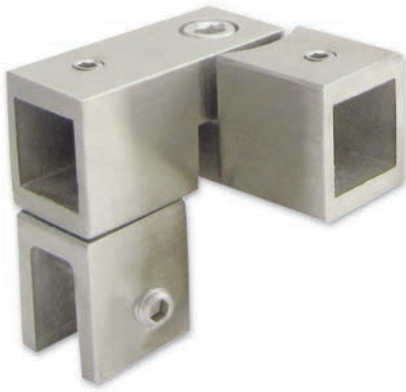

i Glass thickness 6, 8, 10 mm

FINISH	ART. NO.
brushed	BO 5420254
polished	BO 5420255
Size	15 x 15 mm
Material	stainless steel
Length	- mm

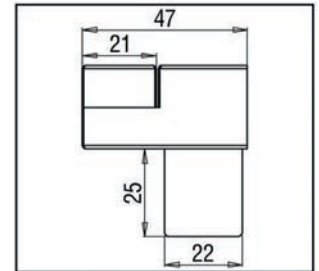
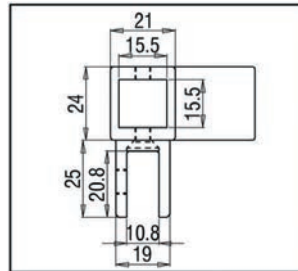

Glass Connector adjustable Bohle square 15x15



i Glass thickness 6, 8, 10 mm

FINISH	ART. NO.
brushed	BO 5420256
polished	BO 5420257
Size	15 x 15 mm
Material	stainless steel
Length	- mm

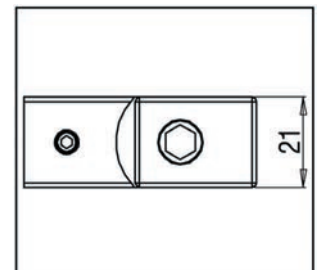
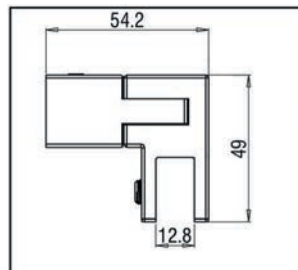

Reinforcement Bar Bohle square 15x15



FINISH · LENGTH	ART. NO.
brushed · 1000 mm	BO 5420258
polished · 1000 mm	BO 5420259
brushed · 2000 mm	BO 5420260
polished · 2000 mm	BO 5420261

Size	15 x 15 mm
Material	stainless steel

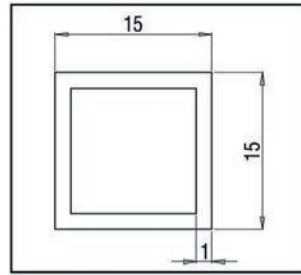

You will find further information (drawings, instruction manuals, etc.) in our Online Shop at www.bohle.com.

Bohle square 12 x 12 mm

Reinforcement Bar Set Bohle square 12x12 glass/wall 90°



i Bar can be trimmed to size · Adjustable wall connector · Concealed screws · Glass thickness 8, 10 mm

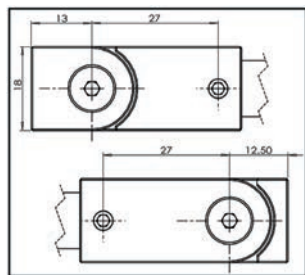

FINISH	ART. NO.
shiny chrome-plated	BO 5420262
Size	12 x 12 mm
Material	brass
Length	1210 mm

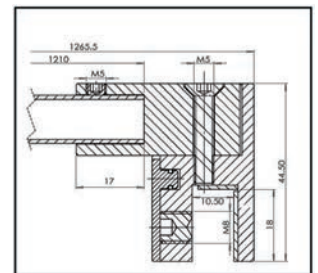
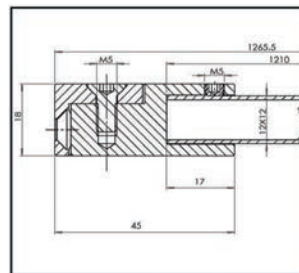

Through glass connector Bohle square 12x12

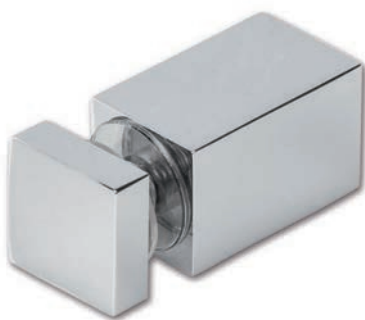

i Fixed with drill hole in glass · Glass thickness 8, 10, 12 mm

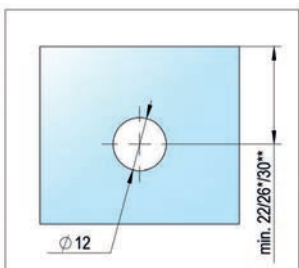

FINISH	ART. NO.
shiny chrome-plated	BO 5420065
Size	12 x 12 mm
Material	brass
Length	– mm

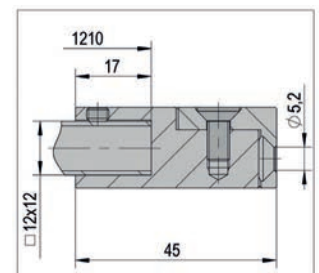
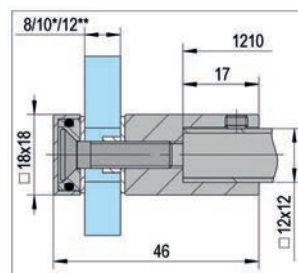

Bohle round

Easy to mount because reinforcement bars can be trimmed to any desired length. No cut-outs or drilled holes in the glass required. Glass holders are infinitely adjustable.

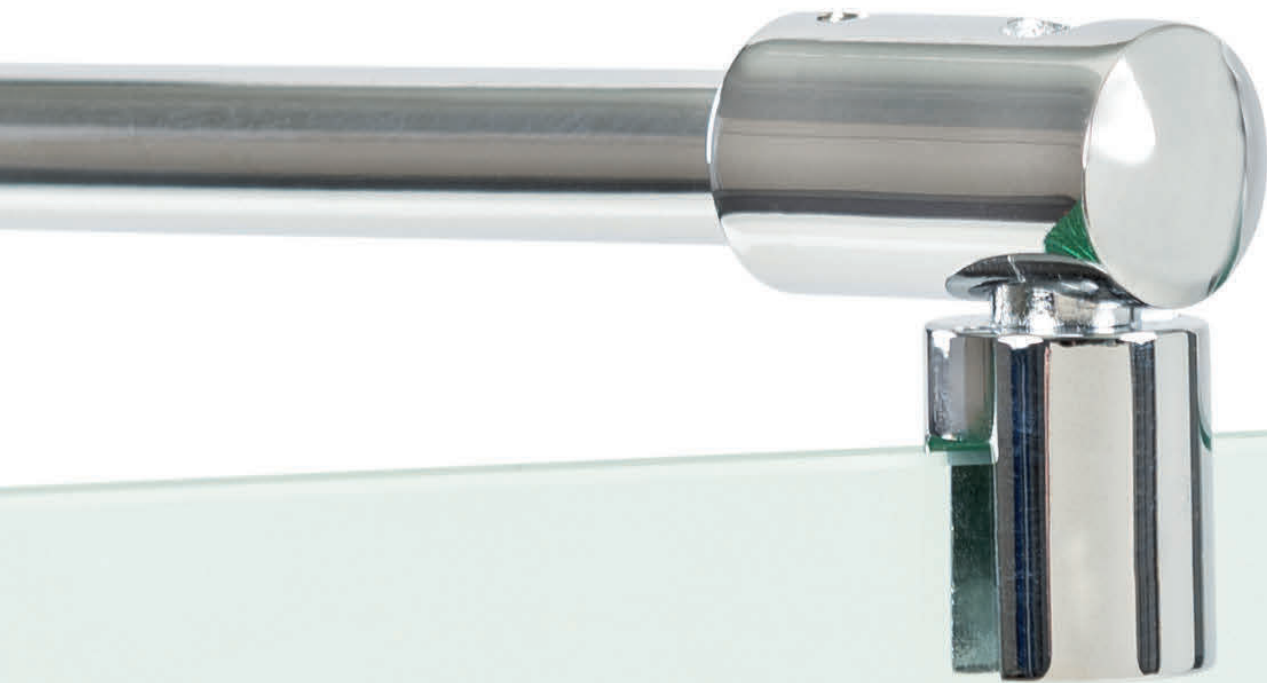

Bohle round \varnothing 12 mm

Reinforcement Bar Set Bohle round \varnothing 12 glass/wall 90°



i Bar can be trimmed to size · Adjustable wall connector · Glass thickness 8, 10 mm

FINISH	ART. NO.
shiny chrome-plated	BO 5420065
Size	\varnothing 12 mm
Material	brass
Length	1210 mm

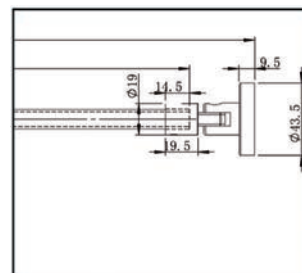
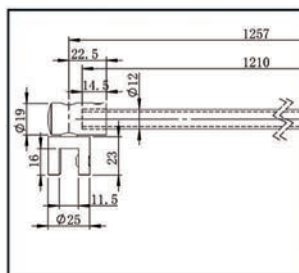

Wall Connector 90° Bohle round \varnothing 12



i Suitable for reinforcement Bar BO 5420065

FINISH	ART. NO.
shiny chrome-plated	BO 5420064
Size	\varnothing 12 mm
Material	brass
Length	- mm

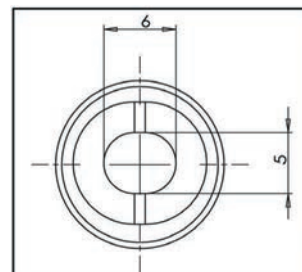
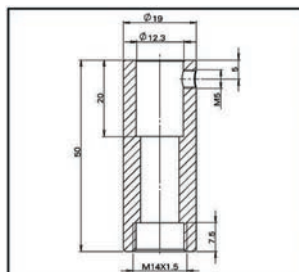

Through glass connector Bohle round $\varnothing 12$



FINISH	ART. NO.
shiny chrome-plated	BO 5420065

Size	$\varnothing 12$ mm
Material	brass
Length	– mm

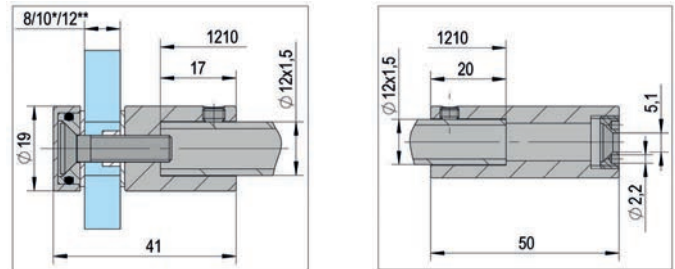

i Fixed with drill hole in glass · Glass thickness 8, 10, 12 mm

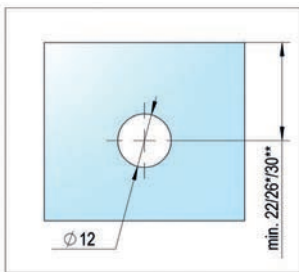

You will find further information (drawings, instruction manuals, etc.) in our Online Shop at www.bohle.com.

Bohle round \varnothing 19 mm

Reinforcement Bar Bohle round \varnothing 19



FINISH · LENGTH	ART. NO.
shiny chrome-plated · 1000 mm	BO 5420101
stainless steel look · 1000 mm	BO 5420003
shiny chrome-plated · 1300 mm	BO 5420105
stainless steel look · 1300 mm	BO 5420007
shiny chrome-plated · 1800 mm	BO 5420107

Size	\varnothing 19 mm
Material	brass

i Without fixings

Glass Connector adjustable Bohle round \varnothing 19 for 6 - 8 mm



FINISH	ART. NO.
shiny chrome-plated	BO 5420021
stainless steel look	BO 5420023

Size	\varnothing 19 mm
Material	brass
Length	– mm

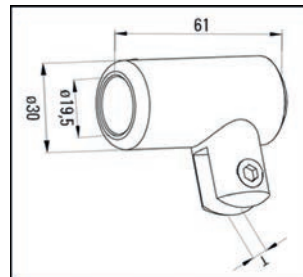

i Glass thickness 6, 8 mm

Glass Connector adjustable Bohle round $\varnothing 19$ for 10 - 12 mm



FINISH	ART. NO.
shiny chrome-plated	BO 5420025
stainless steel look	BO 5420027
Size	$\varnothing 19$ mm
Material	brass
Length	- mm

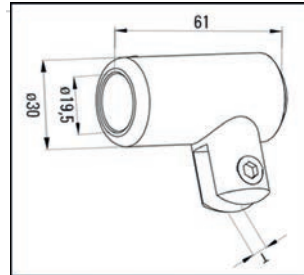

i Glass thickness 10, 12 mm

Glass Connector adjustable Bohle round $\varnothing 19$



FINISH	ART. NO.
shiny chrome-plated	BO 5420121
Size	$\varnothing 19$ mm
Material	brass
Length	- mm

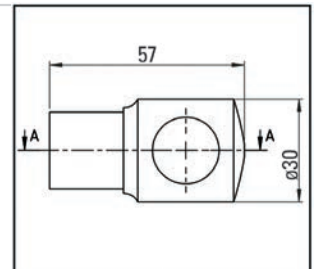
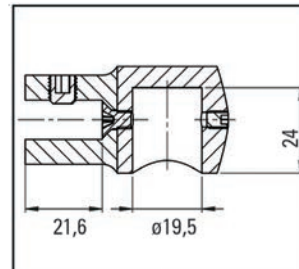

i Glass thickness 6, 8, 10 mm

Wall Connector 90° Bohle round $\varnothing 19$



FINISH	ART. NO.
shiny chrome-plated	BO 5420061
stainless steel look	BO 5420063
Size	$\varnothing 19$ mm
Material	brass
Length	- mm

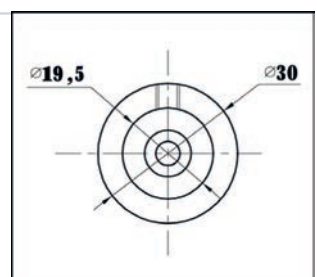
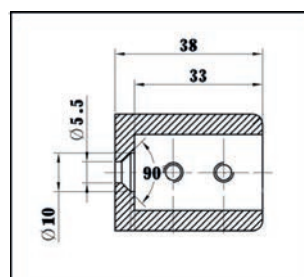

Wall Connector 90° Bohle round ø19



FINISH	ART. NO.
shiny chrome-plated	BO 5420011
Size	ø 19 mm
Material	brass
Length	- mm

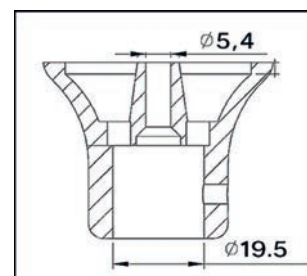
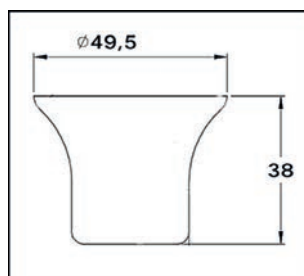

Wall Connector 90° Bohle round ø19



FINISH	ART. NO.
shiny chrome-plated	BO 5420111
Size	ø 19 mm
Material	brass
Length	- mm

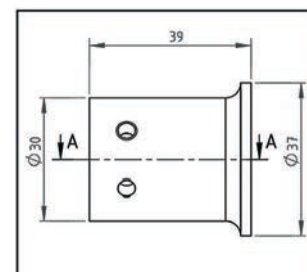
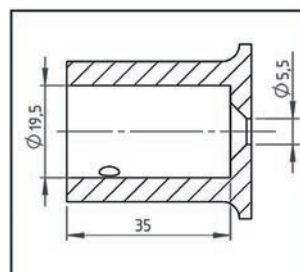

Wall Connector 45° Bohle round ø19



FINISH	ART. NO.
shiny chrome-plated	BO 5420115
Size	ø 19 mm
Material	brass
Length	- mm

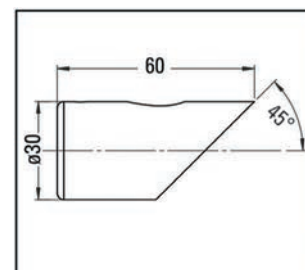
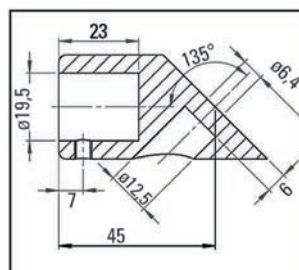

Connector 180° with Glass Connector Bohle round ø19



FINISH	ART. NO.
shiny chrome-plated	BO 5420135
Size	ø 19 mm
Material	brass
Length	- mm

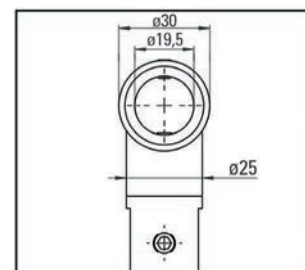
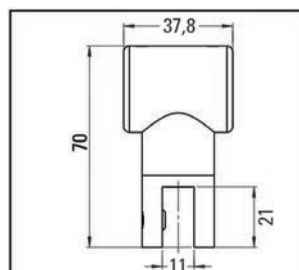

i Glass thickness 6, 8, 10 mm

Corner Connector 135° with Glass Connector Bohle round $\varnothing 19$



FINISH	ART. NO.
shiny chrome-plated	BO 5420141
Size	$\varnothing 19$ mm
Material	brass
Length	- mm

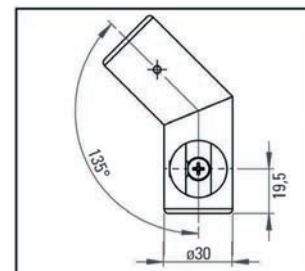
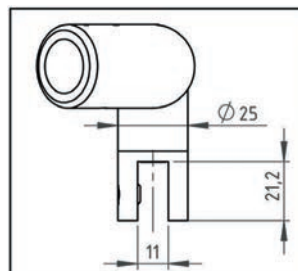

i Glass thickness 6, 8, 10 mm · Can be used on left or right side

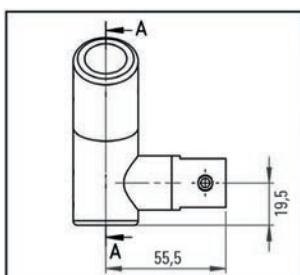

Corner Connector 90° with Glass Connector Bohle round $\varnothing 19$



FINISH	ART. NO.
shiny chrome-plated	BO 5420145
Size	$\varnothing 19$ mm
Material	brass
Length	- mm

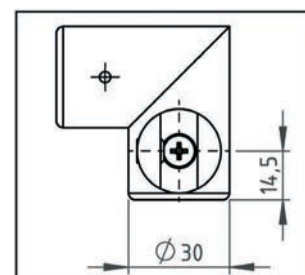
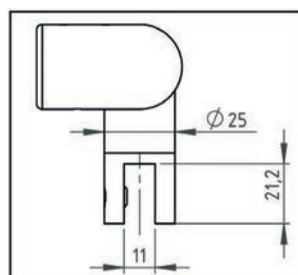

i Glass thickness 6, 8, 10 mm · Can be used on left or right side

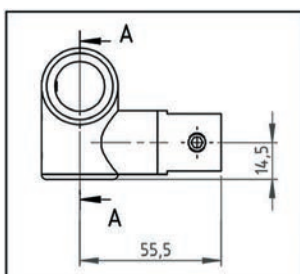

Three-Point Connector with Glass Connector Bohle round $\varnothing 19$



FINISH	ART. NO.
shiny chrome-plated	BO 5420151
Size	$\varnothing 19$ mm
Material	brass
Length	- mm

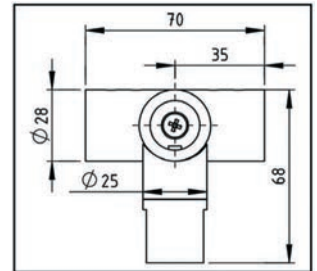
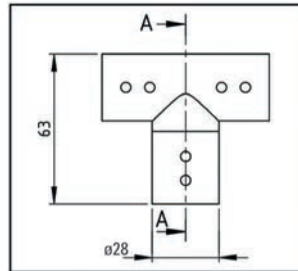

i Glass thickness 6, 8, 10 mm

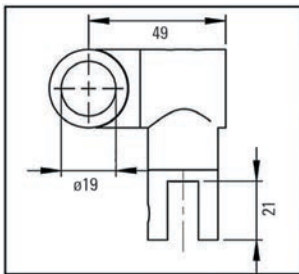

Three-Point Connector Bohle round $\varnothing 19$

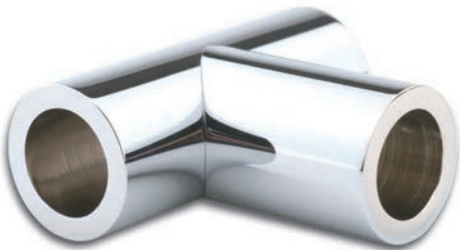

FINISH	ART. NO.
shiny chrome-plated	BO 5420155
stainless steel look	BO 5420156
Size	$\varnothing 19$ mm
Material	brass
Length	- mm

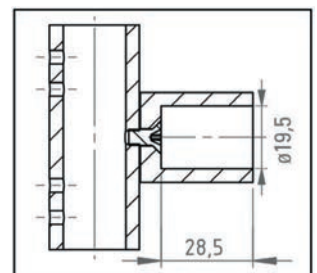
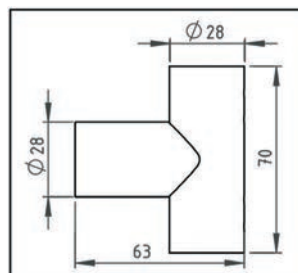

Connector adjustable 90°-180° Bohle round ø19



FINISH	ART. NO.
shiny chrome-plated	BO 5420161
Size	ø 19 mm
Material	brass
Length	- mm

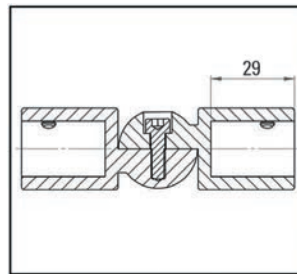
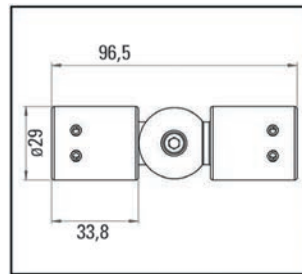
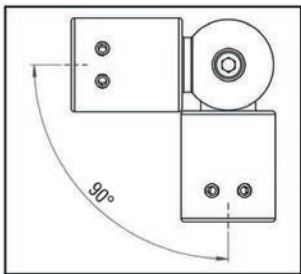

Connector with Glass Connector Bohle round ø19



FINISH	ART. NO.
shiny chrome-plated	BO 5420125
Size	ø 19 mm
Material	brass
Length	- mm

i Glass thickness 6, 8, 10 mm

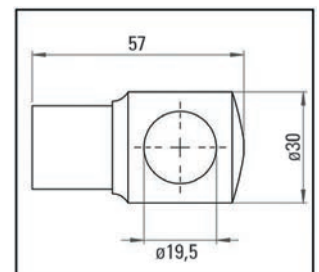
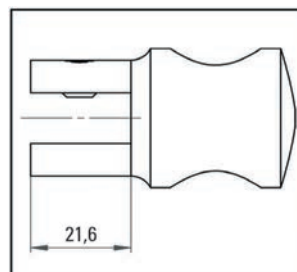

Corner Connector 90° Bohle round ø19

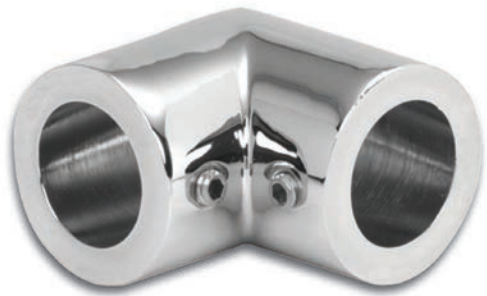

FINISH	ART. NO.
shiny chrome-plated	BO 5420041
Size	ø 19 mm
Material	brass
Length	- mm

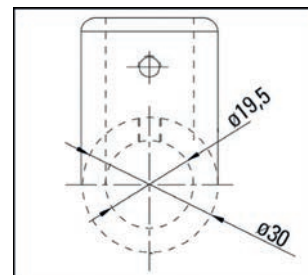
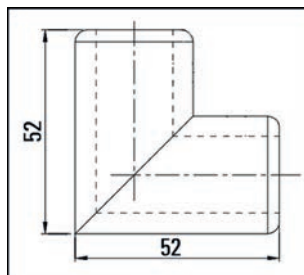

Connector 180° Bohle round ø19 for 6 - 8 mm



FINISH	ART. NO.
shiny chrome-plated	BO 5420051
Size	ø 19 mm
Material	brass
Length	- mm

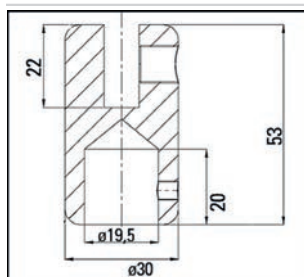

i Glass thickness 6, 8 mm · Max. advisory distance 300 mm from ceiling to glass

Connector 180° Bohle round ø19 for 10 - 12 mm



FINISH	ART. NO.
shiny chrome-plated	BO 5420055
Size	ø 19 mm
Material	brass
Length	- mm

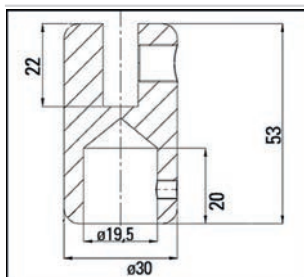

i Glass thickness 10, 12 mm · Max. advisory distance 300 mm from ceiling to glass

Bohle Telescopic round \varnothing 19 mm

Telescopic Reinforcement Bar Set Bohle round \varnothing 19 glass/wall 90°



FINISH · LENGTH	ART. NO.
shiny chrome-plated · 820 - 1000 mm	BO 5420211
shiny chrome-plated · 1000 - 1150 mm	BO 5420215

Size	\varnothing 19 mm
Material	brass

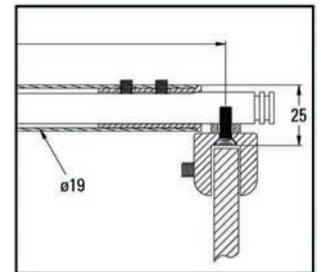
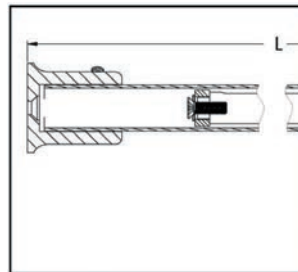

i Length adjustable · Glass thickness 6, 8, 10 mm · Bar can be trimmed to size

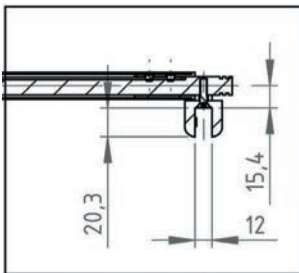

Telescopic Reinforcement Bar Set Bohle round $\varnothing 19$ glass/wall 45°



FINISH · LENGTH	ART. NO.
shiny chrome-plated · 240 - 400 mm	BO 5420221
shiny chrome-plated · 550 - 700 mm	BO 5420225
Size	$\varnothing 19$ mm
Material	brass

i Length adjustable · Glass thickness 6, 8, 10 mm · Bar can be trimmed to size

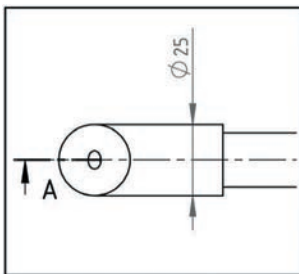
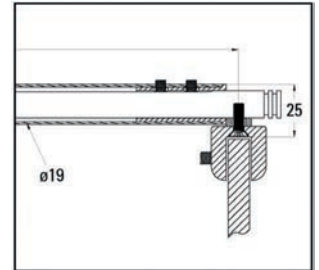
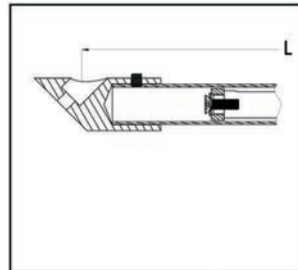

Telescopic Reinforcement Bar Set Bohle round $\varnothing 19$ glass/glass



FINISH	ART. NO.
shiny chrome-plated	BO 5420231
Size	$\varnothing 19$ mm
Material	brass
Length	750 - 1050 mm

i Length adjustable · Glass thickness 6, 8, 10 mm

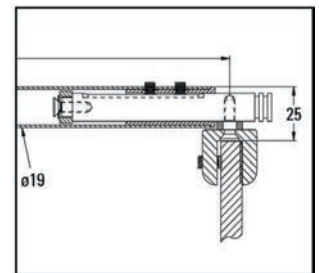
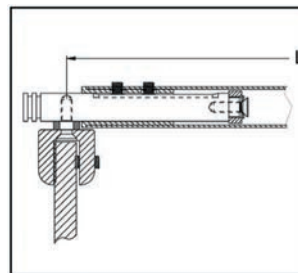

You will find further information (drawings, instruction manuals, etc.) in our Online Shop at www.bohle.com.

Shower door handles and knobs

Our wide range of knobs, handles and towel holders helps individualise your shower cubicle to your personal bathroom concept. Great value is attached to the choice of different materials, finishes, applications and shapes available.



Shower Door Handle self-adhesive, single sided



FINISH · DEPTH	ART. NO.
brushed · (H) 17 mm	BO 5113720
polished · (H) 17 mm	BO 5113721
polished · (H) 8 mm	BO 5113723

Material	stainless steel
Width	(B) 12 mm
Height	(L) 150 mm

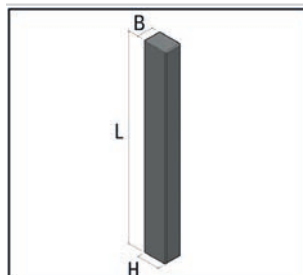

Shower Doorknob, both sides



FINISH	ART. NO.
shiny chrome-plated	BO 5213725

Material	brass
Width	ø30 mm
Height	– mm
Depth	50 mm

i Glass thickness tempered glass 6, 8, 10 mm · Drill hole in glass ø10 mm

Shower Doorknob, both sides



FINISH · MATERIAL	ART. NO.
shiny chrome-plated · brass	BO 5213705
stainless steel look · brass	BO 5213706
shiny chrome-plated · aluminium	BO 5213708
stainless steel look · aluminium	BO 5213709

Width	ø32 mm
Height	– mm
Depth	30 mm

i Glass thickness tempered glass 6, 8, 10 mm · Drill hole in glass ø10 mm

Shower Doorknob, both sides



FINISH	ART. NO.
shiny chrome-plated	BO 5213715
stainless steel look	BO 5213716
Material	brass
Width	ø40 mm
Height	– mm
Depth	35 mm

❗ Glass thickness tempered glass 6, 8, 10 mm · Drill hole in glass ø10 mm

Shower Doorknob, both sides



FINISH	ART. NO.
shiny chrome-plated	BO 5213722
Material	brass
Width	ø30 mm
Height	– mm
Depth	30 mm

❗ Glass thickness tempered glass 6, 8, 10 mm · Drill hole in glass ø10 mm

Shower Doorknob Crystal Glass, both sides



FINISH	ART. NO.
transparent	BO 5213781
Material	Glass
Width	ø37 mm
Height	– mm
Depth	35 mm

❗ Glass thickness tempered glass 6, 8, 10 mm · Drill hole in glass ø12 mm

Shower Doorknob, both sides



FINISH · MATERIAL · WIDTH · DEPTH	ART. NO.
shiny chrome-plated · brass	BO 5206702
shiny chrome-plated · zinc	BO 5206700

Height	– mm
Width	ø 35 mm
Depth	35 mm

i Glass thickness tempered glass 6, 8 mm · Drill hole in glass ø12 mm

Shower Doorknob, both sides



FINISH	ART. NO.
shiny chrome-plated	BO 5213701
stainless steel look	BO 5213700

Material	aluminium
Width	ø40 mm
Height	– mm
Depth	16 mm

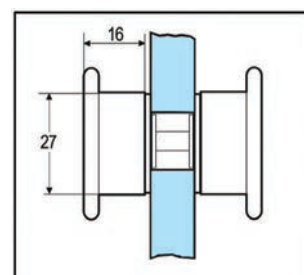
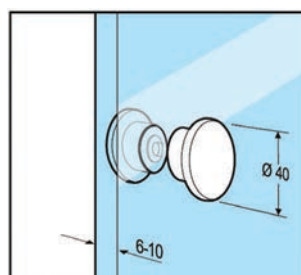

i Glass thickness tempered glass 6, 8, 10 mm · Drill hole in glass ø16 mm

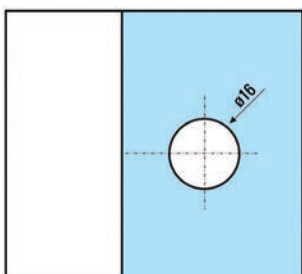

Shower Doorknob, both sides



i Glass thickness tempered glass 6, 8, 10, 12 mm · Drill hole in glass $\varnothing 14$ mm · With one-sided buffer

FINISH	ART. NO.
shiny chrome-plated	BK 0501331
Material	brass
Width	$\varnothing 35$ mm
Height	– mm
Depth	17 / 35 mm

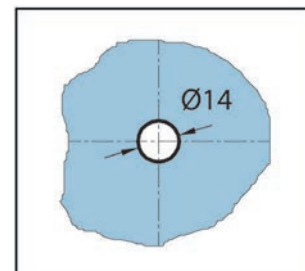
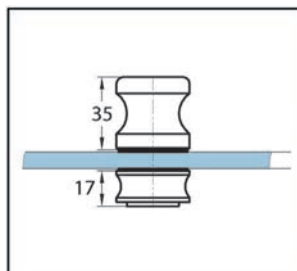

Shower Doorknob, both sides



i Glass thickness tempered glass 6, 8, 10, 12 mm · Drill hole in glass $\varnothing 14$ mm · With double-sided buffer

FINISH	ART. NO.
shiny chrome-plated	BK 0501531
Material	brass
Width	$\varnothing 35$ mm
Height	– mm
Depth	37 mm

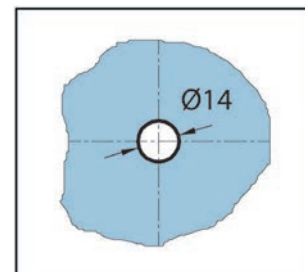
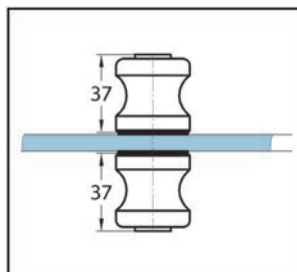

Shower Doorknob, both sides



1 Glass thickness tempered glass 6, 8, 10 mm · Drill hole in glass $\varnothing 12$ mm

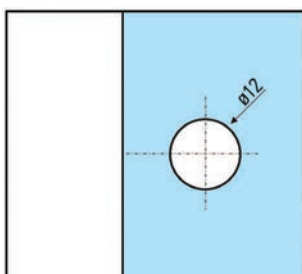

FINISH	ART. NO.
shiny chrome-plated	BO 5213751

Material	brass
Width	$\varnothing 40$ mm
Height	– mm
Depth	37 mm

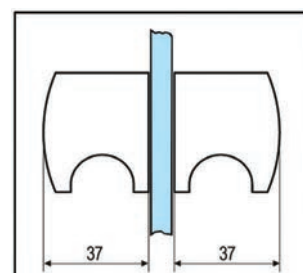
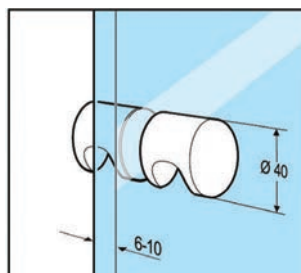

Shower Doorknob, single sided



1 Glass thickness tempered glass 4, 6, 8 mm · Drill hole in glass $\varnothing 8$ mm

FINISH	ART. NO.
shiny chrome-plated	BO 5213771

Material	brass
Width	$\varnothing 22$ mm
Height	– mm
Depth	29 mm

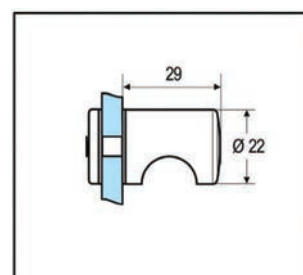
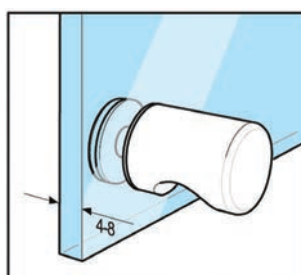

Shower Doorknob, both sides



FINISH	ART. NO.
shiny chrome-plated	BO 5206704
Material	brass
Width	ø35 mm
Height	– mm
Depth	42 mm

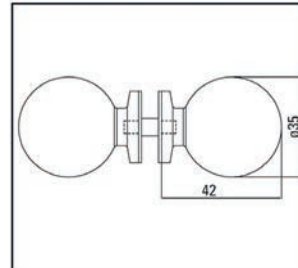

i Glass thickness tempered glass 6, 8, 10 mm · Drill hole in glass ø12 mm

Shower Doorknob, both sides



FINISH	ART. NO.
shiny chrome-plated	BK 0503031
stainless steel look	BK 0503055
Material	brass
Width	30 mm
Height	30 mm
Depth	30 mm

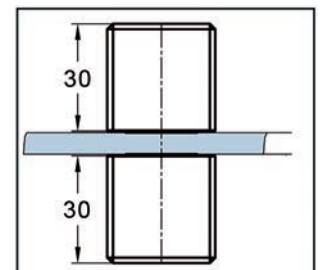
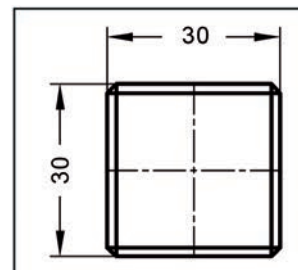

i Glass thickness tempered glass 8, 10 mm · Drill hole in glass ø12 mm

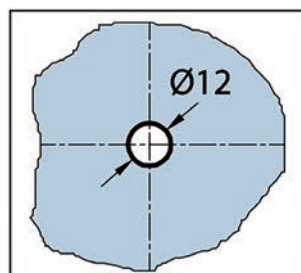
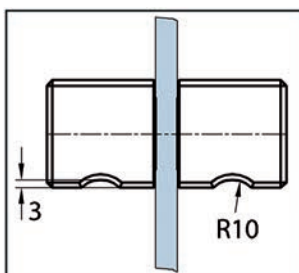

Shower Doorknob, both sides



i Glass thickness tempered glass 6, 8, 10, 12 mm · Drill hole in glass $\varnothing 10$ mm

FINISH	ART. NO.
shiny chrome-plated	BO 5206711
stainless steel look	BO 5206713

Material	brass
Width	30 mm
Height	25 mm
Depth	30 mm

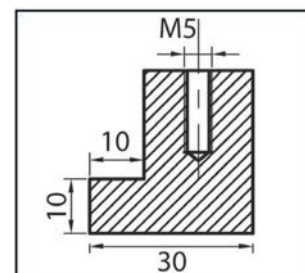
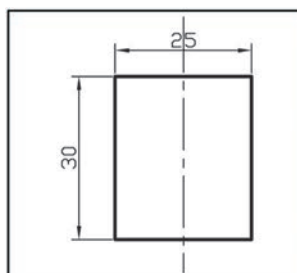

Shower Doorknob, both sides



i Glass thickness tempered glass 6, 8, 10, 12 mm · Drill hole in glass $\varnothing 10$ mm

FINISH	ART. NO.
shiny chrome-plated	BO 5206714

Material	brass
Width	50 mm
Height	50 mm
Depth	35 mm

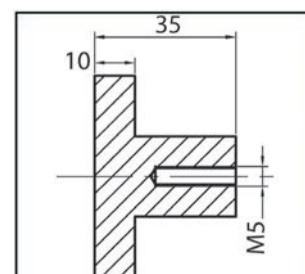
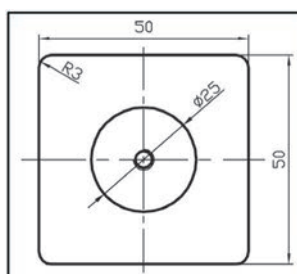

Shower Doorknob, both sides



FINISH	ART. NO.
shiny chrome-plated	BO 5206717
Material	brass
Width	70 mm
Height	30 mm
Depth	30 mm

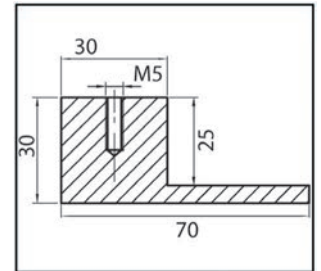
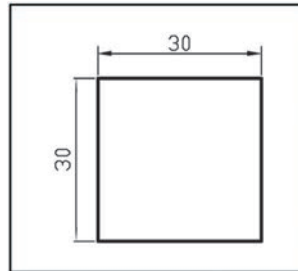

i Glass thickness tempered glass 6, 8, 10, 12 mm · Drill hole in glass \varnothing 10 mm

Shower Door Handle, both sides



FINISH	ART. NO.
brushed	BO 5212510
polished	BO 5212511
Material	stainless steel
Width	\varnothing 19 mm
Height	(L) 171 mm
Depth	60 mm

i Glass thickness tempered glass 6, 8, 10, 12 mm · Distance between centre drill holes (C-C) 152 mm · Drill hole in glass \varnothing 10 mm



Shower Door Handle, both sides



i Glass thickness tempered glass 6, 8, 10, 12 mm · Distance between centre drill holes (C-C) 203 mm · Drill hole in glass \varnothing 10 mm

FINISH	ART. NO.
brushed	BO 5212514
polished	BO 5212515
Material	stainless steel
Width	\varnothing 19 mm
Height	(L) 222 mm
Depth	60 mm



Shower Door Handle, both sides



i Glass thickness tempered glass 6, 8, 10, 12 mm · Distance between centre drill holes (C-C) 152 mm · Drill hole in glass \varnothing 10 mm

FINISH	ART. NO.
brushed	BO 5212520
polished	BO 5212521
Material	stainless steel
Width	19 mm
Height	(L) 171 mm
Depth	65 mm



Shower Door Handle, both sides



i Glass thickness tempered glass 6, 8, 10, 12 mm · Distance between centre drill holes (C-C) 203 mm · Drill hole in glass \varnothing 10 mm

FINISH	ART. NO.
brushed	BO 5212524
polished	BO 5212525
Material	stainless steel
Width	19 mm
Height	(L) 222 mm
Depth	65 mm



Shower Door Handle, both sides



FINISH	ART. NO.
shiny chrome-plated	BO 5212506
Material	stainless steel
Width	\varnothing 19 mm
Height	(L) 171 mm
Depth	60 mm

i Glass thickness tempered glass 6, 8, 10 mm · Distance between centre drill holes (C-C) 152 mm · Drill hole in glass \varnothing 10 mm

Shower Door Handle, both sides



i Glass thickness tempered glass 8 mm · Drill hole in glass \varnothing 12 mm · Distance between centre drill holes (C-C) 457/152 mm

FINISH	ART. NO.
polished	BO 5213849
Material	stainless steel
Width	\varnothing 19 mm
Height	(L/LC) 476/171 mm
Depth	60 mm

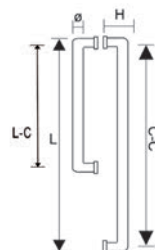

Shower Door Handle, single sided with knob



FINISH	ART. NO.
polished	BO 5215034
Material	stainless steel
Width	ø19 mm
Height	476 mm
Depth	60/8 mm

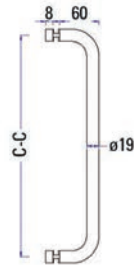

i Glass thickness tempered glass 6, 8, 10, 12 mm · Distance between centre drill holes (C-C) 457 mm · Drill hole in glass ø12 mm

Shower Door Handle, single sided with knob



FINISH	ART. NO.
polished	BO 5215035
Material	stainless steel
Width	ø19 mm
Height	629 mm
Depth	60/8 mm



i Glass thickness tempered glass 6, 8, 10, 12 mm · Distance between centre drill holes (C-C) 610 mm · Drill hole in glass ø12 mm

Shower Door Handle, single sided with knob



FINISH	ART. NO.
polished	BO 5215024
Material	stainless steel
Width	ø25 mm
Height	(L) 400 mm
Depth	65 mm

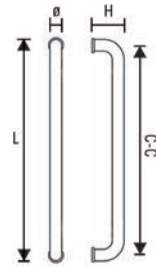

i Glass thickness tempered glass 6, 8, 10, 12 mm · Distance between centre drill holes (C-C) 375 mm · Drill hole in glass ø14 mm

Shower Door Handle, single sided with knob



FINISH	ART. NO.
polished	BO 5215025
Material	stainless steel
Width	30 mm
Height	(L) 415 mm
Depth	65 mm



i Glass thickness tempered glass 6, 8, 10, 12 mm · Distance between centre drill holes (C-C) 400 mm · Drill hole in glass ø12 mm

Shower Door Handle, single sided with knob



FINISH	ART. NO.
polished	BO 5215026
Material	stainless steel
Width	ø25 mm
Height	(L) 500 mm
Depth	65 mm



i Glass thickness tempered glass 6, 8, 10, 12 mm · Distance between centre drill holes (C-C) 475 mm · Drill hole in glass ø14 mm

Shower Door Sealing Strips

This product range shows an overview of shower door sealing strips made of plastic.

Sealing Strip with lower sealing lip and water deflector for 6 - 8 mm

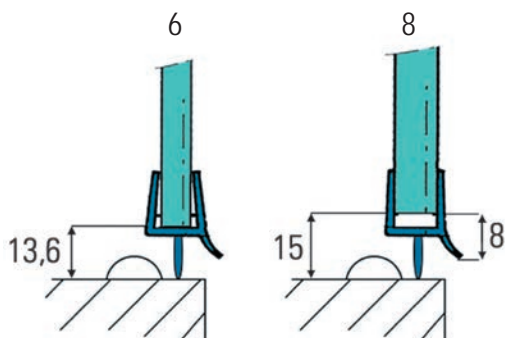

ART. NO.	BO 5213490
Length	2160 mm

• Glass thickness 6 - 8 mm · Material PVC

Sealing Strip with lower sealing lip and water deflector for 10 - 12 mm

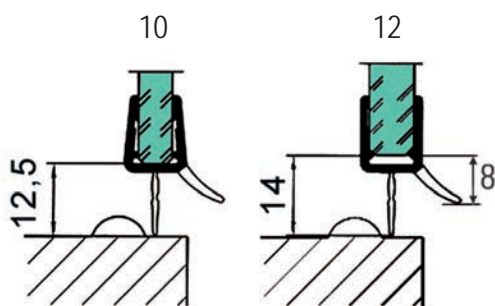

ART. NO.	BO 5281091
Length	2160 mm

• Glass thickness 10 - 12 mm · Material PVC

Sealing Strip With water deflector and lower bellows for 6 - 8 mm

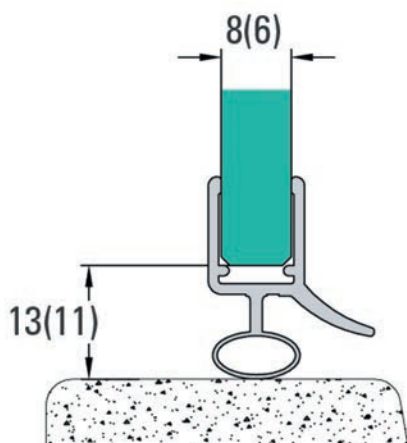

ART. NO.	BO 5213494
Length	2010 mm

• Glass thickness 6 - 8 mm · Material PVC

Sealing Strip with bellows for 6 - 8 mm

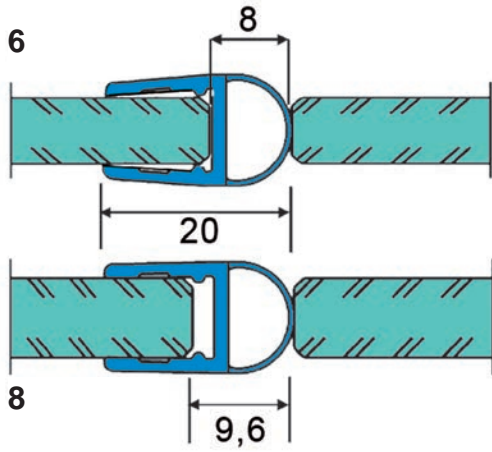

ART. NO.	
	BO 5213517
Length	2160 mm

① Glass thickness 6 - 8 mm · Material PVC

Sealing Strip with bellows for 10 - 12 mm

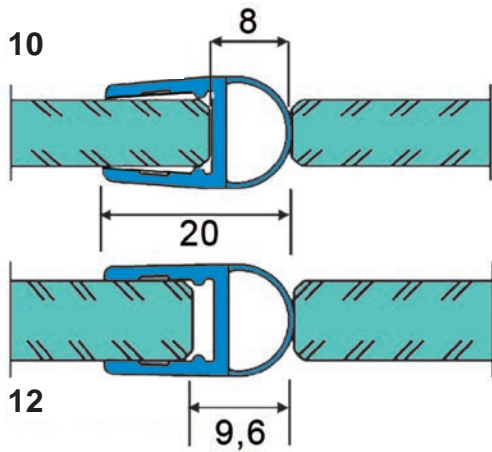

ART. NO.	
	BO 5281020
Length	2160 mm

① Glass thickness 10 - 12 mm · Material PVC

Sealing Strip with bellows for 8 mm

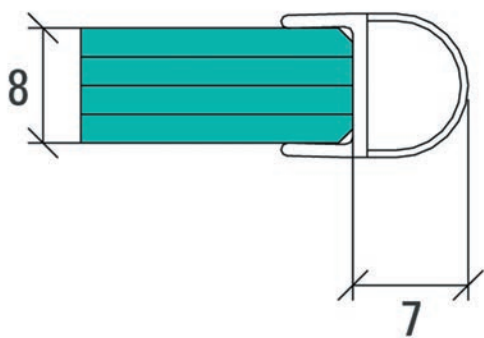

ART. NO.	
	BO 5281021
Length	2000 mm

① Glass thickness 8 mm · Material PVC

Sealing Strip 180°, for doors opening in one direction for 6 - 8 mm

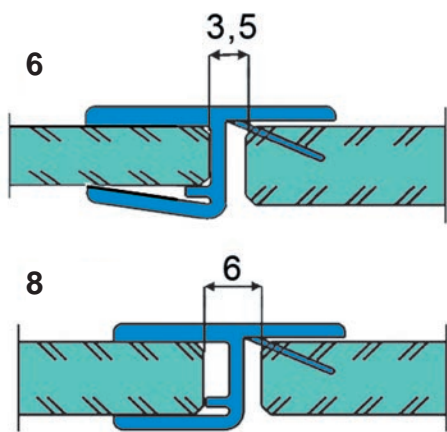

ART. NO.

BO 5213518

Length

2160 mm

① Glass thickness 6 - 8 mm · Material PVC

Sealing Strip 180°, for doors opening in one direction for 8 - 10 mm

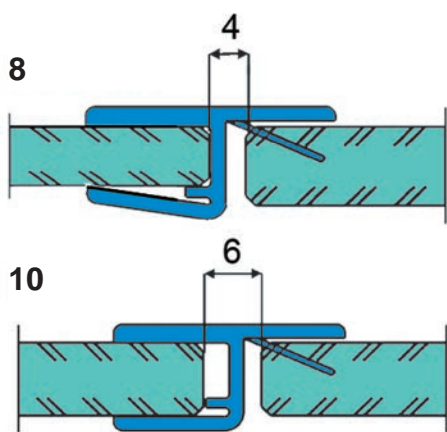

ART. NO.

BO 5281018

Length

2160 mm

① Glass thickness 8 - 10 mm · Material PVC

Sealing Strip 90°, for doors opening in one direction for 6 - 8 mm

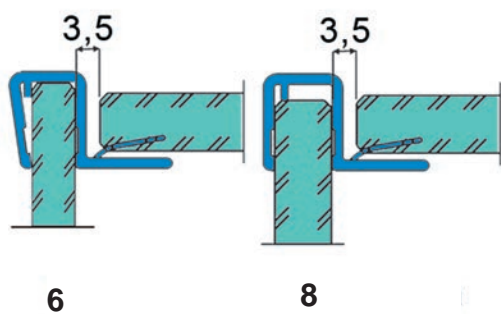

ART. NO.

BO 5213519

Length

2160 mm

① Glass thickness 6 - 8 mm · Material PVC

Sealing Strip 90°, for doors opening in one direction for 8 - 10 mm

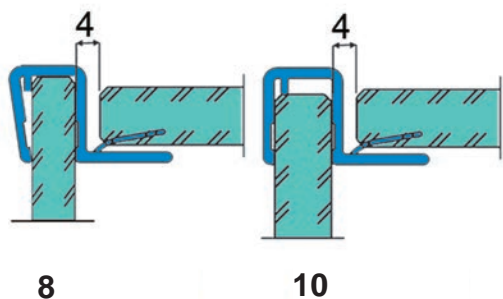

ART. NO.

BO 5281019

Length

2160 mm

i Glass thickness 8 - 10 mm · Material PVC

Sealing Strip with 135° Magnetic Profile for 6 - 8 mm

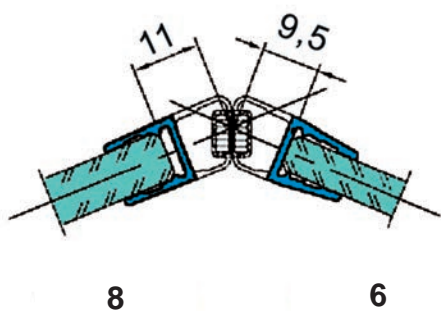

ART. NO.

BO 5213515

Length

2160 mm

i Glass thickness 6 - 8 mm · Material PVC

Sealing Strip with 135° Magnetic Profile for 10 - 12 mm

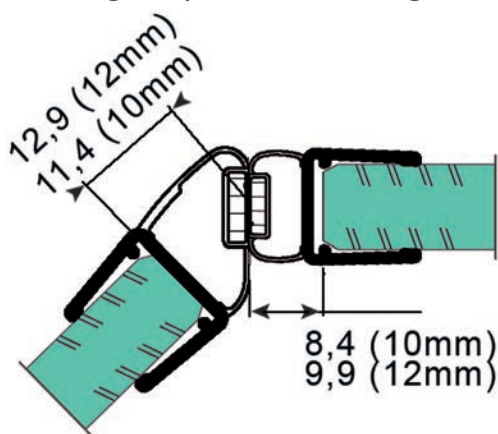

ART. NO.

BO 5281016

Length

2160 mm

i Glass thickness 10 - 12 mm · Material PVC

Sealing Strip with 90° Magnetic Profile for 6 - 8 mm

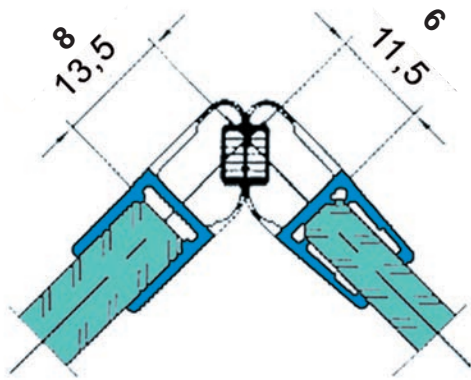

ART. NO.

BO 5213529

Length

2160 mm

① Glass thickness 6 - 8 mm · Material PVC

Sealing Strip with 90° Magnetic Profile for 10 - 12 mm

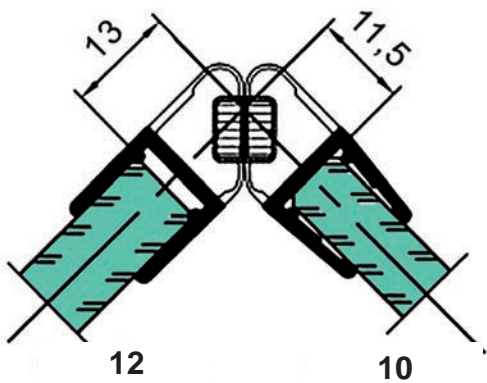

ART. NO.

BO 5281031

Length

2160 mm

① Glass thickness 10 - 12 mm · Material PVC

Sealing Strip with 180° Magnetic Profile for 6 - 8 mm

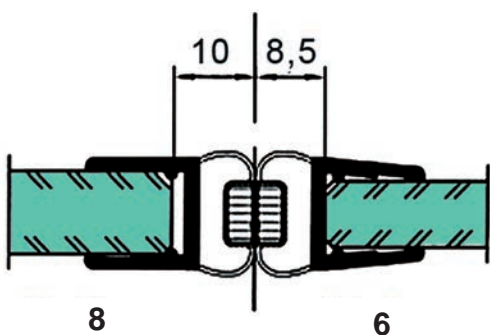

ART. NO.

BO 5213530

Length

2160 mm

① Glass thickness 6 - 8 mm · Material PVC

Sealing Strip with 180° Magnetic Profile for 10 - 12 mm

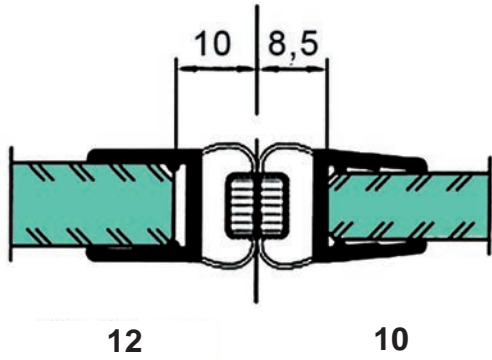

ART. NO.

BO 5281032

Length

2160 mm

i Glass thickness 10 - 12 mm · Material PVC

Sealing Strip with 90° Magnetic Profile for 6 - 8 mm

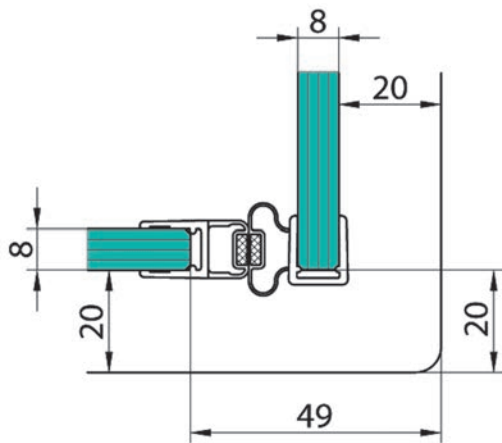

LENGTH

ART. NO.

2000 mm

BO 5281035

2500 mm

BO 5281036

i Glass thickness 6 - 8 mm · Material PVC

Sealing Strip with water deflector for 6 - 8 mm

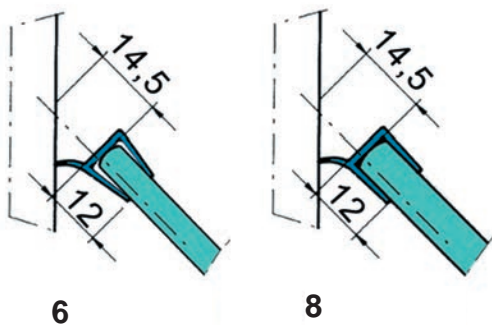

ART. NO.

BO 5213491

Length

2160 mm

i Glass thickness 6 - 8 mm · Material PVC

Sealing Strip with lateral sealing lip for 6 - 8 mm

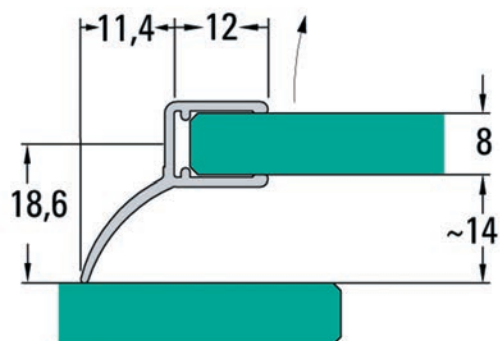

ART. NO.

BO 5281094

Length

2010 mm

i Glass thickness 6 - 8 mm · Material PVC

Sealing Strip with lateral sealing lip for 6 - 8 mm



ART. NO.

BK 69060

Length

2010 mm

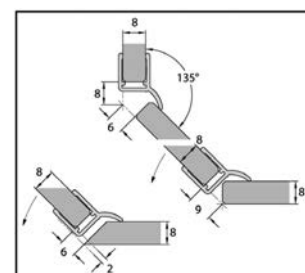
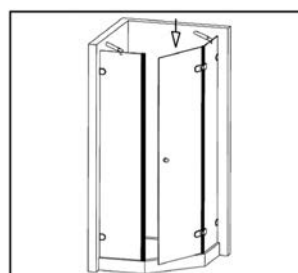

i Glass thickness 6 - 8 mm · Material PVC

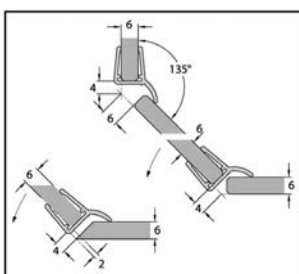

Sealing Strip With Lower Sealing Lip for 6 - 8 mm

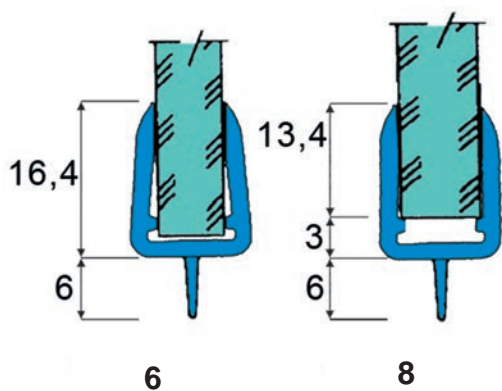

ART. NO.

BO 5213516

Length

2160 mm

i Glass thickness 6 - 8 mm · Material PVC

Sealing Strip with open sealing lip for 8 mm

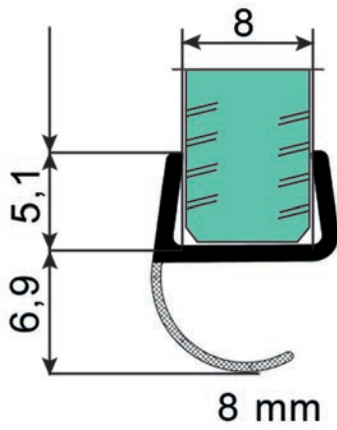

ART. NO.	
	BO 5213492
Length	2160 mm

i Glass thickness 8 mm · Material PVC

Sealing Strip with open sealing lip for 10 mm

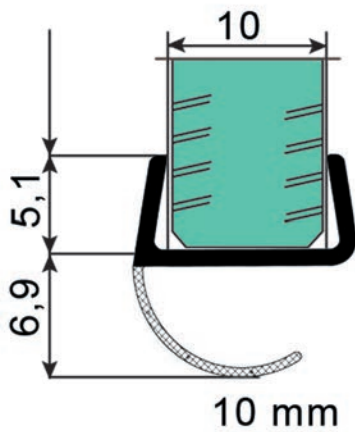

ART. NO.	
	BO 5281092
Length	2160 mm

i Glass thickness 10 mm · Material PVC

Sealing Strip with long sealing lip for 6 - 8 mm

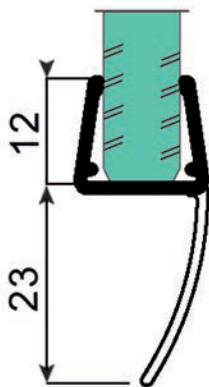

ART. NO.	
Sealing Strip	BO 5213493
Length	2160 mm

i Glass thickness 6 - 8 mm · Material PVC

Sealing Strip with long sealing lip for 10 - 12 mm

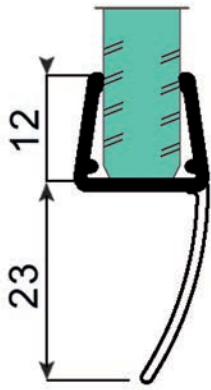

ART. NO.

BO 5281093

Length

2160 mm

① Glass thickness 10 - 12 mm · Material PVC

Sealing Strip with short sealing lip for 6 - 8 mm

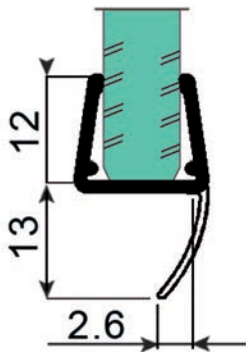

ART. NO.

BO 5281095

Length

2500 mm

① Glass thickness 6 - 8 mm · Material PVC

Sealing Strip with lateral sealing lip for 6 mm

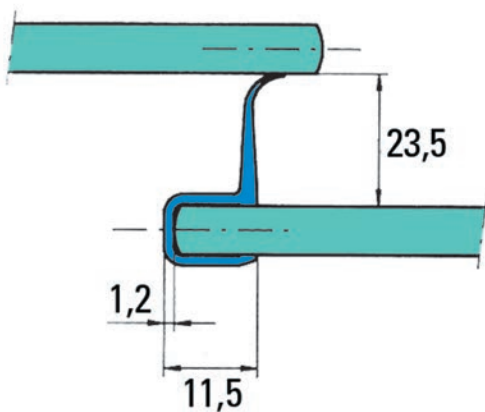

ART. NO.

BO 5213527

Length

2200 mm

① Glass thickness 6 mm · Material PVC

Sealing Strip with lateral sealing lip for 8 mm

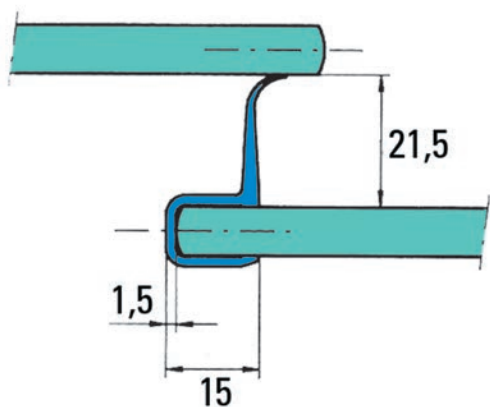

ART. NO.

BO 5213524

Length

2200 mm

i Glass thickness 8 mm · Material PVC

Sealing Strip self-adhesive with bellows for 8 - 12 mm



ART. NO.

BK 69230

Length

2500 mm

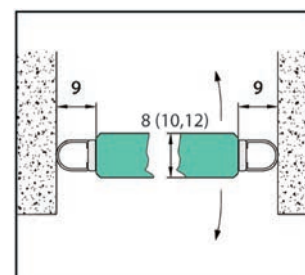

i Glass thickness 8 - 12 mm · Material PVC

Sealing Strip self-adhesive with bellows for 8 - 12 mm

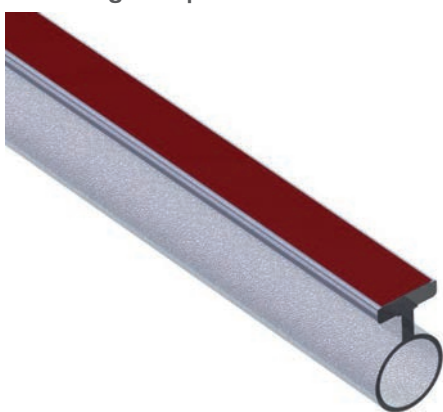

ART. NO.

BK 69240

Length

2500 mm

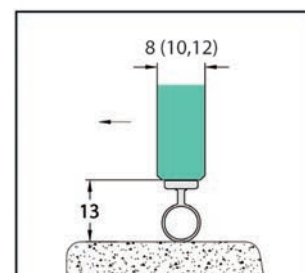

i Glass thickness 8 - 12 mm · Material PVC

Sealing Strip self-adhesive with 90° Magnetic Profile for 8 - 12 mm



i Glass thickness 8 - 12 mm · Material PVC

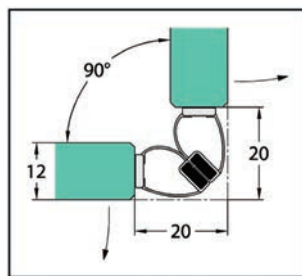
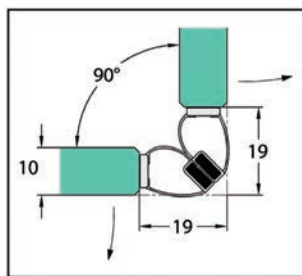

ART. NO.

BK 69250

Length

2500 mm

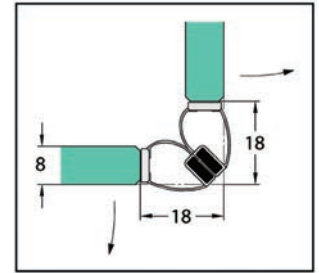
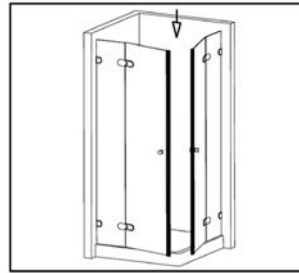

Sealing Strip self-adhesive with 180° Magnetic Profile for 8 - 12 mm



i Glass thickness 8 - 12 mm · Material PVC

ART. NO.

BK 69260

Length

2500 mm

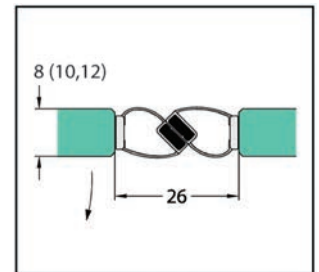
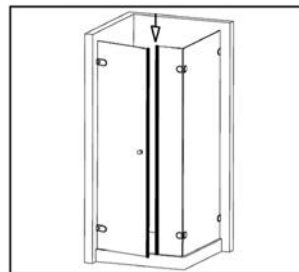

Sealing Strip self-adhesive with water deflector and lower bellows for 8 - 12 mm

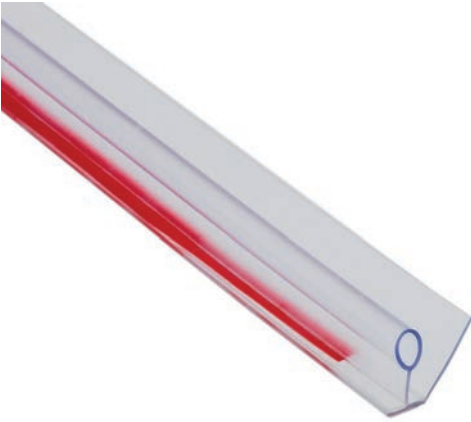

i Glass thickness 8 - 12 mm · Material PVC

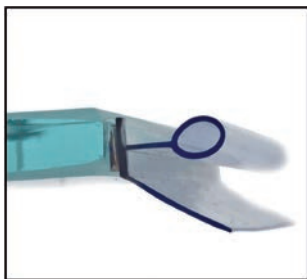

ART. NO.	BO 5200335
Length	2200 mm

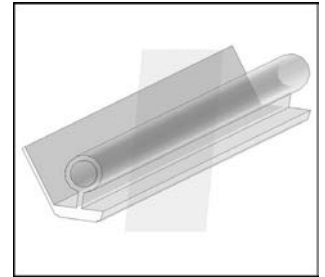
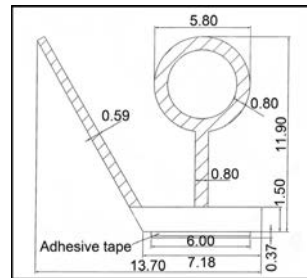

Sealing Strip self-adhesive with lateral sealing lip for 8 - 12 mm



i Glass thickness 8 - 12 mm · Material PVC

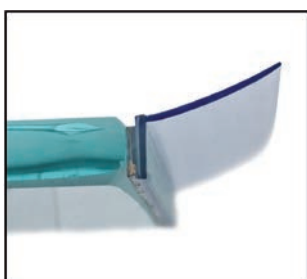

ART. NO.	BO 5200336
Length	2500 mm

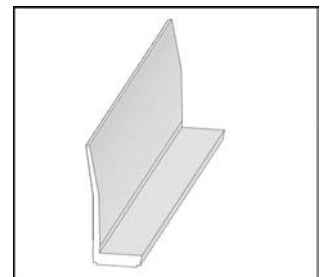
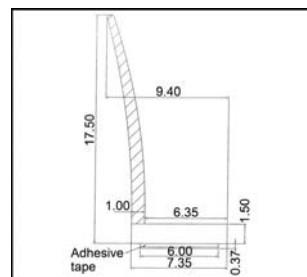

Accessories

Combination of Bathtub Attachment Profile and Magnetic Support Profile

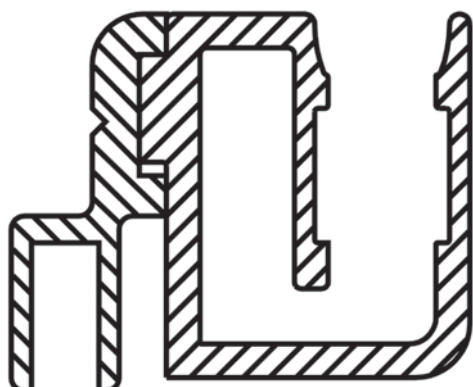

MATERIAL	ART. NO.
aluminium	BO 5281044
Length	2000 mm
Finish	polished anodised E3/EV1

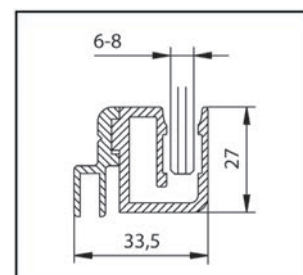
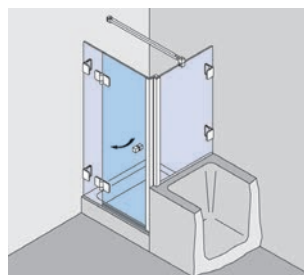

i Suitable for Sealing Strip BO 5213529, BO 5281035

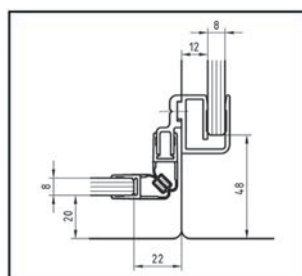
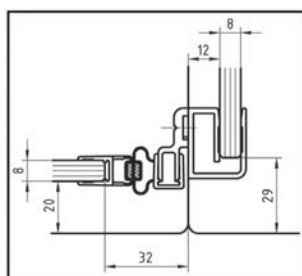

Bathtub Attachment Profile 90°

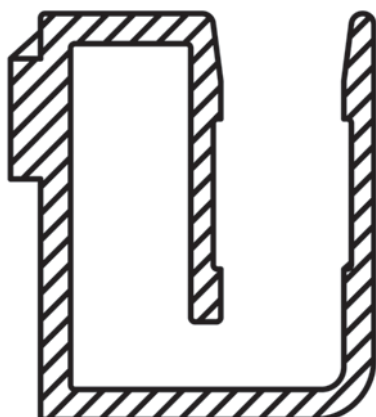

MATERIAL	ART. NO.
aluminium	BO 5281045
Length	2000 mm
Finish	polished anodised E3/EV1

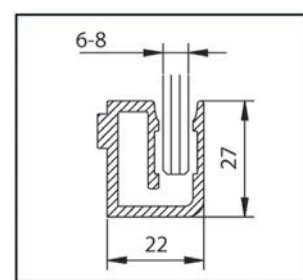
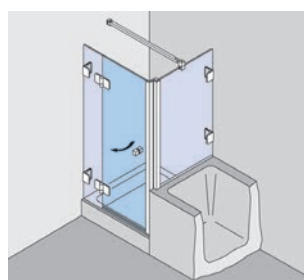

i Suitable for Magnetic Support Profile BO 5281033

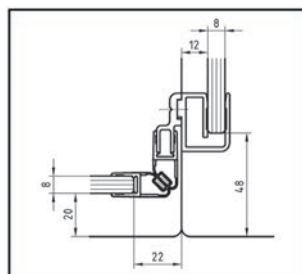
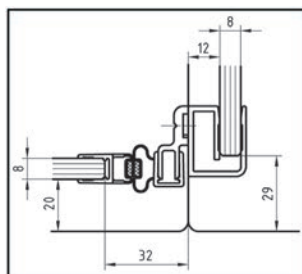

Magnetic Support Profile Recess application

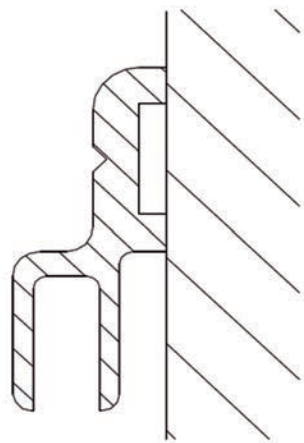

MATERIAL

ART. NO.

aluminium

BO 5281033

Length

2000 mm

Finish

polished anodised E3/EV1

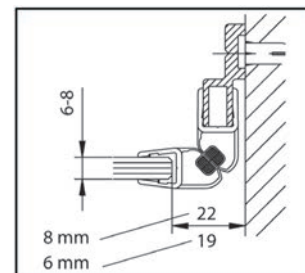
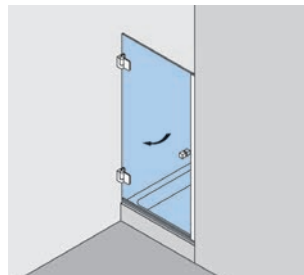

i Screws and cover plates are included in the set.

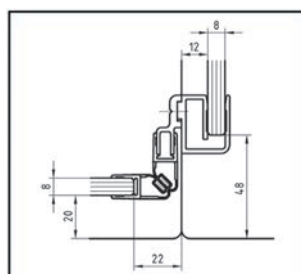
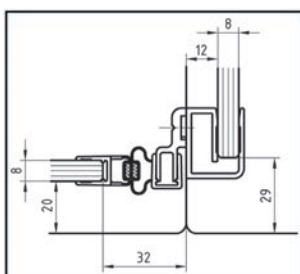

Support Profile for Sealing Strips



LENGTH · FINISH

ART. NO.

2010 mm · polished anodised E3/EV1

BO 5281040

2500 mm · polished anodised E3/EV1

BO 5281042

Material

aluminium

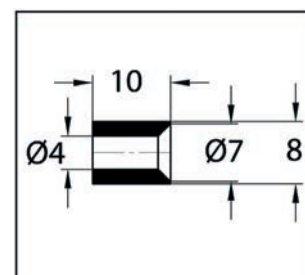

i Pre-drilled

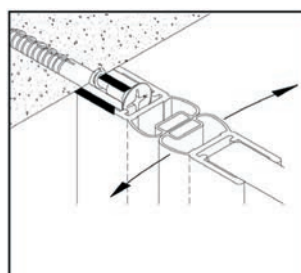
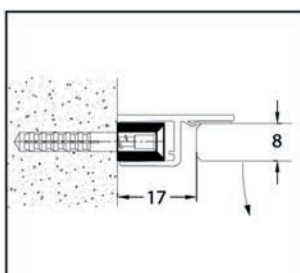

Bohle Duplocoll® Adhesive Bonding Tapes



i Thickness 3 mm · transparent · Roll length 12 m

WIDTH · GLASS THICKNESS	ART. NO.
5 mm · 8; 8.76 mm	BO 5207936
7 mm · 10; 10.76 mm	BO 5207938
9 mm · 12; 12.76 mm	BO 5207935
14 mm · 17.52 mm	BO 529630
APPLICATOR FOR	ART. NO.
8; 10 mm	BO 5207939N
10.76; 12.7; 12.76 mm	BO 5207946N
INLAY FOR	ART. NO.
10; 12 mm	BO 5207948
8.76; 10.76 mm	BO 5207947
17.52 mm	BO 5207949

Thresholds

Thresholds

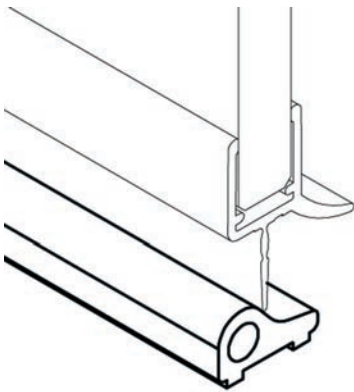

i Non self-adhesive · Threshold must be fixed individually and on site.

FINISH	ART. NO.
shiny silver coloured	BK 6907031
pure white RAL 9010	BK 6907082
Length	1800 mm

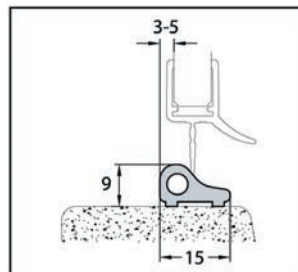

Threshold end caps

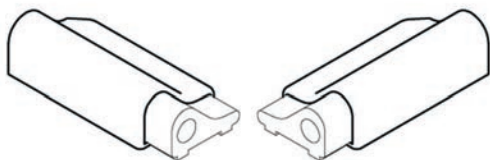

i One each on the left and right sides

FINISH	ART. NO.
shiny silver coloured	BK 6907331
pure white RAL 9010	BK 6907382

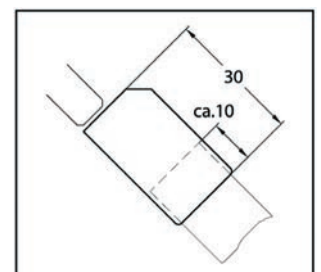
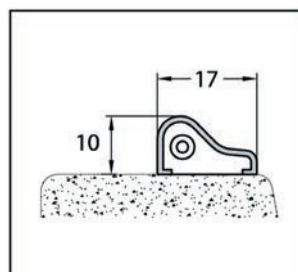

Thresholds

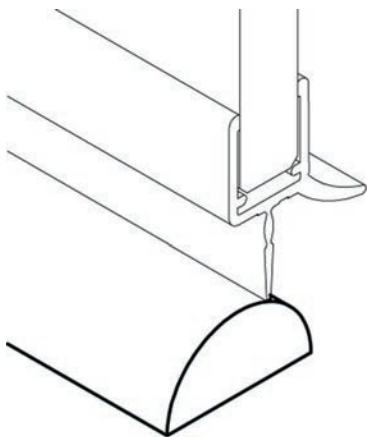

i Non self-adhesive · Threshold must be fixed individually and on site.

LENGTH	ART. NO.
1000 mm	BK 69080
2000 mm	BK 69081
Width	20 mm
Height	10 mm
Colour	transparent
Material	acrylic

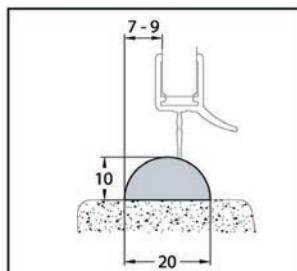

Thresholds

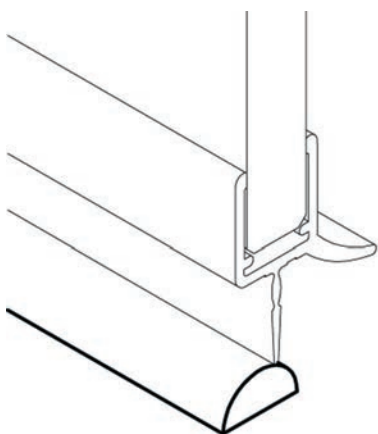

i Non self-adhesive · Threshold must be fixed individually and on site.

LENGTH	ART. NO.
1000 mm	BK 69130
2000 mm	BK 69131
Width	10 mm
Height	5 mm
Colour	transparent
Material	acrylic

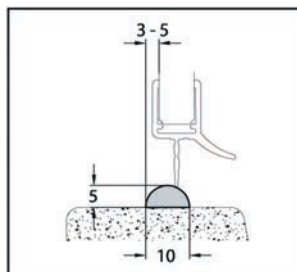

Profiles

Clamping Profile



i Glass thickness 8 mm · incl. clamping parts and cover profile

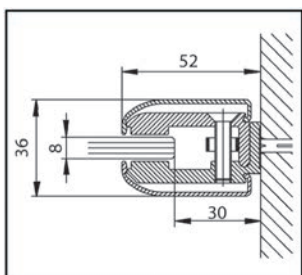

ART. NO.

BO 5281046

Finish	polished anodised E3/EV1
Size	52 x 36 x 52 mm
Material	aluminium
Length	2000 mm

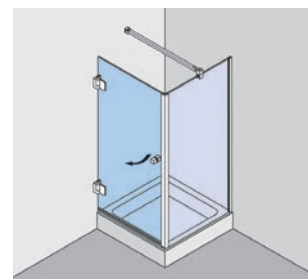

INCLUDED IN DELIVERY:

1x

2x

Clamping profile

Cover profile

Cover Cap for Clamping Profile

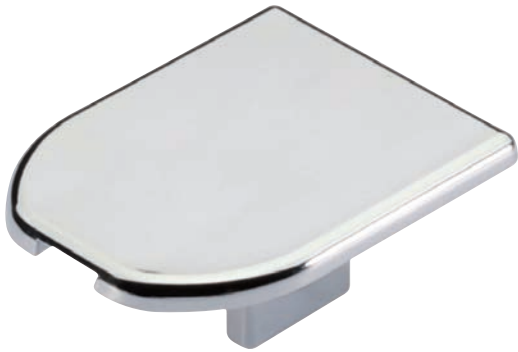

FINISH	ART. NO.
polished	BO 5281047
Material	Plastic

i Packaging unit 1 pc

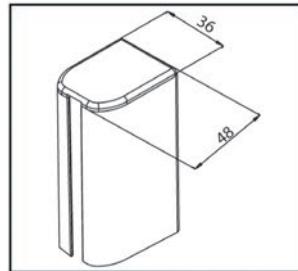

Aquant 40 Clamp-on Profile for Wall Connector

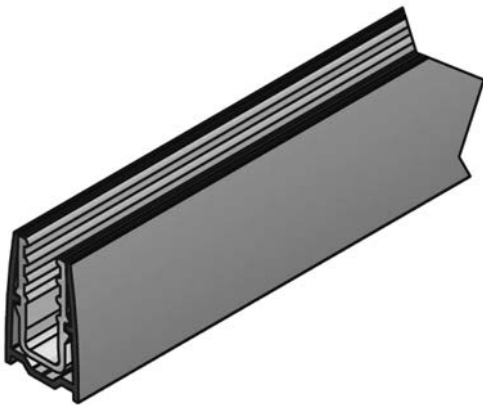

LENGTH	ART. NO.
2000 mm	BO 5215196
2490 mm	BO 5215197
Finish	polished
Size	32 x 20 x 32 mm
Material	aluminium
Shape	U

i Glass thickness 8 mm · Suitable for use with Aquant 40 sliding doors system · incl. plastic insert, no sealing required

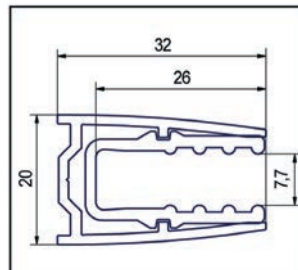

INCLUDED IN DELIVERY:

1x	Clamp-on profile
1x	Clamping insert



You will find further information (drawings, instruction manuals, etc.) in our Online Shop at www.bohle.com.

Cleaning

Bohle Premium Glass Cleaner



DESCRIPTION	ART. NO.
Contents 1 l	BO 5107805
Contents 12 l	BO 5107807
Contents 25 l	BO 5107806
Drain cock for BO 5107806	BO 5107803

i Ideal for windows, mirrors, windscreens and other glass surfaces · prevents fresh smudging · No streaking · In spray bottles without propellants · Biologically degradable · With the purchase of one carton (=12 bottles), 3 spray heads are included · Please note: Not suitable for pre-cleaning before UV bonding! Only for cleaning after bonding!

Spray Head for Glass Cleaner



DESCRIPTION	ART. NO.
Spray Head for Glass Cleaner	BO 5107810

i For BO 5107805

Bohle Glass Cleaner with your company-branded label



DESCRIPTION	ART. NO.
Citrus Glass Cleaner Your Company-Branded Label	BO 5107808

i The Bohle Professional Glass Cleaner with powerful citrus formula stands out due to its extremely high performance and streak-free brilliance. It is ideal for windows, mirrors, glass furniture, high gloss decoration, work surfaces, kitchen appliances and much more. Bohle Citrus Power leaves even living spaces, car windows and smooth interior car surfaces absolutely clean. · The perfect ad for your business: the Bohle glass cleaner in a customised bottle with your company-branded label! · Send your company logo (together with an image) in print resolution (TIFF or EPS, 300 dpi) to privatelabel@bohle.de. · Please also include the corresponding address and text to be printed on the label, and specify your in-house font (including typeface if necessary). · Please be aware when using an image that it will be surrounded by a 3 mm rim. · Please be aware that the text cannot be displayed in a font size smaller than 7 pt. · You will receive a pdf file for sign off and, upon request, the original label. · Packaging unit: 40 bottles · Minimum order quantity: 120 bottles · Contents 500 ml, incl. spray Head

Not sold in the UK or ROI.

Bohle Glass Cleaner



DESCRIPTION	ART. NO.
Bohle Glass Cleaner with Citrus Power	BO 5107809

i The Bohle Professional Glass Cleaner with powerful citrus formula stands out due to its extremely high performance and streak-free brilliance. It is ideal for windows, mirrors, glass furniture, high gloss decoration, work surfaces, kitchen appliances and much more. Bohle Citrus Power leaves even living spaces, car windows and smooth interior car surfaces absolutely clean. · Packaging unit: 40 bottles · Contents 500 ml, incl. spray Head

Not sold in the UK or ROI.

Bohle Professional Glass Cleaner



DESCRIPTION	ART. NO.
Spray can of 660 ml	BO 5107900
For quantities of 600 +/- 10%, available with your own label.	BO 5107905

i Can be used for glass, smooth plastic surfaces, mirrors, car windows, tiles · For workshop and home, showcases and display windows · Sparkling surfaces without streaking · Environmentally sound propellant · Ideal for cleaning glass parts after fusing ·

Please note: Not suitable for pre-cleaning before UV bonding! Only for cleaning after bonding! · For quantities of 600 +/- 10%, available with your own label. Contact sales on freephone 0800 616151 for up to date prices.

Bohle Special Cleaner



DESCRIPTION	ART. NO.
Refill 1 l	BO 5107911
Refill 27 l	BO 5107912
Empty bottle 0,25 l for Bohle special cleaner	BO 5107914

i Ideal for preliminary cleaning prior to glass bonding or sealing. The Bohle Special Cleaner cleans and degreases glass, metal, ceramic and rubber. The special composition of the cleaner ensures very thorough cleaning.

Empty bottle for Bohle special cleaner



DESCRIPTION	ART. NO.
Empty bottle 0,25 l for Bohle special cleaner	BO 5107914

i Convenient working thanks to handy size and assembled spray head · Spray head BO 5107810 pre-assembled · For decanting 1l or 27l of Bohle Special Cleaner · Empty bottle with label and spray head - 250 ml

Window Washer Economy



DESCRIPTION	ART. NO.
Window Washer Economy	BO 5107811

i Ideal as low-cost give-away for your customers! · Plastic wiper for shower cubicles with soft rubber lip for streak free cleaning of glass surfaces. Includes hook. · Packaging unit 25 items · Width 23 cm

Cleaning Cloth Big Wipes Heavy Duty



DESCRIPTION

ART. NO.

80 wipes per box

BO 5141626

i Double-sided industrial cleaning cloths. The coarse side removes stubborn dirt · The smooth side absorbs the dirt · For quick and thorough cleansing · Removes: paints, adhesives, uncured PU foam, bitumen, silicon and oil from hands, tools and surfaces · Dermatologically tested, free from preservatives, with integrated skin care: contains aloe vera, lanolin, glycerol and vitamin E · Antibacterial effect: eliminates 90% of all bacteria

Paper Towels

Paper Towel Dispenser



DESCRIPTION	ART. NO.
Paper Towel Dispenser	BO 5141616

i Paper towel dispenser, floor model for jumbo rolls · Paper towels and bin liners are not included

Paper Towels Economy 2-ply 420 sheets



	ART. NO.
Paper Towels	BO 5141621

i Paper Towels · white · 2-ply · Packaging unit 6 pc. · Quantity: 420 sheets à 20 x 38 cm (W x L)

Paper Towels Economy 2-ply 1000 sheets



DESCRIPTION	ART. NO.
white	BO 5141620
blue	BO 5141621

i Paper Towels · 2-ply · Suitable dispenser BO 5141616 · Packaging unit 2 pc. · Quantity: 1000 sheets 24 x 38 cm (W x L) · Weight: 2 x 18 g/m²

Paper Towels Premium 4-ply 1000 sheets



DESCRIPTION	ART. NO.
Paper Towels	BO 5141625

i Paper Towels - 4-ply - white - Suitable dispenser BO 5141616 - Packaging unit 2 pc. - Quantity: 1000 sheets 38 x 38 cm (W x L)

Special UV Wiping Cloths



DESCRIPTION	ART. NO.
Special UV Wiping Cloth	BO 5141630

i Textile-like polishing and wiping cloths - 70% viscose, 30% polyester
· For removing liquid and solid materials from scratch-sensitive surfaces
· Dispenser box of 275 cloths · Especially suitable for removing adhesive residues after pre-curing · Colour white · Cloth size: 40 x 38 cm · Weight: 50 g/m²

Microfibre Cloths Economy



ART. NO.

BO 5141642

i For streak-free cleaning of all smooth and porous surfaces, even without using chemical agents · Washable up to 90°C · Size 40 x 38 cm · Weight 100 g/m² · Material fleece · Packaging unit 5 items

BriteGuard®

BriteGuard® Surface SEALER



DESCRIPTION	ART. NO.
Contents 500 ml	BO 5810500
Contents 5 l	BO 5815000

Surface SEALER is suitable for all smooth glass or glazed ceramic surfaces. It makes no difference whether the coated material will be used indoors or outdoors or whether you want to protect showers, partitions, conservatories, facades or glass furniture. Included in the delivery of the 0.5 litre bottle is a BO 5107810 spray head. Please note: 5 l containers can only be shipped outside Germany via a forwarding agent. Shelf life in original packaging: 12 months from the date of manufacture

BriteGuard® Surface SEALER X



DESCRIPTION	ART. NO.
Contents 500 ml	BO 5820500
Contents 5 l	BO 5825000

Surface SEALER X was specially developed for rough surfaces. This can be glass that is satin finished or sandblasted. Included in the delivery of the 0.5 litre bottle is a BO 5107810 spray head. Please note: 5 l containers can only be shipped outside Germany via a forwarding agent. Shelf life in original packaging: 12 months from the date of manufacture. The material is not suitable for exterior application. If you have questions, please contact our application technicians.

BriteGuard® Surface ACTIVATOR



DESCRIPTION	ART. NO.
Contents 1 l	BO 5831000
Contents 5 l	BO 5835000

For pre-cleaning smooth glass/glazed ceramic surfaces before applying Surface SEALER.

BriteGuard® Surface FINISHER



DESCRIPTION	ART. NO.
Contents 1 l	BO 5841000
Contents 5 l	BO 5845000

i For easy removal of excess material after applying Surface SEALER

BriteGuard® Express



DESCRIPTION	ART. NO.
Contents 100 ml	BO 5850010
Contents 500 ml	BO 5850050
Contents 5 l	BO 5850000

i Protect your showers quickly and easily before mounting with BriteGuard® Express. The coated glass surface is protected immediately and can be cleaned easily. In this way your customer will enjoy a high quality shower for a long time. Its use is as easy as can be. The special liquid is simply applied evenly onto the clean glass surface and is wiped off again with a suitable cloth. The only thing you have to be aware of is to moisten surfaces completely and evenly. The protective effect is activated immediately. The one-step product is appropriate for interior and exterior application. It can be used as efficiently on glass showers and partitions as on conservatory roofs. · Quick protection for all smooth glass surfaces · Simple application - Clean the glass pane, apply BriteGuard® Express uniformly with a spray bottle and polish. · The surface becomes hydrophobic immediately (water drips off) · The glass remains protected & easy to clean for several months · Can be reapplied at any time · For professional requirements and for use at home

BriteGuard® Limescale Remover



DESCRIPTION	ART. NO.
Contents 1 l	BO 5881001
Contents 5 l	BO 5885001

i BriteGuard® Limescale Remover is a mild, slightly viscous cleaner on the basis of natural organic acids. It is conceived for easy removal of stubborn limescale deposits. The product is suitable for use on glass or ceramic, metal and other acid-proof surfaces. Especially sensitive, high-quality materials can be cleaned gently. In case of unknown surfaces, check them for suitability in an unobtrusive area. BriteGuard® Limescale Remover was developed for removing limescale deposits. In addition, water may also contain other particles which can leave residues on the surface. These might need to be removed with an additional cleaner. For maintenance cleaning, apply the Limescale Remover diluted in a ratio of 1:5 to 1:10 and allow it to take effect. Subsequently, remove the dirt with a soft pad or a brush and rinse with plenty of water. Can be used undiluted for extreme contamination, repeat the cleaning procedure if necessary. · For sensitive surfaces · powerful · Mild, natural acid components · Slightly viscous · Environmentally friendly and biologically degradable

XtraClean Cleaning Paste



DESCRIPTION	ART. NO.
Contents 100 g	BO 5886001

i Thanks to millions of microparticles, XtraClean is capable of removing deposits, building dirt or rust from glass, stainless steel, ceramic, tile joints and other hard surfaces. It even masters concrete splatters and oil deposits effectively or cleans dirty machines which look like new again in no time. The effect of the cleaning particles is further enhanced by surfactants which improve the solubility of greasy stains as well as by essential oils set free during cleaning. The following applies: The higher the temperature during cleaning, the more essential oils are set free and the more economical is the cleaning paste.

Accessories

Disposable Gloves, Latex



DESCRIPTION	ART. NO.
Size L	BC 5050300

i Protect against possible skin irritations or allergic reactions when using various chemicals · Contents 100 items

Dermatril Disposable Gloves



SIZE	ART. NO.
M	BO 5007520
L	BO 5007519
XL	BO 5007510
XXL	BO 5007516

i Offering greater mechanical resistance than conventional disposable latex gloves · Chemical protection class III · Performance class as per EN 374 with AQL 0.653 · Package with 100 pieces

Microfibre Cloths Premium



	ART. NO.
Microfibre Cloths	BC 5056000

i Industrial quality microfibre cloths for drying and polishing treated or untreated glass surfaces. · Contents 10 items

Bucket



	ART. NO.
Bucket	BC 5057000

i Water bucket, blue - Size 50 cm - Suitable for window washers up to a width of 45 cm

Pad Holder and Pads



DESCRIPTION	ART. NO.
Pad Holder small - grey	BC 5058300
Pad holder large blue	BC 5058310
Pad small	BC 5058400
Pad large	BC 5058450

i Suitable for pre-cleaning with Surface Activator before coating with Surface Sealer. - Also suitable for removing excess material with Surface Finisher after coating. - To prevent the products from becoming mixed, please use a separate pad for each product.

Cotton Pads



	ART. NO.
Cotton Pads	BO 5052065

i Pure cotton pads - 8 x 10 cm (length x width) - Contents 20 items

Empty Bottle



DESCRIPTION	ART. NO.
500 ml	BO 5810502
1000 ml	BO 5810503

❗ Empty bottle for universal use, e.g. for applying coating products using spray gun BO 5107810

BriteGuard® Sticker



	ART. NO.
BriteGuard® Sticker	BO 5830010

❗ For labelling glass coated with BriteGuard® · roll of 100 items · 30 × 15 mm · Colour transparent / blue

Window Washer with Fleece



DESCRIPTION · WIDTH	ART. NO.
Window wiper with fleece, 35cm	BO 5553200

❗ Window washer with lint-free, easy-to-exchange fleece cover for general cleaning of glass surfaces. · Complete Set · 35 cm

Window Wiper Handle



DESCRIPTION	ART. NO.
Window Wiper Handle	BO 5551200

i Made of rustproof steel

Rail with Rubber Strip



	ART. NO.
Rail with Rubber Strip	BO 5551300

i Wiping rail with rubber strip suitable for handle BO 55 512 00

In regard to this catalogue

With the printing of this catalogue, all previous catalogues and price lists, or parts thereof, are no longer valid. Our offers apply to retail, trade and industry. Technical specifications (dimensions, weights, materials, etc.) and other specifications (design, colour, etc.) are subject to change. The range of products can change during the time this catalogue is current. In particular, we reserve the right to remove individual articles without prior notice. Please request further details from your Bohle contact person. Print-related colour variations are possible. Bohle AG is not liable for any printing or other errors and omissions in this catalogue. For many of the articles protective rights such as patents, trademarks, design copyrights, etc. have been registered or are pending registration - also by third parties.

© Copyright by Bohle - This catalogue is protected in all parts (texts, photos, images etc.) by copyright. Any use outside the strict limits of copyright laws without written permission of Bohle AG is not permitted. This applies in particular to duplications, reprints, translations, microfilming as well as saving and processing in electronic systems.

October 2018.

A

Adhesive Bonding Tape Duplocoll®	167
Aqua Adapter Profile for fixed sidelight for 6 mm	91
Aqua Adapter Profile for fixed sidelight for 8 mm	91
Aqua Shower Door Hinges	89
Aquant 40	
Accessory Installation	111
Accessory Kit Corner Bracket	112
Accessory Kit Door Sash	110
bulb seal for recess shower application	112
Clamp-on Profile for Wall Connection	113
Clamp-on Profile for Wall Connector	170
Handle Ø 39 mm	111
Profile Set	110
Aquant 40 Set, corner application	
with damping mechanism, double doors	107
with damping mechanism, single door	106
Aquant 40 Set, recess application	
with damping mechanism, double doors	109
Aquant 40 vertical sealing strips	112
Art Shower Door Hinges	92

B

Barcelona Select Shower Door Hinges	54
Barcelona Shower Door Hinges	60
Bathtub Attachment Profile 90°	165
Bella Shower Door Hinges	14
Bilbao Premium Shower Door Hinges	38
Bilbao Select Shower Door Hinges	44
Bilbao Shower Door Hinges	50
Bohle Duplocoll® Adhesive Bonding Tapes	167
Bohle round	126
Ø 12 mm	127
Ø 19 mm	129
Bohle Special Cleaner	173
Bohle square	117
12 x 12 mm	125
15 x 15 mm	118
Bohle Telescopic round Ø 19 mm	137
BriteGuard®	177
Express	178
Limescale Remover	179
Sticker	182
Surface ACTIVATOR	177
Surface FINISHER	178
Surface SEALER	177
Surface SEALER X	177
Bucket	181

C

Clamping Profile	169
Cleaning	171
Cleaning Cloth Big Wipes Heavy Duty	174
Combination of Bathtub Attachment Profile and Magnetic Support Profile	165
Connector 180°	
Bohle round Ø19 for 10 - 12 mm	136
Bohle round Ø19 for 6 - 8 mm	136
with Glass Connector Bohle round Ø19	132
with Glass Connector Bohle square 15x15	121
Connector	
adjustable 90°-180° Bohle round Ø19	135
Barcelona glass/wall 90°	58, 62
Bilbao glass/wall 90°	47, 51
Europe glass/wall 90°	71
Granada 90° glass/wall	77
with Glass Connector Bohle round Ø19	135
Corner Clamp	
Art glass / wall 90°	94
Art glass/glass 90°	95
Barcelona glass/glass 90°	58, 62
Barcelona glass/wall 90°	59, 63
Bella glass/glass 90°	17
Bella glass/wall 90°	17
Bilbao glass/glass 90°	48, 52
Bilbao glass/wall 90°	48, 52
Bilbao Premium glass/wall 90°	43
Bilbao Premium HD glass/wall 90°	42
Easy glass/glass 90°	99
Easy glass/wall 90°	98
Europe glass/glass 90°	72
Europe glass/wall 90°	72
Granada glass/glass 90°	77
Granada glass/wall 90°	76
Lugo glass/glass 90°	22
Lugo glass/wall 90°	22
Madrid glass/glass 90°	13
Madrid glass/wall 90°	13
Milano Original / Milano Premium glass/glass 90°	67
Milano Original / Milano Premium glass/wall 90°	67
Next glass/wall 90°	81
Corner Clamp Plan Artist	
glass/glass 135°	88
glass/glass 90°	88
glass/wall 90° Screw-on plate inwards	87
glass/wall 90° Screw-on plate outwards	87
Corner Clamp Wellness®	
glass/glass 135°	29
glass/glass 90°	28
glass/wall 135°	29
glass/wall 90°	27, 28
Corner Connector	
135° with Glass Connector Bohle round Ø19	133
90° Bohle round Ø19	136
90° with Glass Connector Bohle round Ø19	133
adjustable 90°-180° Bohle square 15x15	122
adjustable with Glass Connector Bohle square 15x15	123

Cotton Pads	181
Cover Cap for Clamping Profile	170

D

Dermatril Disposable Gloves	180
Disposable Gloves, Latex	180
Duplocoll® Adhesive Bonding Tape	167

E

Easy Shower Door Hinges	96
Empty Bottle	182
Empty bottle for Bohle special cleaner	173
Europe Shower Door Hinges	69

G

Glass Cleaner	172
Glass Cleaner with your company-branded label	172
Glass Connector	
adjustable Bohle round ø19	130
adjustable Bohle round ø19 for 10 - 12 mm	130
adjustable Bohle round ø19 for 6 - 8 mm	129
adjustable Bohle square 15x15	123
Granada Shower Door Hinges	73

L

Lugo Shower Door Hinges	18
-------------------------	----

M

Madrid Shower Door Hinges	10
Magnetic Support Profile Recess application	166
Microfibre Cloths Economy	176
Microfibre Cloths Premium	180
Milano Original Shower Door Hinges	64

N

Next Shower Door Hinges	78
-------------------------	----

P

Pad Holder and Pads	181
Paper Towel Dispenser	175
Paper Towels	175
Economy 2-ply 1000 sheets	175
Economy 2-ply 420 sheets	175
Premium 4-ply 1000 sheets	176
Plan Artist Shower Door Hinges	82
Premium Glass Cleaner	171
Premium Slide SH Set	
corner application, double doors	104
corner application, single door, with sidelight	103
recess application, single door	102
Premium Slide SH Sliding Shower Door System	101
Professional Glass Cleaner	172
Profiles	169

R

Rail with Rubber Strip	183
Reinforcement Bars	117
Bohle round ø19	129
Bohle square 15x15	124
Reinforcement Bar Set	
Bohle round ø12 glass/wall 90°	127
Bohle square 12x12 glass/wall 90°	125
Bohle square 15x15 glass/glass	119
Bohle square 15x15 glass/wall 45°	119
Bohle square 15x15 glass/wall 90°	118

S

Sealing Strip 180°	
for doors opening in one direction for 6 - 8 mm	155
for doors opening in one direction for 8 - 10 mm	155
Sealing Strip 90°	
for doors opening in one direction for 6 - 8 mm	155
for doors opening in one direction for 8 - 10 mm	156
Sealing Strip self-adhesive	
with 180° Magnetic Profile for 8 - 12 mm	163
with 90° Magnetic Profile for 8 - 12 mm	163
with bellows for 8 - 12 mm	162
with lateral sealing lip for 8 - 12 mm	164
with water deflector and lower bellows for 8 - 12 mm	164
Sealing Strip	
with 135° Magnetic Profile for 10 - 12 mm	156
with 135° Magnetic Profile for 6 - 8 mm	156
with 180° Magnetic Profile for 10 - 12 mm	158
with 180° Magnetic Profile for 6 - 8 mm	157
with 90° Magnetic Profile for 10 - 12 mm	157
with 90° Magnetic Profile for 6 - 8 mm	113. 157. 158
with bellows for 10 - 12 mm	154

with bellows for 6 - 8 mm	154	glass/glass 180°	71
with bellows for 8 mm	154	glass/wall 90°, both sides wall mounted	70
with lateral sealing lip for 6 - 8 mm	159	glass/wall 90°, one side wall mounted	70
with lateral sealing lip for 6 mm	161	Shower Door Hinge Granada	
with lateral sealing lip for 8 mm	162	glass/glass 135°	75
with long sealing lip for 10 - 12 mm	161	glass/glass 180°	76
with long sealing lip for 6 - 8 mm	160	glass/glass 90°	75
with lower sealing lip and water deflector for 10 - 12 mm	153	glass/wall 90°, both sides wall mounted	74
with lower sealing lip and water deflector for 6 - 8 mm	153	glass/wall 90°, one side wall mounted	74
with Lower Sealing Lip for 6 - 8 mm	159	Shower Door Hinge Lugo	
with open sealing lip for 10 mm	160	glass/glass 135°, opens outwards DIN left	21
with open sealing lip for 8 mm	160	glass/glass 135°, opens outwards DIN right	21
with short sealing lip for 6 - 8 mm	161	glass/glass 180°, opens outwards DIN left	20
with water deflector and lower bellows for 6 - 8 mm	153	glass/glass 180°, opens outwards DIN right	20
with water deflector for 6 - 8 mm	158	glass/wall 90°, opens outwards DIN left	19
Shower Door Handle		glass/wall 90°, opens outwards DIN right	19
self-adhesive, single sided	140	Shower Door Hinge Madrid	
both sides	147 - 149	glass/glass 180°	12
single sided with knob	150 - 152	glass/wall 90° With chamfer, opens outwards	11
Shower door handles and knobs	139	glass/wall 90°, opens inwards	12
Shower Door Hinge Aqua		glass/wall 90°, opens outwards	11
glass/wall 90° for 6 mm	90	Original glass/glass 135°	66
glass/wall 90° for 8 mm	90	Original glass/glass 180°	65
glass/glass 180°	94	Original glass/glass 90°	66
glass/wall 90°, both sides wall mounted	93	Original glass/wall 90°, one side wall mounted	65
glass/wall 90°, one side wall mounted	93	Shower Door Hinge Next	
Shower Door Hinge Barcelona		glass/glass 180° DIN left	80
glass/glass 180°	61	glass/glass 180° DIN right	80
glass/wall 90°, both sides wall mounted	61	glass/wall 90° DIN left	79
glass/wall 90°, one side wall mounted	60	glass/wall 90° DIN right	79
Select glass / wall 90°, one side wall mounted	55	Shower Door Hinge Plan Artist	
Select glass/glass 135°	57	glass/glass 135° DIN left	85
Select glass/glass 180°	56	glass/glass 135° DIN right	85
Select glass/glass 90°	57	glass/glass 180° DIN left	84
Select glass/wall 90°, both sides wall mounted	55	glass/glass 180° DIN right	84
Select glass/wall 90°, divided mounting plate	56	glass/glass 90° DIN left	86
Shower Door Hinge Bella		glass/glass 90° DIN right	86
glass/glass 180°	16	glass/wall 90° DIN left	83
glass/wall 90° With chamfer, opens outwards	15	glass/wall 90° DIN right	83
glass/wall 90°, opens inwards	16	Shower Door Hinge Wellness®	
glass/wall 90°, opens outwards	15	glass/glass 135° / 180°, opens outwards	27
Shower Door Hinge Bilbao		glass/glass 180°, opens inwards	26
glass/glass 180°	51	glass/glass 180°, opens outwards	26
glass/wall 90°, one side wall mounted	50	glass/wall 90°, opens inwards, elongated mounting plate	25
Premium glass / wall 90°, both sides wall mounted	40	glass/wall 90°, opens inwards, one side wall mounted	24
Premium glass / wall 90°, one side wall mounted	39	glass/wall 90°, opens outwards, elongated mounting plate	25
Premium glass/glass 180°	42	glass/wall 90°, opens outwards, one side wall mounted	24
Premium glass/glass 90°	41	Premium glass/glass 135°, opens outwards DIN right	35
Premium HD glass / wall 90°, both sides wall mounted	40	Premium glass/glass 180°, opens inwards DIN left	35
Premium HD glass/glass 180°	41	Premium glass/glass 180°, opens inwards DIN right	34
Premium HD glass/wall 90°, one side wall mounted	39	Premium glass/glass 180°, opens outwards DIN left	34
Select glass / wall 90°, both sides wall mounted	45	Premium glass/glass 180°, opens outwards DIN right	33
Select glass / wall 90°, one side wall mounted	45	Premium glass/wall 90°, opens inwards DIN left	33
Select glass/glass 135°	46	Premium glass/wall 90°, opens inwards DIN right	32
Select glass/glass 180°	47	Premium glass/wall 90°, opens outwards DIN left	32
Select glass/glass 90°	46	Premium glass/wall 90°, opens outwards DIN right	31
Shower Door Hinge Easy		Shower Door Sealing Strips	153
glass/glass 135°	97	Shower Doorknob	
glass/glass 180°	98	Crystal Glass, both sides	141
glass/wall 90°, one side wall mounted	97	both sides	140 - 147
Shower Door Hinge Europe		single sided	144

Side Connector	
Bilbao glass/glass 180°	49. 53
Milano Original / Milano Premium glass/glass 180°	68
Wellness® glass/glass 180°	30
Wellness® glass/wall 180°	30
Sliding Door Systems For Showers	100
Special UV Wiping Cloths	176
Spray Head for Glass Cleaner	171
Support Profile for Sealing Strips	166
Swinging Shower Door Hinges	36

X

XtraClean Cleaning Paste

179

T

Telescopic Reinforcement Bar Set	
Bohle round ø19 glass/glass	138
Bohle round ø19 glass/wall 45°	138
Bohle round ø19 glass/wall 90°	137
Three-Point Connector	
Bohle round ø19	134
Bohle square 15x15	122
with Glass Connector Bohle round ø19	134
Threshold end caps	167
Thresholds	167. 168
Through glass connector	
Bohle round ø12	128
Bohle square 12x12	125

V

Vigo Walk-In Bonding Plate	116
Vigo Walk-In Set	115
Vigo Walk-In Shower	114

W

Wall Connector 45°	
Bohle round ø19	132
Bohle square 15x15	120
Wall Connector 90°	
Bohle round ø12	127
Bohle round ø19	130, 131
Bohle square 15x15	120
Wall connector adjustable 90° Bohle square 15x15	121
Wellness® Premium Shower Door Hinges	31
Wellness® Shower Door Hinges	23
Willach Aquant 40 Sliding Door System	105
Window Washer Economy	173
Window Washer with Fleece	182
Window Wiper Handle	183

UK & ROI Sales Conditions

1. Definitions

- Conditions: the terms and conditions set out in this document as amended from time to time in accordance with condition 2.c.
- Contract: the contract between Bohle and the Purchaser for the sale and purchase of the Products in accordance with these Conditions.
- Order: the Purchaser's order for the Products, as set out in the Purchaser's order form and/or Bohle's written record of any telephone order.
- Products: the products (or any part of them) set out in the Order.
- Purchaser: the person or firm who purchases the Products from Bohle.
- Specification: any specification for the Products, including any related plans and drawings, that is agreed in writing by the Purchaser and Bohle.
- Bohle: the supplier of the Products, Bohle Limited, registered in England and Wales with company number 00644864

2. Application

- These conditions apply to the Contract, as well as all statements made by Bohle in catalogues, brochures, price lists, quotations, on the internet or verbally, to the exclusion of any terms the Purchaser may seek to impose or which may be implied by custom, trade, practice or course of dealing. Any samples, drawings, descriptive matter, or advertising produced by Bohle and any descriptions or illustrations contained in Bohle's catalogues or brochures are produced for the sole purpose of giving an approximate idea of the Products described in them. They shall not form part of the Contract or have any contractual force.
- The Contract constitutes the entire agreement between the parties. The Purchaser acknowledges that it has not relied on any statement, promise or representation made or given by or on behalf of Bohle which is not set out in the Contract.
- Variations of these conditions are only valid if confirmed in writing.
- Placing an Order constitutes the Purchaser's acceptance of these Conditions. The Purchaser will be responsible for ensuring that the terms of the Order and any Specification submitted by the Purchaser are complete and accurate.
- Bohle may change these Conditions at its discretion [and Bohle will notify the Purchaser of any amendments to the Conditions]. For the avoidance of doubt, the Purchaser will be bound by the Conditions in force at the date of placing the relevant Order.

3. Orders/Contract

- Any Orders received (whether by mail, internet, phone or fax) will be deemed to have been accepted unless the Purchaser is otherwise notified by Bohle.

4. Price & Payment Terms

- Quotations are only valid in writing and for the stated period. A quotation shall not constitute an offer.
- The price for the Products shall be the price set out in Bohle's published price list at the date of the Purchaser's order, unless otherwise agreed in writing with Bohle.
- Bohle reserves the right to amend the specification of the Products at any time but guarantees that the amended products will deliver at least equivalent functionality and performance.
- Prices are to be understood in €(GBP) unless otherwise agreed with Bohle, net of any deductions or discounts applicable, exclusive of VAT (which shall be payable by the Purchaser in addition on receipt of a VAT invoice from Bohle), Ex-works (as defined by Incoterms 2010), excluding all other taxes, transport costs, insurance and installation. Packing, postage and freight are included in the price for orders above €150 (£200) net of VAT.
- Payments in €(GBP) shall be made to National Westminster Bank, sort code 01-05-63, account number 13364830. Payments in €(EUR) shall be made to Ulster Bank, sort code 985330, account number 08117189. Swift code and IBAN information can be found on invoices.
- Please note that deliveries of small or unwieldy orders (such as L-squares, straight edges, mirror profiles, long-lengths etc.) may result in a relatively high transport cost. Purchasers may consolidate such products with other orders and agree a transport cost with Bohle prior to delivery.
- Carriage to off-shore UK Islands will be charged extra at cost.
- Bohle reserves the right to adjust prices due to reasons beyond its control including exchange rates, production cost, duties, insurance, freight and other purchase costs (incl. for components & services). Bohle may also adjust prices if the Purchaser requests a change in delivery date, quantity or type of Products ordered, or the Specification, or if the Purchaser causes a delay due to any information or instructions given or not given by it.
- Bohle may invoice the Purchaser for the Products on or at any time after the Order is placed.
- Payment is to be made:
 - in advance by wire transfer or by irrevocable, confirmed letter of credit issued to Bohle's indicated bank or by cheque; or
 - if so agreed with Bohle in writing prior to the Purchaser placing an Order, within 30 days of the date of Bohle's invoice, subject to an agreed credit limit; or
 - if so agreed with Bohle in writing prior to the Purchaser placing an Order, by another payment method including credit or charge card. Cheques may only be accepted conditionally.
- With the exception of clause 4.i.ii, processing of any Order will not commence until clearance of funds.
- All bank charges are for the account of the Purchaser unless otherwise agreed in writing prior to Order.
- Without prejudice to any other right it may have, Bohle may suspend deliveries or service until payment is received in full.
- Any dispute in relation to a particular Order shall not entitle the Purchaser to withhold payment in relation to any other Order.
- Bohle shall be entitled to charge interest on late payments at a rate of 8% above the minimum bank rate of the European Central Bank on the amount overdue. Such interest shall accrue on a daily basis from the due date until the date of actual payment of the overdue amount, whether before or after judgment. Any costs incurred by Bohle in connection with receiving a late payment or recovering any overdue sum shall be paid by the Purchaser.

5. Delivery/Title/Risk

- Products are dispatched from such of Bohle's warehouses as is the most appropriate location for Bohle. The delivery period stated in any Order confirmation is approximate and time of delivery is not of the essence. Delays in delivery do not justify any kind of compensation except as otherwise expressly set out in these Conditions.
- Bohle will deliver the Products to the location set out in the Order or such other location as the parties may agree (Delivery Location) at any time after Bohle notifies the Purchaser that the Products are ready.
- Delivery of the Products shall be completed when the Products arrive at the Delivery Location.
- If the Products are not available or have been modified, Bohle reserves the right to supply similar products of equivalent functionality.
- Deliveries may be made in instalments and each such instalment shall constitute a separate Contract which may be invoiced separately. Any right to cancel one instalment shall not entitle the Purchaser to cancel any other instalment.
- Bohle shall be entitled to make partial delivery of any Order if, for example, certain Products are unavailable. Partial delivery shall not entitle the Purchaser to reject the Order.
- The Purchaser shall not be entitled to reject the Products if Bohle delivers up to and including [5%] more or less than the quantity of Products ordered, but a pro

rata adjustment shall be made to the Order invoice on receipt of notice from the Purchaser that the wrong quantity of Products was delivered.

- If the Purchaser refuses to accept a delivery without Bohle's agreement, he must pay Bohle's expenses or loss resulting from that refusal, including storage costs, until he accepts delivery. If the Purchaser has not accepted delivery of the Products within 10 working days of the date that Bohle originally delivered the Products to the Delivery Location, Bohle may resell or otherwise dispose of part or all of the Products and charge the Purchaser for any reasonable costs in connection with the storage and sale of the Products. If the Purchaser has paid in advance for the Products, Bohle will refund the purchase price less any such costs as well as any shortfall below the price of the Products.
- Bohle shall not be liable for any delay in delivery or failure to deliver the Products that is caused by the Purchaser's failure to provide Bohle with adequate delivery instructions or by any other act or omission of the Purchaser.
- If Bohle fails to deliver the Products, its liability shall be limited to the costs and expenses incurred by the Purchaser in obtaining replacement goods similar in description and quality in the cheapest market available, less the price of the Products.
- Risk in the Products shall pass to the Purchaser on completion of delivery.
- Title to the Products passes on receipt by Bohle of full payment. Until then, the Purchaser must:
 - hold the goods on a fiduciary basis as keep them in satisfactory condition;
 - insure and store the Products separately and keep them in satisfactory condition;
 - not modify, pledge, sell or part with possession of the Products; and
 - notify Bohle if any of the events in clause 9.b shall occur.On request the Products shall be made available to Bohle for re-collection and the Purchaser shall provide any information relating to the Purchaser as Bohle shall request. Until title in the Products has passed to the Purchaser, the Purchaser shall not purport to be the owner of the Products and shall not show such Products as stock in its accounts.
- Bohle may at any time upon reasonable notice enter the Purchaser's premises (or any other premises where the Products are stored) for the purpose of inspecting the Products and ensuring the Purchaser's compliance with this Contract. The Purchaser shall ensure that Bohle is granted access to such premises and facilities as are reasonably necessary for the purpose of this clause.
- If before title to the Products passes to the Purchaser, the Purchaser becomes subject to any of the events listed in clause 9.b, or Bohle reasonably believes that any such event is about to happen and notifies the Purchaser accordingly, then, without limiting any other right or remedy Bohle may have, Bohle may at any time require the Purchaser to deliver up the Products and, if the Purchaser fails to do so may, together with appropriate transport and personnel, promptly enter any premises of the Purchaser or of any third party where the Products are stored in order to recover them.

6. Acceptance

- Delivered Products must be inspected by the Purchaser promptly upon receipt of the Products. If the Purchaser does not claim any discrepancies in the delivery within 3 working days after receipt of the shipment, the Purchaser will be deemed to have accepted the Products in full.
- If Bohle agrees that the Purchaser may return Products, they must be in their original condition (unused, undamaged, in original packaging) and accompanied by a return note as well as proof of purchase. Any return charges must be paid by the Purchaser and a re-stocking charge of 20% of the Products value or €20 (GBP) whichever is the greater will be charged to the Purchaser for any goods returned through no fault of Bohle.
- The Purchaser may not return any Products which have been custom made to the Purchaser's specification, or where any item comprised in the Order has been specially ordered by Bohle to satisfy such Order.
- Products received in an obviously damaged condition (including damaged packaging) should be either rejected by the Purchaser on delivery, or, if signed for, then signed for as "Received in damaged condition", regardless of carrier paperwork instructions and of carrier driver information. Failure to do this will result in any claim for damage being rejected.

7. Warranty

- Subject to clause 7.c, Bohle guarantees that the Products will be free from defects for 6 months after date of invoice (Warranty Period). Should the Purchaser notify Bohle in writing within the Warranty Period of a defective product, Bohle will repair or replace the Product (at its discretion) within a reasonable time, provided that Bohle shall have reasonable opportunity to examine the Product at either the Purchaser's or Bohle's premises (at Bohle's option).
- Any return of Products must be approved by Bohle in writing before being effected and the Purchaser shall bear the cost of carriage, postage and packaging. Any shipments received by Bohle where such costs have not been paid by the Purchaser will not be accepted.
- Bohle will not accept warranty protection claims for damage caused by:
 - the Purchaser's failure to comply with Bohle's instructions (or if none are given, good industry practice) regarding the installation, use, storage, commissioning, modification or repair by the Purchaser or any unauthorised third party of the Products;
 - the Purchaser making further use of the Products after giving notice in accordance with condition 7.a;
 - Bohle following any drawing, design or Specification supplied by the Purchaser;
 - the Purchaser altering or repairing the Products without the written consent of Bohle;
 - fair wear and tear, willful damage, negligence or abnormal storage or working conditions; or
 - the Products differing from their description or specification as a result of changes made to ensure that they comply with applicable statutory or regulatory requirements.
- Except as provided in this clause 7, Bohle shall have no liability to the Purchaser in respect of the Products' failure to comply with the warranty set out in clause 7.a.
- Except as set out in these Conditions, all warranties, conditions and other terms implied by statute or common law are, to the fullest extent permitted by law, excluded from the Contract.
- These Conditions shall apply to any repaired or replacement Products supplied by Bohle.

8. Liability

- Nothing in these Conditions shall limit or exclude Bohle's liability for:
 - death or personal injury caused by its negligence, or the negligence of its employees, agents or subcontractors (as applicable);
 - fraud or fraudulent misrepresentation;
 - breach of the terms implied by section 12 of the Sale of Goods Act 1979; or
 - any matter in respect of which it would be unlawful for Bohle to exclude or restrict liability.
- Subject to clause 8.a:
 - Bohle shall under no circumstances whatever be liable to the Purchaser, whether in contract, tort (including negligence), breach of statutory duty, or otherwise, for any loss of profit, or any indirect or consequential loss arising under or in connection with the Contract; and
 - Bohle's total liability to the Purchaser in respect of all other losses arising under or in connection with the Contract, whether in contract, tort (including

negligence), breach of statutory duty, or otherwise, shall in no circumstances exceed [the lesser of] [repair or replacement of the Products] [or €(€)k]m].

9. Termination

- If the Purchaser becomes subject to any of the events listed in condition 9.b, or Bohle reasonably believes that the Purchaser is about to become subject to any of them and notifies the Purchaser accordingly, then without limiting any other right or remedy Bohle may have, Bohle may cancel or suspend all further deliveries under the Contract or under any other contract between the Purchaser and Bohle without incurring any liability to the Purchaser, and all outstanding sums in respect of Products delivered to the Purchaser shall become immediately due.
- For the purpose of condition 9.a, the relevant events are:
 - the Purchaser becomes insolvent, or an order is made or a resolution is passed for the winding up of the Purchaser (other than voluntarily for the purpose of solvent amalgamation or reconstruction), or if an administrator, administrative receiver or receiver is appointed in respect of the whole or any part of the Purchaser's assets or business, or if the Purchaser makes any composition with its creditors or takes or suffers any similar or analogous action in consequence of debt, or (if the Purchaser is an individual) is the subject of a bankruptcy petition or order, or any event which has an effect equivalent or similar occurs in any jurisdiction to which the Purchaser is subject;
 - the Purchaser suspends, threatens to suspend, ceases or threatens to cease to carry on all or substantially the whole of its business;
 - the Purchaser's financial position deteriorates to such an extent that in Bohle's opinion the Purchaser's capability to adequately fulfill its obligations under the Contract has been placed in jeopardy; and
 - (being in individual) the Purchaser dies or by reason of illness or incapacity (whether mental or physical) is incapable of managing his or her own affairs or becomes a patient under any mental health legislation.
- Bohle may terminate the Contract, including any Order placed but not yet processed, immediately upon written notice to the Purchaser if:
 - the Purchaser is in material breach of any of the terms of this Contract and fails to remedy such breach within [14] days of written notice requiring it to do so by Bohle; or
 - the Purchaser has failed to pay any sum due under this Contract by its due date and such sum remains unpaid within [14] days of written notice by Bohle requiring the Purchaser to pay such sum in full.
- All sums payable under this Contract shall, upon termination of the Contract or any relevant Order (as appropriate) become immediately due and payable.
- Upon termination of the Contract, the Purchaser shall deliver to Bohle any Products in its possession to which title has not passed to the Purchaser. Failure to do so within a reasonable time shall entitle Bohle (without prejudice to any other right or remedy available to Bohle) to enter onto the Purchaser's premises or other other premises where the Products are stored, together with appropriate transport and personnel, to repossess the Products.
- Termination of the Contract, however arising, shall not affect either of the parties' rights and remedies that have accrued at termination. Clauses which expressly or by implication survive termination of the Contract shall continue in full force and effect.

10. Force Majeure

- Bohle shall not be liable for failure or delays in delivery or service caused by circumstances beyond their reasonable control (which may include strikes, lock-outs or other industrial disputes whether involving its own workforce or a third party's), failure of energy sources or transport network, acts of God, war, terrorism, riot, civil commotion, interference by civil or military authorities, national or international calamity, armed conflict, malicious damage, breakdown of plant or machinery, nuclear, chemical or biological contamination, sonic boom, explosions, collapse of building structures, fires, floods, storms, earthquakes, loss at sea, epidemics or similar events, natural disasters or extreme adverse weather conditions, or default of suppliers or subcontractors) and Bohle will be entitled to an appropriate delivery time extension for the fulfilment of the Order.

11. Jurisdiction

- The Contract, and any dispute or claim arising out of or in connection with it or its subject matter or formation (including non-contractual disputes or claims), shall be governed by, and construed in accordance with, English law, and the parties irrevocably submit to the exclusive jurisdiction of the courts of England and Wales.





12. General

- Bohle may at any time assign, transfer, charge, subcontract or deal in any other manner with all or any of its rights or obligations under the Contract. The Purchaser may not assign, transfer, charge, subcontract or deal in any other manner with all or any of its rights or obligations under the Contract without the prior written consent of Bohle.
- Any notice or other communication given to a party under or in connection with the Contract shall be in writing, addressed to that party at its registered office (if it is a company) or its principal place of business (in any other case) or such other address as that party may have specified to the other party in writing in accordance with this clause, and shall be delivered personally, sent by pre-paid first class post, recorded delivery, commercial courier, fax or e-mail.
- A notice or other communication shall be deemed to have been received: if delivered personally, when left at the address referred to in clause 12.b; if sent by pre-paid first class post or recorded delivery, at 9:00 am on the second working day after posting; if delivered by commercial courier, on the date and at the time that the courier's delivery receipt is signed; or, if sent by fax or e-mail, one working day after transmission.
- The provisions of clauses 12.b and 12.c shall not apply to the service of any proceedings or other documents in any legal action.
- If any court or competent authority finds that any provision of the Contract (or part of any provision) is invalid, illegal or unenforceable, that provision or part-provision shall, to the extent required, be deemed to be deleted, and the validity and enforceability of the other provisions of the Contract shall not be affected. If any invalid, unenforceable or illegal provision of the Contract would be valid, enforceable and legal if some part of it were deleted, the provision shall apply with the minimum modification necessary to make it legal, valid and enforceable.
- A waiver of any right or remedy under the Contract is only effective if given in writing and shall not be deemed a waiver of any subsequent breach or default. No failure or delay by a party to exercise any right or remedy provided under the Contract or by law shall constitute a waiver of that or any other right or remedy, nor shall it preclude or restrict the further exercise of that or any other right or remedy. No single or partial exercise of such right or remedy shall preclude or restrict the further exercise of that or any other right or remedy.
- A person who is not a party to the Contract shall not have any rights under or in connection with it.

last update: 03/10/2013

Important procedures in case of transport damage

- Do not change packing or contents.
- Do not use the products!
- Inform the forwarder of the damage.
- The table below explains the important steps!
- Inform Bohle directly of the damage!
- Before accepting the delivery, make sure the number of cartons/packages is correct.
- Later claims regarding missing products can only be accepted in exceptional cases.
- Damaged or short deliveries must be reported to Bohle within 3 days of receipt of delivery.

Transport by:	Packaging damaged:	Packaging fine but contents damaged:	What we need from you:
Parcel Service 	<p>Refuse the package altogether or, when accepting the package, make a note on the delivery slip of the parcel service and inform the corresponding depot immediately.</p>	<p>Inform the corresponding depot immediately after having received the goods as otherwise there is no insurance coverage.</p>	<p>The package number and number of delivery note. Without these, an acknowledgement of the damage is not possible.</p>
Postal Service 	<p>Request a written confirmation from the post man or refuse the package.</p>	<p>Inform the corresponding post office and request their visit and confirmation of the facts. Present original package within 24 hours.</p>	<p>Damage confirmation from the Post Office. Without it processing is not possible.</p>
Train 	<p>Refuse the delivery or unpack in presence of a member of the carrier's business and request a confirmation of the facts from the goods department.</p>	<p>Inform the corresponding goods department and request their visit and confirmation of the facts. Damages must be claimed within one week.</p>	<p>An official confirmation of facts and the original consignment note with endorsement on the back. Without these, an acknowledgement of the damage is not possible.</p>
Forwarder 	<p>Refuse delivery or, when accepting, make a corresponding comment on the delivery note of the forwarder and inform the forwarder immediately.</p>	<p>Inform the forwarder immediately after receipt of the delivery as otherwise there is no insurance coverage.</p>	<p>Copy of the receipt slip with indication of damage.</p>

How to contact Bohle

United Kingdom and Ireland

Bohle Online Shop	www.bohle.com
Email	info@bohle.ltd.uk
Sales Telephone	0161 342 1100
Freephone:	0800 616151
Sales Fax	0161 344 0111
Machinery Sales & Support	0161 342 1104
Account Payments Direct	0161 342 1112
Pickup & Postal Address	Fifth Avenue, Tameside Park, Dukinfield Cheshire SK16 4PP

Office hours

Monday to Friday 8.00 am - 5.00 pm

Collecting goods

Monday to Friday 9.00 am - 3.30 pm

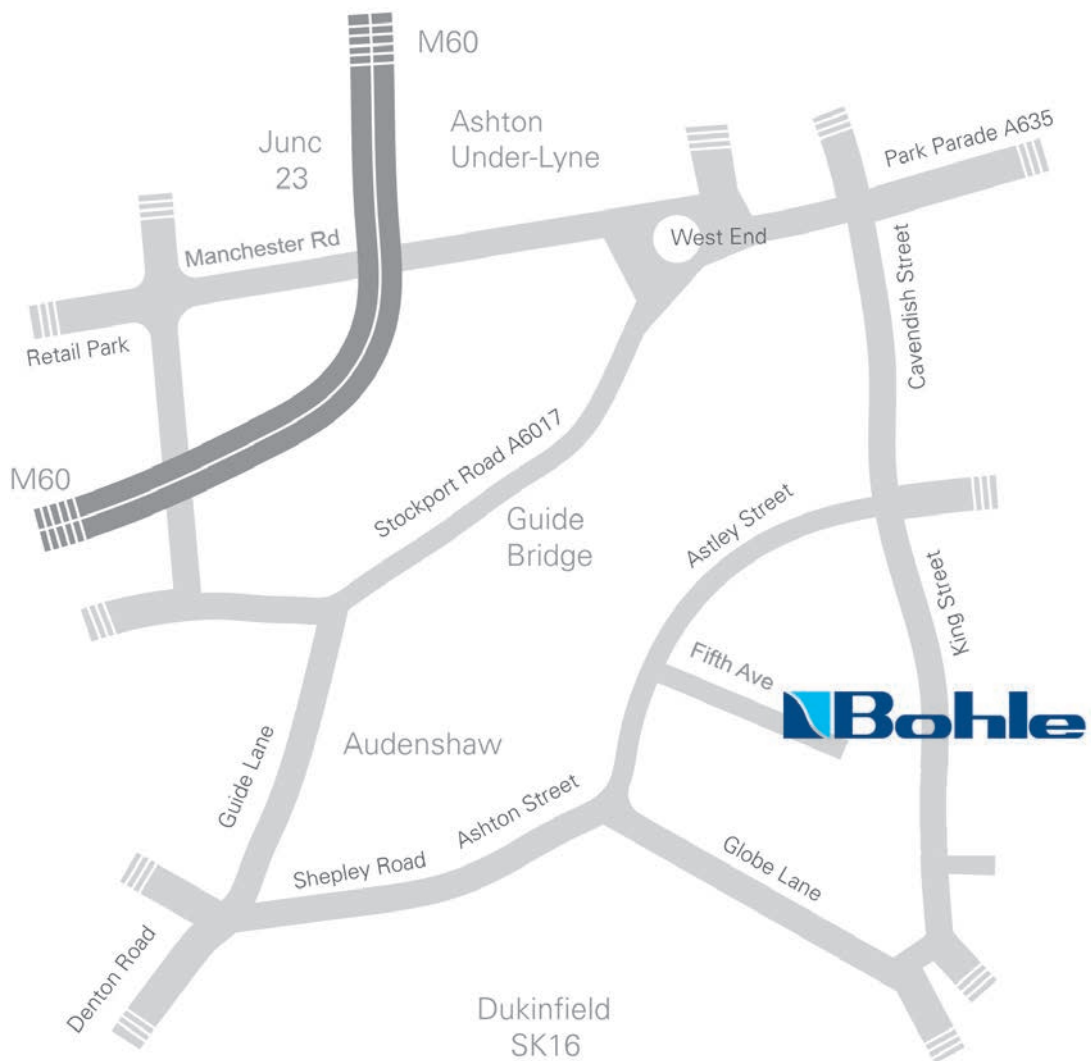

United Kingdom
Republic of Ireland

Bohle Ltd.
Fifth Avenue, Tameside Park
Dukinfield, Cheshire, SK16 4PP

T +44 161 3421100
F +44 161 3440111

info@bohle.ltd.uk
www.bohle.com